

# OPERATING MANUAL

## Protek A734

4.4  
GHz

Handheld  
Spectrum Analyzer

# INTRODUCTION

This Operating Manual represents design, specifications, overview of functions, and detailed operation procedure of Protek A734 Spectrum Analyzer, to ensure effective and safe use of the technical capabilities of the instruments by the user.

Spectrum Analyzer operation and maintenance should be performed by qualified engineers with initial experience in operating of microwave circuits and PC. Below you will find the abbreviations used in this Manual:

PC           - Personal Computer  
DUT         - Device Under Test

# CONTENTS

INTRODUCTION.....	2
1 SAFETY INSTRUCTIONS .....	10
2 GENERAL OVERVIEW .....	15
2.1 Description .....	18
2.2 Specifications .....	19
2.3 Options and Accessories .....	23
2.4 Principle of Operation .....	27
3 PREPARTION FOR USE .....	30
3.1 Power Adaptor .....	30
3.2 Battery.....	31
3.3 Front Panel .....	37
3.4 Top Panel.....	44
3.5 Side Panel.....	46
4 Operation and Function.....	50
4.1 Freq (Frequency).....	53
4.1.1 Center Freq(F1) .....	55
4.1.2 Start Freq(F2) .....	59
4.1.3 Stop Freq(F3) .....	62
4.1.4 CF Step(F4) .....	66
4.2 Span.....	69
4.2.1 Set Span(F1) .....	71
4.2.2 Full Span(F2) .....	76
4.2.3 Zero Span(F3) .....	78
4.3 Amp (Amplitude) .....	81
4.3.1 Ref Level(F1) .....	83
4.3.2 Scale/Div(F2) .....	88
4.3.3 Unit(F3) .....	89
4.3.4 Atten(F4) .....	92
4.3.5 Preamp(F5) .....	94
4.3.6 Ref Offset(F6) .....	96
4.4 BW/SWP (Bandwidth/Sweep) .....	99
4.4.1 RBW(F1) .....	101
4.4.2 VBW(F2) .....	105
4.4.3 SWP Type(F3).....	109
4.4.4 SWP Time(F4) .....	113

4.4.5	Detector(F5)	116
4.4.6	Ref. Clock(F6)	119
4.5	Marker	122
4.5.1	Marker(F1)	125
4.5.2	Normal(F2)	126
4.5.3	Delta(F3)	130
4.5.4	Off(F4)	135
4.5.5	Marker →CF(F5)	136
4.5.6	Marker All Off(F6)	138
4.6	Trace	139
4.6.1	Trace(F1)	141
4.6.2	Clear Write(F2)	142
4.6.3	Max Hold(F3)	144
4.6.4	Hold(F4)	146
4.6.5	Off(F5)	147
4.6.6	Average(F6)	148
4.7	Peak	150
4.7.1	Peak Search(F1)	153
4.7.2	Next Peak(F2)	154
4.7.3	Peak→CF(F3)	156
4.8	Meas (Measure)	158
4.8.1	Measure Off(F1)	160
4.8.2	Ch Power(F2)	161
4.8.3	ACP(F3)	165
4.8.4	Harmonic(F4)	168
4.8.5	Phase Noise(F5)	170
4.8.6	Demod(F1)	171
4.8.7	Pwr Sensor(F2)	174
4.9	System	185
4.9.1	File(F1)	187
4.9.2	Setting(F2)	198
4.9.3	Lo/Re(F3)	213
4.9.4	SW Upgrade(F4)	216
4.9.5	Information(F5)	218
4.9.6	Preset(F1)	220
4.9.7	Limit Line(F2)	226
5	WARRANTY INFORMATION	240

# Figure

Figure 2-1 A734 Hand-Held Spectrum Analyzer .....	18
Figure 2-2 A734 Option & Accessories .....	23
Figure 2-3 A734 Block-diagram .....	27
Figure 3-1 Connecting the power adaptor .....	30
Figure 3-2 Battery .....	31
Figure 3-3 A734 bottom view .....	33
Figure 3-4 Battery Charger Cradle .....	34
Figure 3-5 A734 Front View .....	37
Figure 3-6 A734 Top View .....	44
Figure 3-7 A734 Side View .....	46
Figure 4-1 Main Window .....	50
Figure 4-2 Frequency Control Key .....	53
Figure 4-3 Frequency Menu-tree .....	54
Figure 4-4 Center Frequency Control (Up/Down Key & Rotary) .....	58
Figure 4-5 Span Control Key .....	69
Figure 4-6 Span Menu-tree .....	70
Figure 4-7 Span Control (Up/Down Key & Rotary) .....	74
Figure 4-8 Amplitude Control Key .....	81
Figure 4-9 Amplitude Menu-tree .....	82
Figure 4-10 Reference Level Control (Up/Down Key & Rotary) .....	86
Figure 4-11 Bandwidth & Sweep Control Key .....	99
Figure 4-12 BW/SWP Menu-tree .....	100
Figure 4-13 RBW Control (Up/Down Key & Rotary) .....	103
Figure 4-14 VBW Control (Up/Down Key & Rotary) .....	107
Figure 4-15 SWP Time Menu-tree .....	113
Figure 4-16 Detector Menu-tree .....	116
Figure 4-17 Marker Control Key .....	123
Figure 4-18 Marker Menu-tree .....	124
Figure 4-19 Marker Control (Up/Down Key & Rotary) .....	129
Figure 4-20 Delta Marker Control (Up/Down Key & Rotary) .....	134
Figure 4-21 Trace Control Key .....	139
Figure 4-22 Trace Menu-tree .....	140
Figure 4-23 Average Menu-tree .....	148
Figure 4-24 Peak Control Key .....	151
Figure 4-25 Peak Menu-tree .....	151
Figure 4-26 Measure Control Key .....	158
Figure 4-27 Measure Menu-tree .....	159

Figure 4-28 Channel Power Menu-tree .....	161
Figure 4-29 ACP Menu-tree .....	165
Figure 4-30 Demodulation Menu-tree .....	172
Figure 4-31 Power Sensor Menu-tree.....	174
Figure 4-32 System Control Key .....	185
Figure 4-33 System Menu-tree.....	186
Figure 4-34 File Menu-tree .....	188
Figure 4-35 Save Menu-tree .....	190
Figure 4-36 Load Menu-tree .....	192
Figure 4-37 Manager Menu-tree.....	194
Figure 4-38 Setting Menu-tree.....	198
Figure 4-39 Date/Time Menu-tree .....	200
Figure 4-40 IP Set Menu-tree .....	207
Figure 4-41 Sound Menu-tree.....	210
Figure 4-42 Volume Control (Up/Down Key & Rotary).....	212
Figure 4-43 Local & Remote Menu-tree .....	214
Figure 4-44 Preset Menu-tree .....	220
Figure 4-45 Load Type Menu-tree .....	222
Figure 4-46 Limit Line Menu-tree.....	226

## Table

Table 2-1 A734 Specifications .....	19
Table 2-2 Option & Accessory Descriptions.....	24
Table 3-1 External Power Indicator LED .....	35
Table 3-2 Battery Charging Status LED .....	35
Table 3-3 Environment Specifications.....	36
Table 3-4 Character Assignment .....	41
Table 4-1 Main Window Descriptions.....	50
Table 4-2 Frequency Menu Descriptions.....	54
Table 4-3 Changing Center Frequency (with Numeric Key) .....	56
Table 4-4 Center Frequency Active & De-active .....	57
Table 4-5 Changing Center Frequency (Up/Down Key & Rotary knob) ...	58
Table 4-6 Changing Start frequency .....	61
Table 4-7 Start Frequency Active & De-active .....	62
Table 4-8 Changing Stop Frequency.....	65
Table 4-9 Stop Frequency Active & De-active.....	65
Table 4-10 Changing CF Step.....	67
Table 4-11 CF Step Active & De-active.....	68

Table 4-12 Span Menu Descriptions.....	70
Table 4-13 Changing Set Span (with number keys) .....	73
Table 4-14 Set Span Active & De-active.....	73
Table 4-15 Changing Span (Up/Down Key & Rotary knob) .....	75
Table 4-16 Changing Zero Span (number keys) .....	80
Table 4-17 Zero Span Active & De-active.....	80
Table 4-18 Amplitude Menu Descriptions .....	82
Table 4-19 Changing Ref Level (number keys).....	85
Table 4-20 Ref Level Active & De-active.....	85
Table 4-21 Changing Ref Level (Up/Down Key & Rotary knob) .....	86
Table 4-22 Changing Ref Offset (number keys) .....	98
Table 4-23 Ref Offset Active & De-active.....	98
Table 4-24 BW/SWP Menu Descriptions.....	100
Table 4-25 RBW Active & De-active.....	104
Table 4-26 RBW Manual Changing (Up/Down Key & Rotary knob).....	104
Table 4-27 VBW Active & De-active.....	108
Table 4-28 Changing VBW Manually (Up/Down Key & Rotary knob) ...	108
Table 4-29 Ext. Trigger Setting .....	112
Table 4-30 Trigger Descriptions .....	112
Table 4-31 Marker Menu Descriptions.....	124
Table 4-32 Changing Normal Marker Frequency (with number keys) ...	128
Table 4-33 Normal Active & De-active .....	128
Table 4-34 Changing Normal Marker Frequency (Up/Down Key & Rotary knob) .....	129
Table 4-35 Changing Delta Marker Frequency (with number keys) .....	132
Table 4-36 Delta Active & De-active .....	133
Table 4-37 Changing Delta Marker Frequency (Up/Down Key & Rotary knob) .....	134
Table 4-38 Trace Menu Descriptions.....	140
Table 4-39 Peak Menu Descriptions .....	152
Table 4-40 Measure Menu Descriptions .....	159
Table 4-41 Power Sensor Menu Descriptions.....	174
Table 4-42 System Menu Descriptions.....	186
Table 4-43 File Menu Descriptions .....	188
Table 4-44 Manager Menu Descriptions.....	194
Table 4-45 Setting Menu Descriptions.....	198
Table 4-46 Date & Time Menu Descriptions.....	200
Table 4-47 IP Set Menu Descriptions .....	207
Table 4-48 Sound Menu Descriptions.....	210
Table 4-49 Volume Control (Up/Down Key & Rotary knob) .....	212

Table 4-50 Volume Control Step .....	213
Table 4-51 Lo/Re Menu Descriptions.....	214
Table 4-52 Preset Menu Descriptions .....	221
Table 4-53 Load Type Menu Descriptions .....	222
Table 4-54 Limit Line Menu Descriptions.....	226



1

**SAFETY  
INSTRUCTION**

OPERATING  
MANUAL

# 1. SAFETY INSTRUCTIONS

Carefully read through the following safety instructions before putting the Analyzer into operation. Observe all the precautions and warnings provided in this Manual for all the phases of operation, service, and repair of the Analyzer.

The Analyzer must be used only by skilled and specialized staff or thoroughly trained personnel with the required skills and knowledge of safety precautions.

The protection provided by the equipment may be impaired if the equipment is used in a manner not specified by the manufacturer.

A734 is tested in stand-alone condition or in combination with the accessories supplied by GSI against the requirement of the standards described in the Certificate of Compliance. If it is used as a system component, compliance of related regulations and safety requirements are to be confirmed by the builder of the system.

Never operate the Analyzer in the environment containing inflammable gasses or fumes.

Operators must not remove the cover or part of the housing. The Analyzer must not be repaired by the operator. Component replacement or internal adjustment must be performed by qualified maintenance personnel only.

Never operate the Analyzer if the power cable is damaged.

Never connect the test terminals to mains.

If the equipment is used in a manner not specified by the manufacturer, the protection provided by the equipment may be impaired.

Electrostatic discharge can damage your Analyzer when connected or disconnected from the DUT. Static charge can build up on your body and damage the sensitive circuits of internal components of both the Analyzer and the DUT. To avoid damage from electric discharge, observe the

following:

- Always use a desktop anti static mat under the DUT.
- Always wear a grounding wrist strap connected to the desktop anti static mat via daisy-chained 1 MΩ resistor.

Observe all the general safety precautions related to operation of equipment powered by mains.

The definitions of safety symbols used on the instrument or in the Manual are listed below.

### **Caution.**



Refers to the Manual if the instrument is marked with this symbol.

This sign denotes a hazard. It calls attention to a procedure, practice, or condition that, if not correctly performed or adhered to, could result in injury or death to personnel.

---

### **Notice.**



This sign denotes important information. It calls attention to a procedure, practice, or condition that is essential for the user to understand.



**Direct current.**



**Alternating current**

- The equipment should be operated using the supplied Power

Adaptor.

- The power connection plug must only be plugged into a two-pin grounded socket!
- Do not use any battery except for specified battery.
- Li-Ion batteries must not be exposed to high temperatures or fire.
- Keep batteries away from children.
- Do not short-circuit the battery.
- Li-Ion batteries are suitable for environmentally-friendly disposal or specialized recycling.
- If the battery is replaced improperly, there is danger of explosion.
- Never use solvents such as thinners, acetone and similar things, as they may damage the front panel labeling or plastic parts

## ■ **Cleaning**

- This section provides the cleaning instructions required for maintaining the proper operation of your Spectrum.
- To remove contamination from parts other than test ports and any connectors of the Spectrum, wipe them gently with a soft cloth that is dry or wetted with a small amount of water and wrung tightly.
- It is essential to keep the test ports always clean as any dust or stains on them can significantly affect the measurement capabilities of the instrument. To clean the test ports (as well as other connectors of the Analyzer), use the following procedure:
  - using compressed air remove or loosen the contamination particles;
  - clean the connectors using a lint-free cleaning cloth wetted with a small amount of ethanol and isopropyl alcohol (when cleaning a female connector, avoid snagging the cloth on the center conductor contact fingers by using short strokes);
  - dry the connector with low-pressure compressed air.
- Always completely dry a connector before using it.

- Never use water or abrasives for cleaning any connectors of the Analyzer.
- Do not allow contact of alcohol to the surface of the insulators of the connectors.
- When connecting male-female coaxial connectors always use a calibrated wrench.



### **Caution**

Never perform cleaning of the instrument if the power cable is connected to the power outlet.

Never clean the internal components of the instrument.

- **Storage**

Before first use store your equipment in the factory package at environment temperature from 0 to +50°C and relative humidity up to 95% (at 25 °C).

After you have removed the factory package store the equipment at environment temperature from +10 to +35°C and relative humidity up to 80% (at 25 °C).

Ensure to keep the storage facilities free from dust, fumes of acids and alkalis, aggressive gases, and other chemicals, which can cause corrosion

## Support Center

+82-32-1688-6820

GS Instruments Co., Ltd.  
70, Gilpa-ro 71beon-gil, Nam-gu, Incheon,  
402-854, Korea

Product Information and Technical Assistance

[www.gsinstrument.com](http://www.gsinstrument.com)

[isale@gsinstrument.com](mailto:isale@gsinstrument.com)

---

# Certificate

Alt (cm 11)

ZERTIFIKAT ◆ CERTIFICATE ◆ CERTIFICADO ◆ CERTIFICAT

인증기관인 TÜV SÜD

  
Product Service

## Attestation of Compliance

No. E8N 13 10 56328 009

**Holder of Certificate:** GS Instruments Co., Ltd.  
1385-14, Juan-Dong, Nam-Ku  
Incheon 402-200  
REPUBLIC OF KOREA

**Name of Object:** Electronic measuring equipment  
(Hand Held Spectrum Analyzer)

**Model(s):** A734

**Description of Object:** Power Source: Li-Ion Rechargeable Battery 7.4 V  
Power Adapter: AC-DC Adapter DC 12.V / 3.5 A

**Tested according to:** EN 61326-1:2006

This Attestation of Compliance is issued according to the Directive 2004/108/EC relating to electromagnetic compatibility on a voluntary basis. It confirms that the listed apparatus complies with all essential requirements of the EMC directive and applies only to the sample and its technical documentation submitted to TÜV SÜD Product Service GmbH for testing and certification. See also notes overleaf.

**Test report no.:** RAPA13-O-686

**Date,** 2013-10-25 (Kang-Min Rhoo)

**CE** After preparation of the necessary technical documentation as well as the EC conformity declaration the required CE marking can be affixed on the product. Other relevant directives have to be observed.

Page 1 of 1

TÜV SÜD Product Service GmbH · Zertifizierstelle · Ridlerstraße 65 · 80339 München · Germany

TUV®



Product Service

## Attestation of Compliance

No. N5 13 11 56328 011

**Holder of Certificate:** **GS Instruments Co., Ltd.**

1385-14, Juan-Dong, Nam-Ku  
Incheon 402-200  
REPUBLIC OF KOREA

**Product:** **Electrical eq. for measurement, control and laboratory use (Hand Held Spectrum Analyzer)**

**Model(s):** **A734**

**Parameters:**

Rated input voltage:	12 V d.c.
Rated input current:	3A
Degree of protection against ingress of liquids:	IPX0

Remark  
External Power supply  
Manufacturer: FSF Group Inc.  
Type: FSP060-DBAE1

**Tested according to:** EN 61010-1:2010

This Attestation of Compliance is issued on a voluntary basis for electrical equipment below the voltage limits of Low Voltage Directive 2006/95/EC (previous 73/23/EEC). The essential requirements are fulfilled accordingly. It refers to the particular sample submitted for testing and certification only. See also notes overleaf.

**Test report no.:** CPSA01384613

**Date,** 2013-11-12

(Hyuk-Jun Kwon)



Other relevant European directives have to be observed. If they require CE marking it may be affixed on the product after preparation of the necessary technical documentation as well as the declaration of conformity.

Page 1 of 1



# 2

## **GENERAL OVERVIEW**

OPERATING  
MANUAL

## 2 GENERAL OVERVIEW

### 2.1 Description

A734 is Hand-Held type spectrum analyzer with a frequency range of 100 kHz to 4.4 GHz.

This equipment is suitable for signal analysis which can be used as frequency, digital information are more important these days.

A734 Hand-Held Spectrum Analyzer has been designed for use in the process of development, adjustment and testing of various electronic devices in industrial and laboratory facilities, including operation as a component of an automated measurement system.

The equipment provides a variety of functions and user-friendly interface so user can operate for management and test about frequency and amplitude.



Figure 2-1 A734 Hand-Held Spectrum Analyzer

## 2.2 Specifications

Protek A734 has wide frequency range of 100 kHz to 4.4 GHz and provides analysis ability which can measure low level RF signal with preamp. The equipment has low power consumption so that A734 can operate for 8 hours with the battery.

**Table 2-1 A734 Specifications**

Item		Specification
<b>Frequency</b>	Range	100 kHz to 4.4GHz
	Span Mode	Center Freq + Span or Start Freq + Stop Freq ,ZERO Span
	Span	ZERO SPAN , 600 Hz to 4.4GHz
	Minimum Span	600 Hz
	Internal Frequency Reference Accuracy	±1PPM
	Frequency Readout Accuracy	Reference error ±1 sample <sup>1</sup>
	Marker Accuracy	Reference error ±1 sample
	RBW	Span ∅   dependent 0.1Hz to 250kHz & 5MHz(0.1, 0.2, 0.4 ,0.8, 1.6, 3.2, 6.5, 13, 25, 50, 100 Hz or kHz)
<b>Amplitude</b>	Measurement Range	DANL - 1dB Gain Compression 1dB Gain Compression(attenuator 15dB, preamp off) +16dBm Typical, 1Hz to 150MHz +19dBm Typical, 150MHz to 4.4GHz
	DANL	Displayed Average Noise Level : 0dB ATT, 1Hz RBW
	FREQ	Preamp OFF      Preamp ON

<sup>1</sup> 1 sample represents approximately 40% of the selected RBW.

	10Hz	-124dBm	NA
	100Hz to 10kHz	-130dBm	NA
	10kHz to 500kHz	-142dBm	NA
	500kHz to 10MHz	-142dBm	-153dBm
	10MHz to 100MHz	-148dBm	-161dBm
	100MHz to 1GHz	-144dBm	-158dBm
	1GHz to 2.6GHz	-139dBm	-151dBm
	2.6GHz to 3.3GHz	-135dBm	-151dBm
	3.3GHz to 4.4GHz	-128dBm	-134dBm
Amplitude unit	dBm, Watt		
Absolute Accuracy (ref level < 0dBm)	±1.5dB Typical		
Absolute Accuracy (0dBm < ref level < 10dBm)	±1.5dB		
Relative Accuracy (ref level < 0dBm)	±0.25		
Maximum Safe Input Level ( preamp off, 15dB att)	+20dBm		
DC Volt	±0.2V max		
<b>Sweep</b>	Zero Span Sweep Time	10 ms to 2 sec ( ±0.1% ) All other sweep times are estimates reported after sweep completes	
	Sweep Triger	freerun, single, external	
	External Trigger	3.3V CMOS/TTL input	
<b>Display</b>	TRACE	3 Trace	

	DETECTOR	min, max, sample, avg ( power , voltage , log )	
	Marker	5 Marker	
	Marker function	peak, next peak, center=marker frequency,	
	Audio Demodulation	AM & FM	
	Type	5.7" Color TFT-LCD 640*480 pixels	
	Display Resolution	640*480 pixels	
	Feature	SunLight Readable	
	KeyPad Back Light	ON/OFF	
<b>Input</b>	RF Connector	RF Signal IN, N type Female 50OHM	
	BNC External Timebase	10MHz in, BNC type Female	
	BNC Share	Self test, Sync out, Sweep Trigger IN, BNC type Female	
<b>General Spec</b>	Operating Environment	-10°C to +50°C < 95%	
	Humidity	< 95%	
	Storage Temperature	-20°C to +60°C	
<b>Power</b>	Battery	Li-ion Rechargeable Battery 6Cell(normal 7.4V / 7800mA)	
	Power Adaptor	AC Input	AC 100-240 V- ,50/60 Hz, 1.5A
		DC Output	DC 12Vd.c. / 5.0A
<b>Dimension</b>	Size	160(W) X 263(H) X 61(D) mm	
<b>Weight</b>		1.75 Kg (include battery)	
<b>Other</b>	Speaker	0.5W 8ohm Speaker 1Ch	
	AF out		
	Interface	Storage (USB port), LAN (RJ-45 Port)	
<b>Environmental</b>		For Indoor use	
		Altitude up to 2000m	
		Pollution Degree 2°	

## Highlight of the Product

- Wide Frequency Range (100 kHz to 4.4GHz)
- 5.7 Inch TFT Color LCD can be easily read (640\*480)
- Smart Battery management can be check Battery capability
- Battery Powered Operation for 8 Hour
- Key pad Back Light function
- Sun-Light Readable LCD for readability
- Light weight (1.75Kg) increase portability
- Cortex A8 1GHz CPU Platform

## 2.3 Options and Accessories

### Unpacking the Instrument

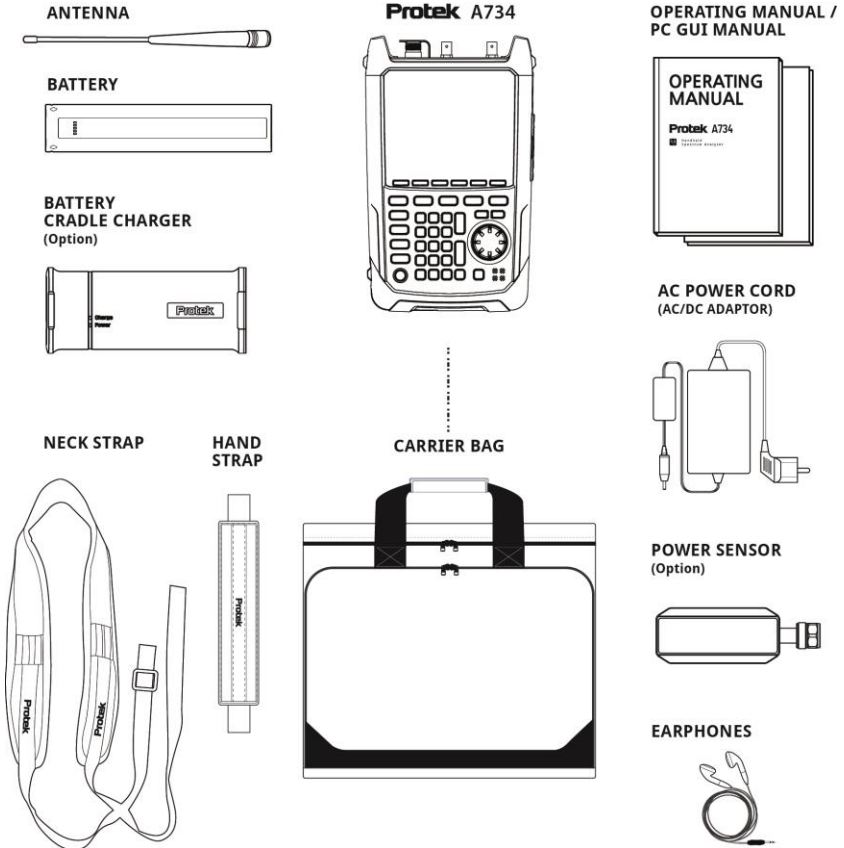

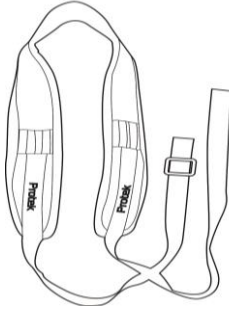

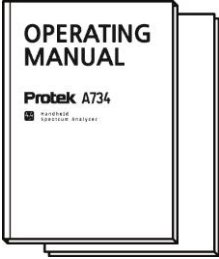

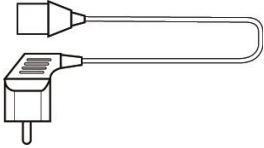
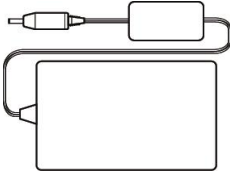
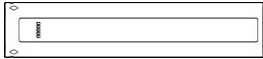
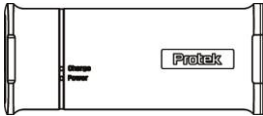

Figure 2-2 Options & Accessories

**Table 2-2 Option & Accessory Descriptions**

Description	Picture	Specification
Soft Carrying Case	 A line drawing of a soft carrying case. It features a rectangular shape with rounded corners and a handle on top. A latch is visible in the center of the top edge. The case is shown from a front-facing perspective.	
Neck Strap	 A line drawing of a neck strap. It consists of a long, thin strap with a buckle at one end. The strap is shown in a looped configuration. The brand name 'Protek' is printed vertically on the strap.	
Hand Strap	 A line drawing of a hand strap. It is a long, narrow strap with a buckle at one end. The brand name 'Protek' is printed vertically on the strap.	



<p>Hard copy</p>		<p>Operating Manual PC GUI Manual</p>
<p>Earphone</p>		<p>Stereo</p>
<p>Antenna</p>		
<p>AC Power Cord</p>		<p>6FT(1.8MM) 220V BLACK</p>
<p>AC-DC Adapter</p>		<p>AC Input: 100- 240V-,1.5A DC Output: 12Vdc, 5A MAX</p>
<p>Li-ion Battery</p>		<p>Nominal Voltage: 7.4Vdc Capacity: 7800mAh</p>
<p>Battery Charger</p>		<p>DC Input: 12Vdc, 3A DC Output: 8.3Vdc, 2.5A</p>

Power Sensor

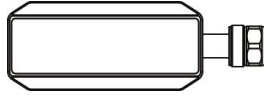

Frequency Range

: 20Mhz to 3.8GHz

Sensor Type : Average

Peak Power Sensor

: -40dBm to +10dBm

Accuracy :  $\pm 7\%$

Test Port : Precision N  
Female

## 2.4 Principle of Operation

A734 Spectrum Analyzer consists of the Analyzer Unit, and some supplementary accessories. The Analyzer Unit includes internal computer, display, and keypad. The block diagram of the Analyzer is represented in figure 3.

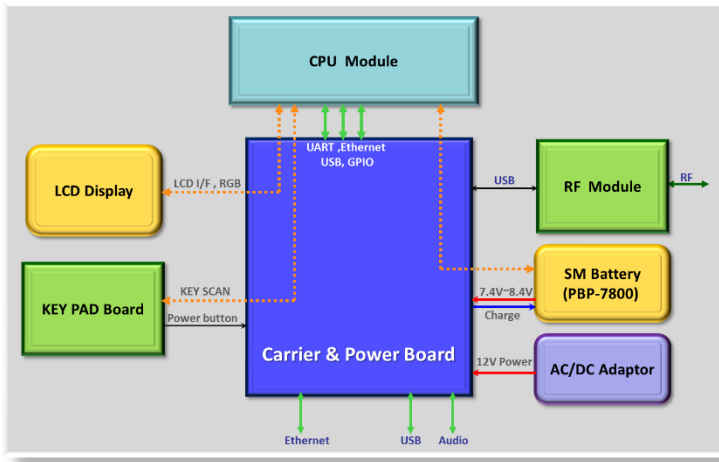

Figure 2-3 A734 Block-diagram

The Analyzer Unit consists of CPU module, carrier board, RF module, LCD, keypad board, rotary board, speaker, audio jack, battery, and AC/DC adaptor.



# 3

## **PREPARTION FOR USE**

OPERATING  
MANUAL

## 3 PREPARTION FOR USE

### 3.1 Power Adaptor

The Equipment uses following Power Supply.

- Product: Switching Power Supply Adaptor
- Model no. FSP060-DBAE1
- AC INPUT: 100-240 V-, 1.5 A, 50-60 Hz
- DC OUTPUT: 12.0 Vdc 5.0A MAX
- Manufactured by: Zhonghan Electronics (Shenzhen)
- Trade mark: FSP GROUPINC



Figure 3-1 Connecting the power adaptor

## 3.2 Battery

A734 uses CE, UL certificated PBP-7800 Battery.



Figure 3-2 Battery

### Caution



RISK OF EXPLOSION IF BATTERY IS REPLACED BY AN INCORRECT TYPE.

DISPOSE OF USED BATTERIES ACCORDING TO THE MANUFACTURER'S INSTRUCTIONS.

- If the “push” button on the battery is pressed, the remained battery volume will be displayed in the battery icon next to the “push” button.
- Each level of the battery indicator takes 20% of the battery portion. If the battery level is three, it means the battery is charged 40% - 60%.
- As illustrated below, please insert the battery pack while the printed label is on the upside.
- Non rechargeable Li-Ion battery was in analyzer
- This non rechargeable Li-Ion battery is CR02032(made by Hitachi Maxwell Ltd)

- **Caution**
  - Avoid placing the battery pack near heating sources or on the place near windows.
  - Do not store the battery pack in the high humidity.
  - If the battery is unused for a long time, separate it from the unit.
  - Keep this battery pack away from children.
  - If electrolyte from the battery pack is leaking or the battery pack smells strangely, keep the battery pack away from fire.
  - In case that electrolyte from the battery pack is touched by any part of the human body, wash it immediately and go to hospital to prevent potential damage.
  - Use the authorized charger only.
  - Do not abandon the battery pack in the car in the summer.
  - Avoid any shock to the battery pack
  - Do not replace non rechargeable Li-Ion battery except for certified person
  - This battery has about ten-month warranty.



# Installing a Battery

Caution: Full charge the battery before first using the analyzer.



Figure 3-3 A734 bottom view

1	Open the battery cover.
2	Insert the battery (Observe correct battery polarity orientation when installing).
3	Close the battery cover.

## Charging a Battery

You may charge the battery both in the analyzer and in the external battery charger cradle.

1	Insert the battery in the analyzer.
2	Plug in the AC- DC adapter and switch on the external power.
3	The charge indicator icon on the screen, indicating that the battery is charging and is fully charged.

During charging and discharging, the battery voltage, current, and temperature are monitored. If any of the monitored conditions exceed their safety limits, the battery will terminate any further charging or discharging until the error condition is corrected.

Protek A734 has another battery charging method which uses Battery Charger Cradle.



Figure 3-4 Battery Charger Cradle

- Product: Battery Charger
- Model no. C122R5
- DC INPUT: +12Vdc(+11Vdc to +29Vdc)
- Manufactured by: GS Instruments Co., Ltd.

- **Applicable Scope**

- The battery charger equipment is used to supply stable DC power to charge the external battery pack. The input voltage of battery charger equipment is +12 Vdc(+11 to +29 Vdc) and the output voltage of battery charger equipment is +8.3 Vdc  $\pm$  0.1Vdc

- **LED Status**

- EXTERNAL POWER CONNECT LED

**Table 3-1 External Power Indicator LED**

	DC-JACK Connect	DC-JACK not connect
3 $\phi$ LED(GREEN)	ON	OFF

- Charging / Charging Complete LED

**Table 3-2 Battery Charging Status LED**

	Charging	Charging Complete
3 $\phi$ LED(Bi-Color)	RED ON	GREEN ON

- Environment Spec

**Table 3-3 Environment Specifications**

NO	Item	Spec	Note
1	Operating Temperature	0°C-50°C	Full Load
2	Operating Humidity	0%-90%	Condition

### 3.3 Front Panel

The front view of A734 is represented in figure 3-5. The front panel is equipped with the following parts:

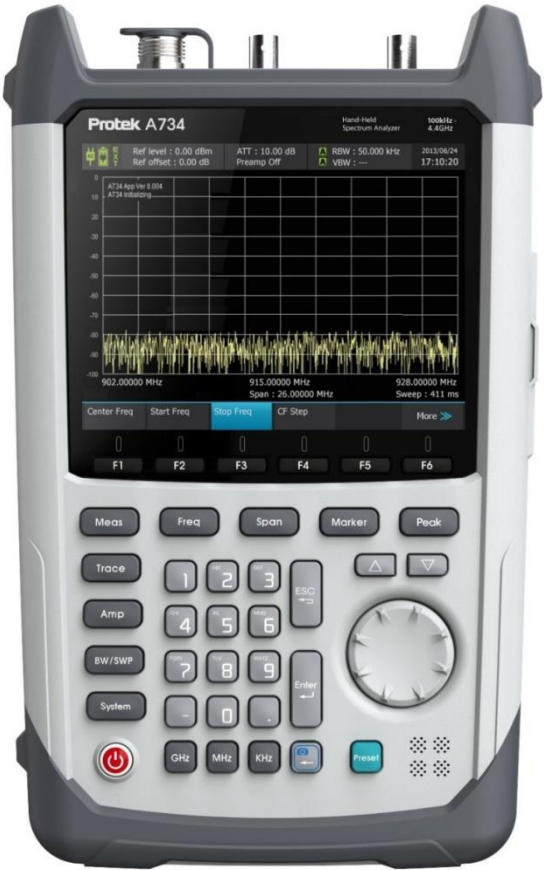

Figure 3-5 A734 Front View

## POWER SWITCH key

---



«POWER SWITCH» toggles between On and Off states of the Analyzer.

---

### Note

Holding the key for more than 3 seconds on an operating Analyzer will turn off the power supply

---

### CAUTION

Do not disconnect the power cable from the mains when the Analyzer is operating. This can damage the Analyzer software.

---

## PRESET key

---



«PRESET» key restores the initial condition of the Analyzer.

---

## Display

---

The Analyzer is equipped with sun-light readable 5.7” color LCD. The display consists of the control elements and area for measurement result indication.

---

## Soft keys

---



The assignment of functional hard keys is determined by a current soft key panel displayed along the upper side of the screen.

---

## Function keys

---

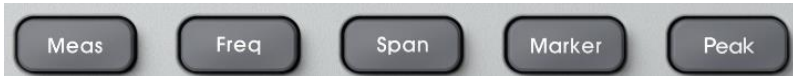

The control keys enable you direct access to the control functions of the Analyzer. They allow the user to access a specific function by pushing just one key.

---

## ESC key

---

«ESC» key is used for the following:



- If there is an active data entry field, this key cancels all the data entered in the field and restores the value of the field as it was before any new numbers or characters were entered.
  - If there is no active data entry field, this key brings the user back to an upper level of the soft key menu.
- 

## ENTER key

---

«ENTER» key is used for the following:



- If there is an active data entry field, this key completes the entry process and assigns the new value to the field.
  - If there is no active data entry field, this key enables the function of a highlighted soft key.
-



## Alphanumeric keys

---



Using the alphanumeric keys, you can enter numeric values or characters. The alphanumeric keys include the numbers from 0 to 9, the alphabet, a minus sign and dot.

Each key covers one number and more than one character with the first choice being a character. If you need to enter a character, press the key several times until the character you require is selected. The following table shows an overview of character assignment.

**Table 3-4 Character Assignment**

Key	1.	2.	3.	4.	5.
1	1				
2	2	A	B	C	
3	3	D	E	F	
4	4	G	H	I	
5	5	J	K	L	
6	6	M	N	O	
7	7	P	Q	R	S
8	8	T	U	V	
9	9	W	X	Y	Z
0	0				
-	-				
.	.				

## CAPTURE / BACK key

---

«CAPTURE / BACK» key is used for the following:



- «CAPTURE» key is used to capture the screen.
- If there is an active data entry field, this key completes the entry process and assigns the new value to the field.

---

## UNIT keys



«GHz» key is used for completion of a decimal number entry by adding the GHz ( $\times 10^9$ ).



«MHz» key is used for completion of a decimal number entry by adding the MHz ( $\times 10^6$ ).

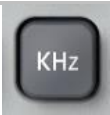

«kHz» key is used for completion of a decimal number entry by adding the kHz ( $\times 10^3$ ).

---

## CURSOR key

---

«UP» and «DOWN» CURSOR keys are used for the following:



- If there is an active numeric data entry field, these keys scroll up and down the list of the available numeric values. «UP» arrow increases the value, «DOWN» arrow decreases the value.
- 

## ROTARY KNOB

---

The rotary knob is used for the following:



- If there is an **active** numeric data entry field, the rotary knob scrolls up and down the list of the available numeric values. Clockwise rotating increases the value, counterclockwise rotating decreases the value.
-

### 3.4 Top Panel

The top view of A734 is represented in figure 3-6. The top panel is equipped with the following parts:



Figure 3-6 A734 Top View

#### INPUT Connector (50 Ω)



Accepts an external input with a frequency range from 100 kHz to 4.4 GHz.

- 0 VDC +20dBm MAX

## SELF TEST Connector

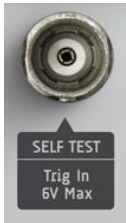

To use the self test, connect the SELF TEST to the INPUT.

This checks the attenuator, mixers, broadband power detector, RF and IF signal paths, and I/Q demodulator

DC 6V Max

## 10MHz REF IN Connector



10MHz Reference input, automatically detected after each sweep completes.

Use a clean 10 MHz reference with  $>0$  dBm level.

+13 dBm is recommended

### 3.5 Side Panel

The side view of A734 is represented in figure 3-7. The side panel is equipped with the following parts:



Figure 3-7 A734 Side View

## DC Power Connector

---



Provides input for the DC power source via an AC-DC adapter

In case of emergency, to avoid danger of electric shock or the like, pull the power cable out of the power outlet or the DC power connector of the instrument.

- 12V  3.0A
- 

## Earphone Jack

---



Connects to a earphone

- Stereo Earphone
- 

## USB Port

---



USB ports allow connection of various external USB compatible devices, such as flash memory stick and Power Sensor.

- 5V  500mA
  - Standard Type A
-

## Ethernet Port

---



Ethernet port allows the user to connect the Analyzer to a LAN (Local Area Network). This connection enables the user to control the instrument using an external PC

- 10BASE-T & 100BASE-TX
  - CAT5e UTP Cable
-



# 4

## **OPERATION AND FUNCTION**

OPERATING  
MANUAL

## 4 OPERATION and FUNCTION

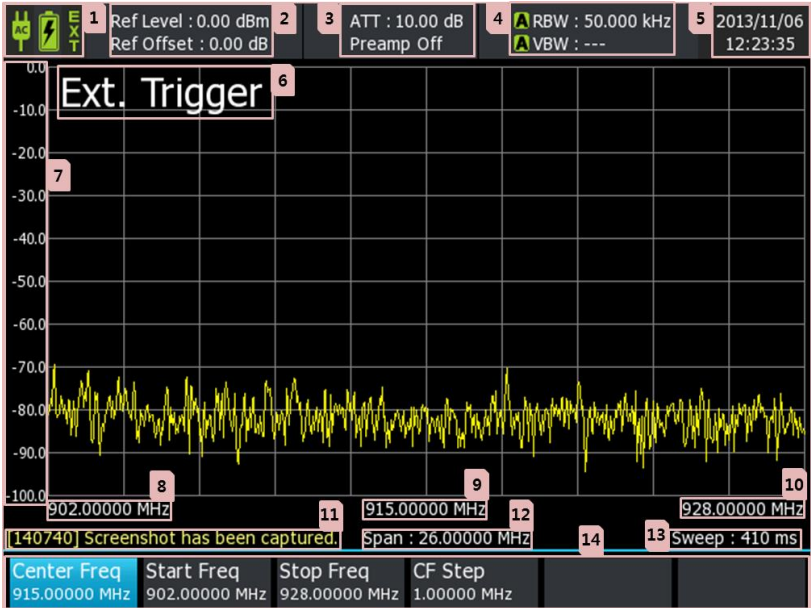











Figure 4-1 Main Window

Table 4-1 Main Window Descriptions

No.	Name	Category	Descriptions
1	AC Power	Icon	 - AC Power Adaptor connected
			 - AC Power Adaptor disconnected

	Battery Charge	&	Icon		- Battery connected to AC power - Battery full-charged
					- Operated with the battery - Remaining battery capacity is 90% or over
					- Operated with the battery - Remaining battery capacity is 8% or less
					- Battery is being charged - Remaining battery capacity is 90% or over
					- Battery is being charged - Remaining battery capacity is 8% or less
					- Battery has been removed
				EXT	External Interface
	- Sweep Type has been set to Continuous or Single, Internal Reference clock				
2	Ref Level	AMP		- Displays the top Line Amplitude value of the chart	
	Ref Offset	AMP		- Displays the Offset value of Ref. Level	
3	ATT	AMP		- Displays the Internal Attenuator setting - 4 setting values are available: 0 / 5 / 10 / 15	
	Preamp	AMP		- Displays Internal Amplifier On/Off	
4	RBW	BW/SWP		- Displays the Resolution Bandwidth value	

			<b>A</b>	- RBW Auto setting
			<b>M</b>	- RBW Manual setting
	VBW	BW/SWP		- Displays the Video Bandwidth value
			<b>A</b>	- VBW Auto setting
			<b>M</b>	- VBW Manual setting
5	Date & Time	SYS		- Displays the current date and time
6	Text	Status		- Ext. Trigger: Displays the external trigger status - Single: Displays the single sweep status - Pass/Fail: Displays Pass or Fail according to the Limit Line setting
7	Scale/Div	AMP		- Sets the scale of one grid of the vertical axis (Amplitude)
8	Start Freq.	Freq		- Displays the current Start Frequency
9	Center Freq.	Freq		- Displays the current Center Frequency
10	Stop Freq.	Freq		- Displays the current Stop Frequency
11	Short Message	Status		- Displays information according to operation and status
12	Span			- Displays the current Span
13	Sweep Time			- Displays the Sweep Time with the current conditions
14	Bottom Menu			- Displays the bottom menu of each function key - F1 ~ F6 key can be used - The display is changed according to the selected menu

## 4.1 Freq (Frequency)

The Freq (Frequency) control key allows you to change the frequency of the A734 for measurement. It is used to set the horizontal axis information of the screen and consists of Center Freq (F1), Start Freq (F2), Stop Freq (F3) and CF Step (F4). The Freq control key is located as shown in the following figure.



Figure 4-2 Frequency Control Key

Press the Freq key and then the F1 ~ F6 in the bottom menu will be changed as shown in the following figure and the Center Freq (F1) will be activated. The other menus, Start Freq (F2), Stop Freq (F3) and CF Step (F4), are disabled and the settings are changed according to the menu's activated/deactivated status. Therefore, press the number key for the activated menu and then an input window will be displayed. Press the Unit key at the bottom to complete input.



Figure 4-3 Frequency Menu-tree

Table 4-2 Frequency Menu Descriptions

Item	Select/Range	Description
Center Frequency(F1)	100kHz-4.4GHz	Enter the center frequency to set. Span is the same.
Start Frequency(F2)	100kHz-4.4GHz	Enter the Start Frequency to set. Span is changed according to the changed Start Frequency.
Stop Frequency(F3)	100kHz-4.4GHz	Enter the Stop Frequency to set. Span is changed according to the changed Stop Frequency.
CF Step(F4)	0Hz-4.3999GHz	Enter the CF Step to set.

**Notice**



The allowed range of center frequency, start frequency and stop frequency is from 100 kHz to 4.4 GHz, however, it can be limited according to Span or other settings.

You can view the current frequency in the main window. However, the sub menu of Freq provides the current frequency information at the bottom of each item. The allowed frequency range of A734 is from 100 kHz to 4.4 GHz and you should change the frequency within the given frequency.

## 4.1.1 Center Freq (F1)

The Center Freq (F1) changes the center frequency without changing the span to measure. When entering to the Freq menu, the Center Freq is activated by default. Press the number key and the frequency input window will appear. Enter the center frequency and then press the Unit key to start sweep with to the same span and the changed center frequency. The following figure shows that the activated Center Freq (F1) and the Center Frequency input window.

Key Stroke Sequence		Freq → Center Freq(F1)	
			
<b>Center Freq</b>	<b>Start Freq</b>	<b>Stop Freq</b>	<b>CF Step</b>
915.00000 MHz	902.00000 MHz	928.00000 MHz	1.00000 MHz

**Center Freq (F1) Activated**

- Press the Freq key and the Center Freq is activated by default. If any other menu is activated, you cannot change the setting. In this case, press the F1 key to activate the Center Freq and to enter the value.

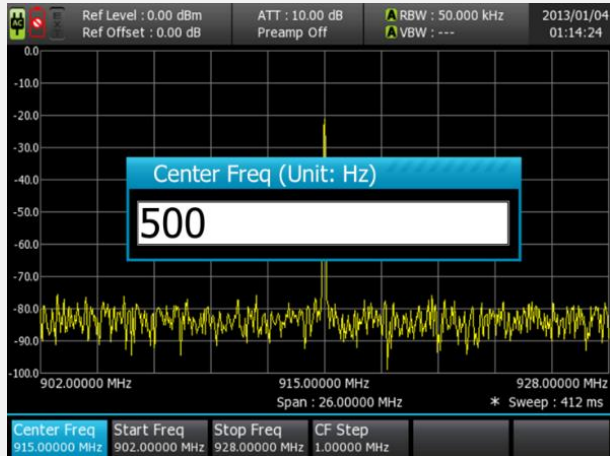

### Center Freq (F1) Input Window

- While the Center Freq is activated, press the number key to display the input window.
- Enter the center frequency value and then press the Unit key to complete the setting.
- If pressing 'Enter' after entering the value, not pressing the Unit key, the unit is in Hz.
- To close the window without saving the setting, press the ESC key.

To change the Center Frequency, you can use the Up/Down keys and the Rotary knob as follows.

### Changing the Center frequency with Numeric keys

Table 4-3 Changing Center Frequency (with Numeric Key)

1	<b>Activate</b>	Activate the Center Freq (F1).
2	<b>Open the</b>	While it is activated, press the number key to



	<b>frequency input window</b>	display the frequency input window. (Press the first number of the center frequency to change)
3	<b>Enter the center frequency value</b>	Enter the center frequency with the number keys.
4	<b>Unit key or Enter key</b>	'Enter' key → Sets the frequency in Hz as the center frequency. Unit key → Sets the center frequency with the entered frequency and the unit key.

The activated status is indicated as the item box in blue as shown in the following table.

**Table 4-4 Center Frequency Active & De-active**

Activated	Deactivated
Center Freq 915.00000 MHz	Center Freq 915.00000 MHz



**Changing the Center Frequency with the Up/Down keys or the rotary knob**



The Center Freq (F1) allows you to change the setting by using the Up/Down keys and the rotary knob while it is activated. Even when this function is activated, it does not work in Start Freq (F2), Stop Freq (F3) or CF Step (F4) but only in Center Freq (F1).



Figure 4-4 Center Frequency Control (Up/Down Key & Rotary)

Table 4-5 Changing Center Frequency (Up/Down Key & Rotary knob)

Item	Direction	Description
	Lower	The center frequency decreases as much as the CF Step (F4) setting value when the key is pressed once. 1 push → Changes the center frequency to the value of Center frequency-CF Step.
	Upper	The center frequency increases as much as the CF Step (F4) setting value when the key is pressed once.

		1 push → Changes the center frequency to the value of Center frequency+CF Step.
	Counterclockwise	The center frequency decreases as much as the frequency display resolution.
	Clockwise	The center frequency increases as much as the frequency display resolution.



### Notice

When you enter the frequency not supported by A734 or enter the start frequency higher than the stop frequency, a short message is displayed.

## 4.1.2 Start Freq (F2)

The Start Freq (F2) sets the start frequency of the bandwidth to measure and sets the start point on the left end of the vertical axis in the main window. When the Start Freq (F2) is changed, the span is changed as much as the changed start frequency, and the center frequency is also changed. Press the number key while the Start Freq (F2) is activated and the frequency input window will appear. Enter the start frequency and then press the Unit key to complete setting. The following figure shows that the activated Start Freq (F2) and the Start Frequency input window.

## Key Stroke Sequence

Freq → Start Freq(F2)

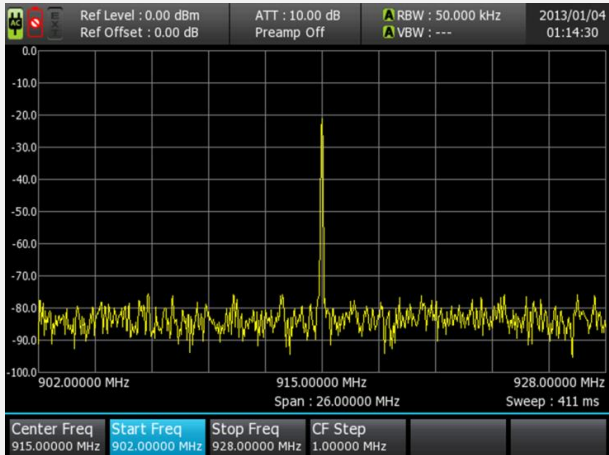

## Start Freq(F2) Activated

- Press the F2 key while the menu is the Freq menu.

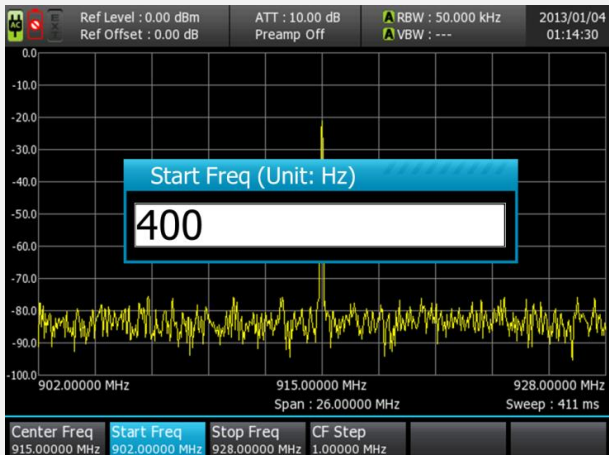

### Start Freq(F2) Input Window

- While Start Freq is activated, press the number key to display the input window.
- Enter the start frequency value and then press the Unit key to complete the setting.
- If pressing 'Enter' after entering the value, not pressing the Unit key, the unit is in Hz.
- To close the window without saving the setting, press the ESC key.

### Changing the Start frequency with Numeric keys

**Table 4-6 Changing Start frequency**

<b>1</b>	<b>Activate</b>	Activate the Start Freq(F2).
<b>2</b>	<b>Open the frequency input window</b>	While it is activated, press the number key to display the frequency input window. (Press the first number of the start frequency to change)
<b>3</b>	<b>Enter the start frequency value</b>	Enter the start frequency with the number keys.
<b>4</b>	<b>Unit key or Enter key</b>	'Enter' key → Sets the frequency in Hz as the start frequency. Unit key → Sets the start frequency with the entered frequency and the unit key.

The activated status is indicated as the item box in blue as shown in the following table.

Table 4-7 Start Frequency Active & De-active

Activated	Deactivated
	



**Notice**

The allowed range of start frequency is from 100 kHz to (Stop frequency+600 Hz). When you enter the frequency out of the range, a short message is displayed

### 4.1.3 Stop Freq (F3)

The Stop Freq (F3) sets the stop frequency of the sweep data to measure and sets the start point on the right end of the vertical axis in the main window. When the Stop Freq (F3) is changed, the span is changed as much as the changed stop frequency, and the center frequency is also changed. Press the number key while the Stop Freq (F3) is activated and the frequency input window will appear. Enter the stop frequency and then press the Unit key to complete setting. The following figure shows that the activated Stop Freq (F3) and the Stop Frequency input window.

## Key Stroke Sequence

Freq → Stop Freq(F3)

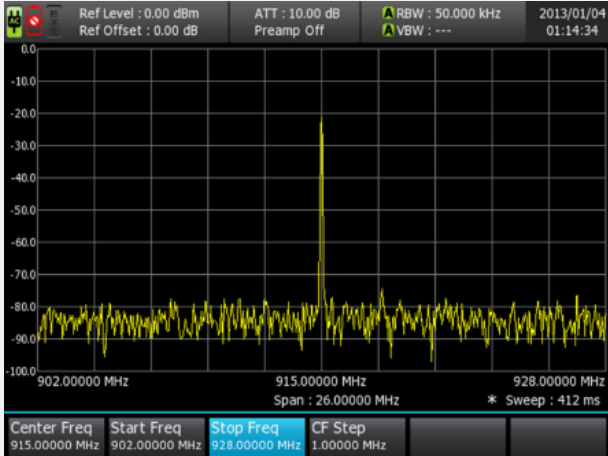

## Stop Freq (F3) Activated

- Press the F3 key while the menu is the Freq menu.

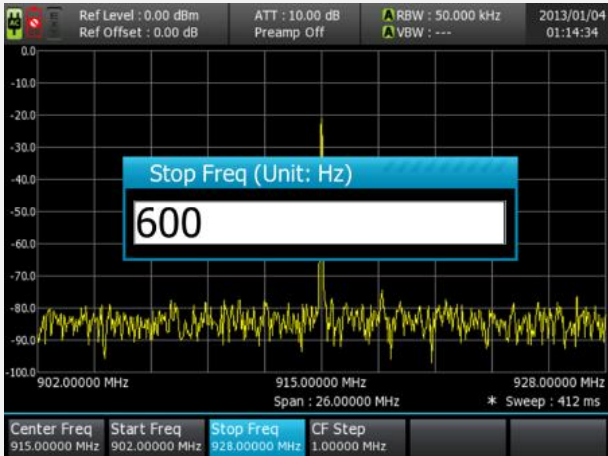

### Stop Freq (F3) Input Window

- While Stop Freq is activated, press the number key to display the input window.
- Enter the stop frequency value and then press the Unit key to complete the setting.
- If pressing 'Enter' after entering the value, not pressing the Unit key, the unit is in Hz.
- To close the window without saving the setting, press the ESC key.

### Changing the Stop frequency with Numeric keys



**Table 4-8 Changing Stop Frequency**

1	<b>Activate</b>	Activate the Stop Freq (F3).
2	<b>Open the frequency input window</b>	While it is activated, press the number key to display the frequency input window. (Press the first number of the start frequency to change)
3	<b>Enter the start frequency value</b>	Enter the stop frequency with the number keys.
4	<b>Unit key or Enter key</b>	'Enter' key → Sets the frequency in Hz as the stop frequency. Unit key → Sets the stop frequency with the entered frequency and the unit key.

The activated status is indicated as the item box in blue as shown in the following table.

**Table 4-9 Stop Frequency Active & De-active**

Activated	Deactivated
	



**Notice**

The allowed range of Stop frequency is from 100 kHz to (Start frequency+600 Hz). When you enter the frequency out of the range, a short message is displayed

## 4.1.4 CF Step (F4)

The CF Step (F4) is the only one item of which frequency is not affected by the changed setting. The CF Step (F4) sets the changing width of the center frequency per one pressing of the Up/Down key to adjust the center frequency. The center frequency is changed only when the Up/down key is pressed after activating the Center Freq (F1). The following figure shows that the activated CF Step (F4) and the CF Step input window.

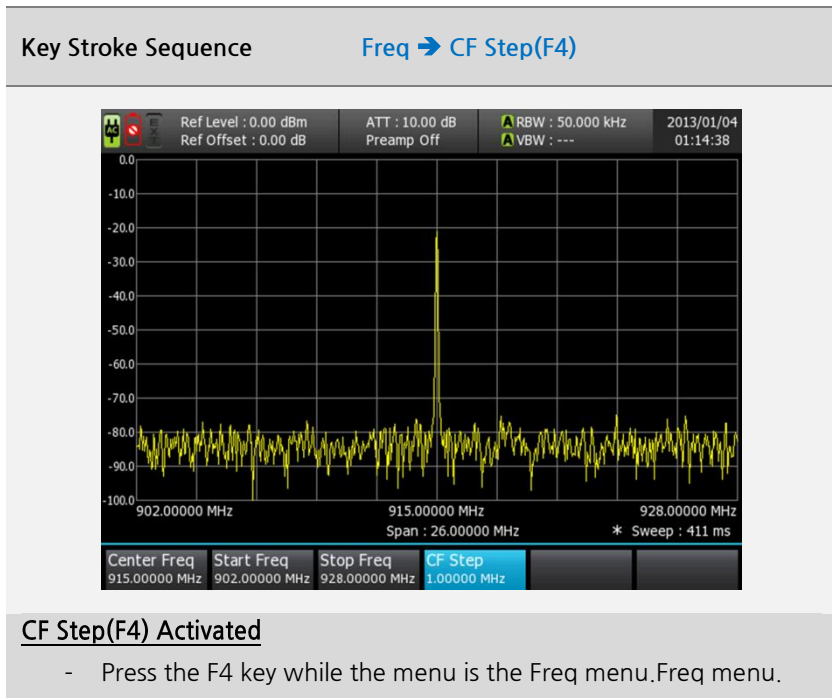



### CF Step(F4) Input Window

- While CF Step is activated, press the number key to display the input window.
- Enter the CF Step value and then press the Unit key to complete the setting.
- If pressing 'Enter' after entering the value, not pressing the Unit key, the unit is in Hz.
- To close the window without saving the setting, press the ESC key.

### Changing the CF step with Numeric keys



Table 4-10 Changing CF Step

1	<b>Activate</b>	Activate the CF Step (F4).
2	<b>Open the frequency input window</b>	While it is activated, press the number key to display the frequency input window. (Press the first number of the CF Step to change)

3	<b>Enter the CF Step value</b>	Enter the CF Step with the number keys.
4	<b>Unit key or Enter key</b>	'Enter' key → Sets the frequency in Hz as the CF Step. Unit key → Sets the CF Step with the entered frequency and the unit key.

The activated status is indicated as the item box in blue as shown in the following table.

**Table 4-11 CF Step Active & De-active**

Activated	Deactivated
	



**Notice**

The allowed range of CF Step is from 0 Hz to 4.3999 GHz. When you enter the frequency out of this range, a short message indicating the range error is displayed. When changing the center frequency after setting the CF Step, if you enter the frequency out of the range supported by A734, a short message indicating the range error is displayed.

## 4.2 Span

Span is the sweep frequency range (Stop frequency ~ Start frequency), indicating the frequency range displayed on the screen. Therefore, when the span is changed, the sweep frequency range is changed, too. When the Span is changed, the current center frequency is fixed but the start frequency and the stop frequency are changed. The sub menus of Span are Set Span (F1), Full Span (F2) and Zero Span (F3) and the Span key is located as shown in the following figure.



Figure 4-5 Span Control Key

Press the Span key and then the F1 ~ F6 in the bottom menu will be changed to the sub menus of Span and the Set Span (F1) will be activated. The other menus, Full Span (F2) and Zero Span (F3), are disabled. For the

Full Span (F2), when it is executed, the Set Span (F1) is activated. Therefore, the Full Span (F2) has no activated status. When the Set Span (F1) is activated, press the number key to change the span. When the Zero Span (F3) is activated, the time information of the Zero Span can be set.



Figure 4-6 Span Menu-tree

Table 4-12 Span Menu Descriptions

Item	Description
Set Span(F1)	Enter the span frequency to set. The Center Frequency is fixed.
Full Span(F2)	Set the Full Span. Full Span Range: 200 MHz ~ 4.4 GHz
Zero Span(F3)	Set the Zero Span. X-axis: changed to the time domain. Set the sweep time while the Zero Span is activated. Range: 10 ~ 2000 ms

You can view the current span information in the main window. However, the sub menu of Span provides the current information at the bottom of each item. The allowed span range of A734 is from 0 Hz to 4.3999 GHz and you should change the span within the given frequency.

## 4.2.1 Set Span (F1)

The Set Span (F1) changes the current span. The Set Span (F1) changes the start frequency and the stop frequency based on the current center frequency. When entering to the Span menu, the Set Span (F1) is activated by default. Press the number key and the frequency input window will appear. Enter the span value and then press the Unit key to change the span. The following figure shows that the activated Set Span (F1) and the Set Span input window.

Key Stroke Sequence      [Span](#) → [Set Span\(F1\)](#)

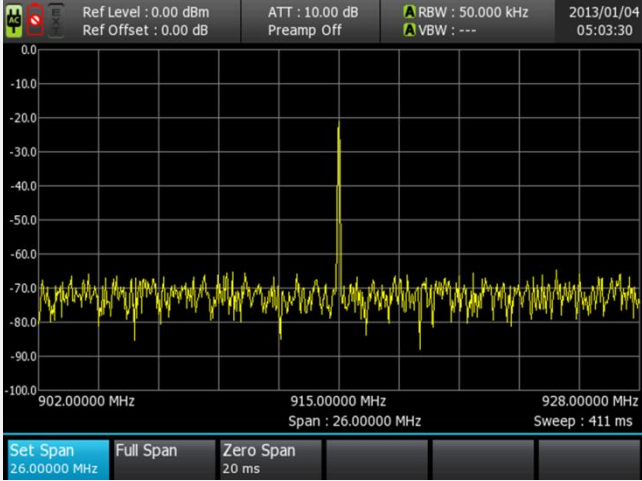

The screenshot displays a spectrum analyzer interface. At the top, there are several status indicators: 'Ref Level : 0.00 dBm', 'Ref Offset : 0.00 dB', 'ATT : 10.00 dB', 'Preamp Off', 'RBW : 50.000 kHz', 'VBW : ---', and the date/time '2013/01/04 05:03:30'. The main display area shows a signal trace with a prominent peak at 915.00000 MHz. The frequency axis ranges from 902.00000 MHz to 928.00000 MHz, with a span of 26.00000 MHz. The amplitude axis ranges from 0.0 to -100.0 dBm. At the bottom, there is a menu with several options: 'Set Span' (highlighted in blue, showing '26.00000 MHz'), 'Full Span', 'Zero Span' (showing '20 ms'), and two empty slots.

### Set Span (F1) Activated

- Press the Span key and then the menu is activated by default.
- When the Zero Span is activated, you cannot change the setting. In this case, press the F1 key to activate the menu and to change the setting.

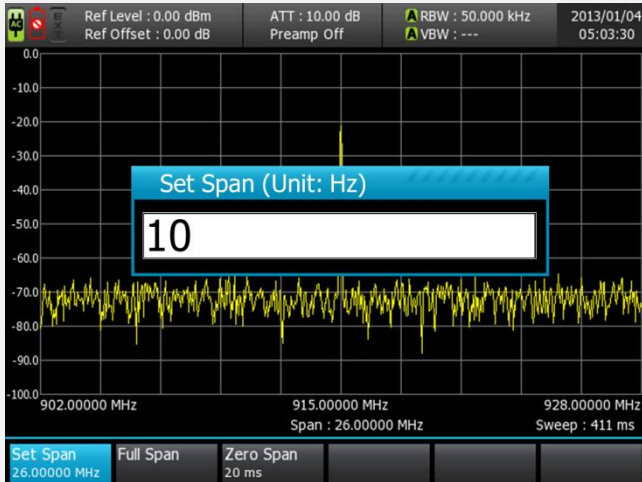

### Set Span (F1) Input Window

- While Set Span is activated, press the number key to display the input window.
- Enter the span value and then press the Unit key to complete the setting.
- If pressing 'Enter' after entering the value, not pressing the Unit key, the unit is in Hz.
- To close the window without saving the setting, press the ESC key.

To change the span, you can use the Up/Down keys and the Rotary knob as follows.

### Changing the Set Span with Numeric keys



**Table 4-13 Changing Set Span (with number keys)**

1	<b>Activate</b>	Activate the Set Span (F1).
2	<b>Open the frequency input window</b>	While it is activated, press the number key to display the frequency input window. (Press the first number of the span to change)
3	<b>Enter the span value</b>	Enter the span with the number keys.
4	<b>Unit key or Enter key</b>	'Enter' key → Sets the frequency in Hz as the span. Unit key → Sets the span with the entered frequency and the unit key.

The activated status is indicated as the item box in blue as shown in the following table.

**Table 4-14 Set Span Active & De-active**

Activated	Deactivated
	

**Changing the Set Span with the Up/Down keys or the rotary knob**

You can change the setting by using the Up/Down keys and the rotary knob while Set Span (F1) is activated. Even when this function is activated, it does not work in Zero Span (F3) but only in Set Span (F1).



**Figure 4-7 Span Control (Up/Down Key & Rotary)**

While the Set Span (F1) is activated, press the Up/Down keys and then the span will be changed in the 1-2-5 sequence. The 1-2-5 sequence indicates that the span is changed to the value which starts with 1, 2 or 5 and is lower or higher than the current span value. For example, when the current span is 100 MHz, press  $\nabla$  and then the span is changed to 50 MHz. At this time, press  $\nabla$  again and then the span is changed to 20 MHz. In reverse, when the current span is 100 MHz, press  $\triangle$  and then it is changed to 200 MHz. At this time, press  $\triangle$  again and then the span is changed to 500 MHz.

[Up(^) key operation]

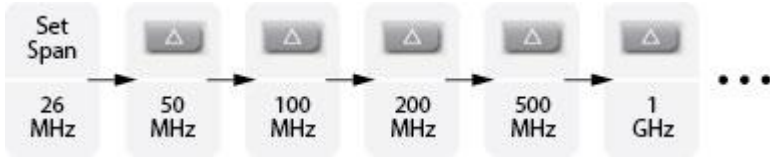



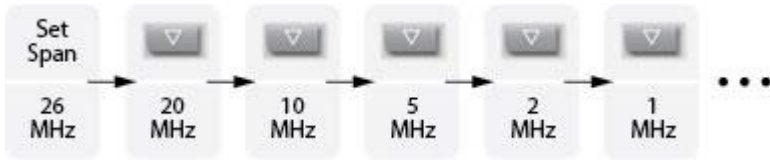

[Down(v) key operation]



The following table shows the change of Set Span(F1) with the Up/Down keys and the rotary knob.

**Table 4-15 Changing Span (Up/Down Key & Rotary knob)**

Item	DitECTION	Description
	Lower	1 push -> decreased the span in 1-2-5 sequence.
	Upper	1 push -> increased the span in 1-2-5 sequence.
	Counterclockwise	Decreases span with a small value.
	Clockwise	Increases span with a small value.



### Notice

When you enter the span value not supported by A734, a short message is displayed.

## 4.2.2 Full Span (F2)

The Full Span (F2) changes the span to the current full span. Pressing the Full Span (F1) key changes the span within the range from 200 MHz to 4.4 GHz. After applying the Full Span, the Set Span (F1) is activated. You can change to other span value by following the procedure described in 4.2.1. The following figure shows the result of executing Full Span (F2).

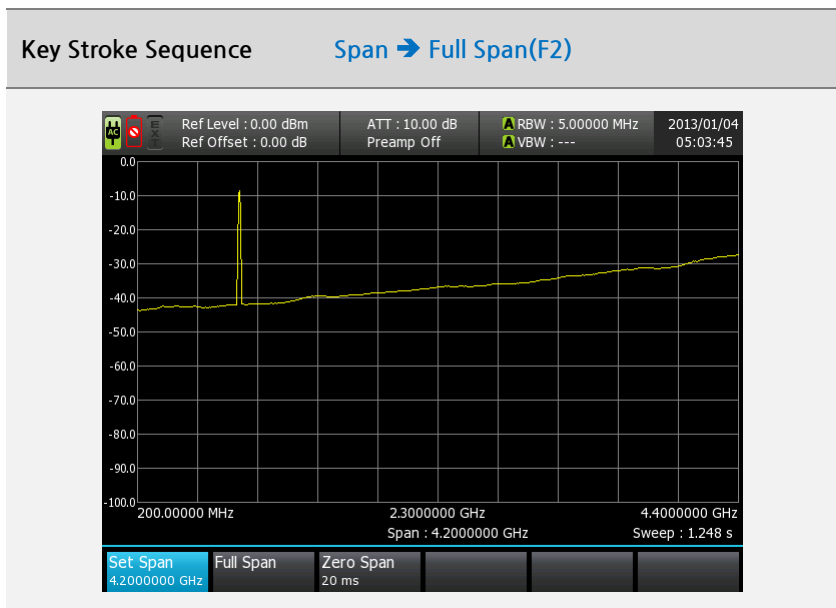

### Full Span(F2) Execution

- Set the span to 200MHz ~ 4.4GHz (center frequency: 2.3GHz)
- After applying the Full Span, the Set Span(F1) is activated as shown above.



#### **Notice**

The range of Full Span of A734 should be specified to the value from 200 MHz to 4.4 GHz because of the sweep speed. If the frequency under 162 MHz should be swept, the RBW cannot be set to 5 MHz but to 250 kHz. At this time, when the Full Span is set to the value lower than 162 MHz, it takes too much time to process the full span with the 250 kHz RBW.

Therefore, the range of Full Span of A734 has been set to 200 MHz ~ 4.4 GHz. To measure the low frequency section, it is recommended to set the span for only the low section for efficient measurement.

### 4.2.3 Zero Span (F3)

The Zero Span (F3) is to measure the change of frequency with 0 Hz span. Set the desired point as the center frequency and then execute Zero Span. The span is set to 0 Hz and the horizontal axis is changed to the Time axis. The length of the Time can be set within the range of 10 ~ 2000 ms and the default value is 20 ms.

Key Stroke Sequence

Span → Zero Span(F3)

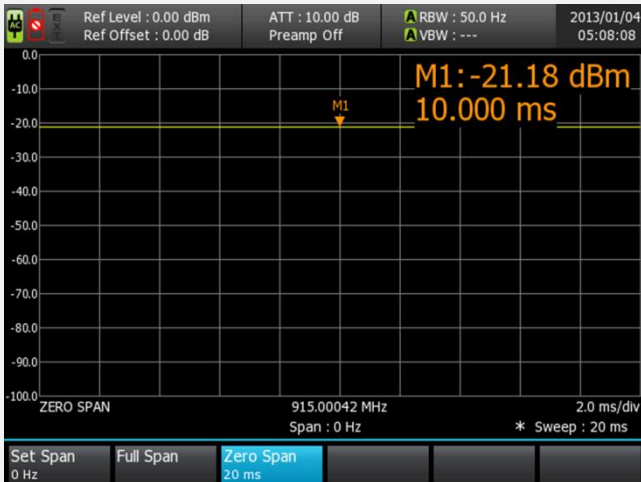

#### Zero Span(F3) Setting

- When setting the Zero Span, the x-axis is the Time axis. Therefore, the Trace shows the time-based result. When the marker is set, the time information is displayed on the x-axis.

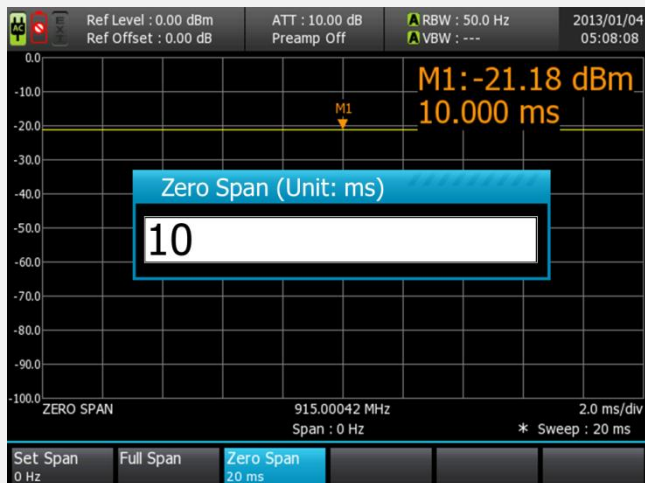

### Zero Span(F3) Time Setting

- While Zero Span is activated, press the number key to display the input window.
- Enter the time value and then press the 'Enter' key to complete the setting.
- To close the window without saving the setting, press the ESC key.



#### **Notice**

When the Zero Span is set, narrow the span as much as possible to reduce the frequency error, increasing the accuracy.

To change the time at the Zero Span, you can use the number keys as follows.

### Changing the Zero Span by using number keys

**Table 4-16 Chancing Zero Span (number keys)**

1	Execute and activate Zero span	Execute Zero Span (F3) (it should be activated)
2	Open the Time input window	While it is activated, press the number key to display the time input window. (Press the first number of the time to change)
3	Enter the time value	Enter the time with the number keys.
4	Press the Enter key	'Enter' key → Sets the sweep time in ms.



**Notice**

In the Zero Span, the time range is from 10 to 2000 ms. As the unit in the input window is ms, the time unit should be ms.

The activated status is indicated as the item box in blue as shown in the following table.

**Table 4-17 Zero Span Active & De-active**

Activated	Deactivated
<b>Zero Span</b> 20 ms	<b>Zero Span</b> 20 ms



### 4.3 Amp (Amplitude)

The Amp (Amplitude) allows you to change the Amplitude-related items of A734, the Y-axis on the screen. The Amp menu consists of Ref Level(F1), Scale/Div(F2), Unit(F3), Atten(F4), Preamp(F5) and Ref Offset(F6). The Amp key is located as shown in the following figure.



Figure 4-8 Amplitude Control Key

Pressing the Amp key changes the bottom menu F1 ~ F6 to the Amplitude items and the Ref Level(F1) is activated. Only when the menu is activated, the value can be changed. To activate the deactivated menu, click the corresponding F key. When the menu is activated, set the value by using the number keys or press the F key like On/Off to change the setting.



Figure 4-9 Amplitude Menu-tree

Table 4-18 Amplitude Menu Descriptions

Item	Select/Range	Description
Ref Level(F1)	+20dBm to -80dBm	Sets the top value of the Y-axis
Scale/Div(F2)	0.2, 0.5, 1, 2, 5, 10dB	Sets the width of the one grid of Y-axis
Unit(F3)	dBm	Displays the Amplitude in dBm scale
	Watts	Displays the Amplitude in Watts scale
Atten(F4)	0, 5, 10, 15dB	Changes the internal attenuator setting
Preamp(F5)	On	Set Preamp On
	Off	Set Preamp Off
Ref Offset(F6)	+300dB to -300dB	Compensates the measurement result as much as the specified Ref Offset

You can view the current amplitude information in the main window. However, the sub menu of Amp provides the current information at the bottom of each item. The maximum amplitude range of A734 is +20 dBm. To measure the signal larger than +20 dBm, you should connect an attenuator additionally.

### 4.3.1 Ref Level(F1)

The Ref Level(F1) sets the top value of the Y-axis on the screen. If the input signal is larger than the specified Ref Level, the trace shown on the screen cannot show the top value. Therefore, you need to set the Ref Level larger than the input signal. When entering to the Amp menu, the Ref Level(F1) is activated by default. Pressing the number keys displays the Ref Level input window. Enter the Ref Level value and then press the Enter key to complete setting and to update the Y-axis information. The following figure shows that the activated Start Freq (F2) and the Start Frequency input window.

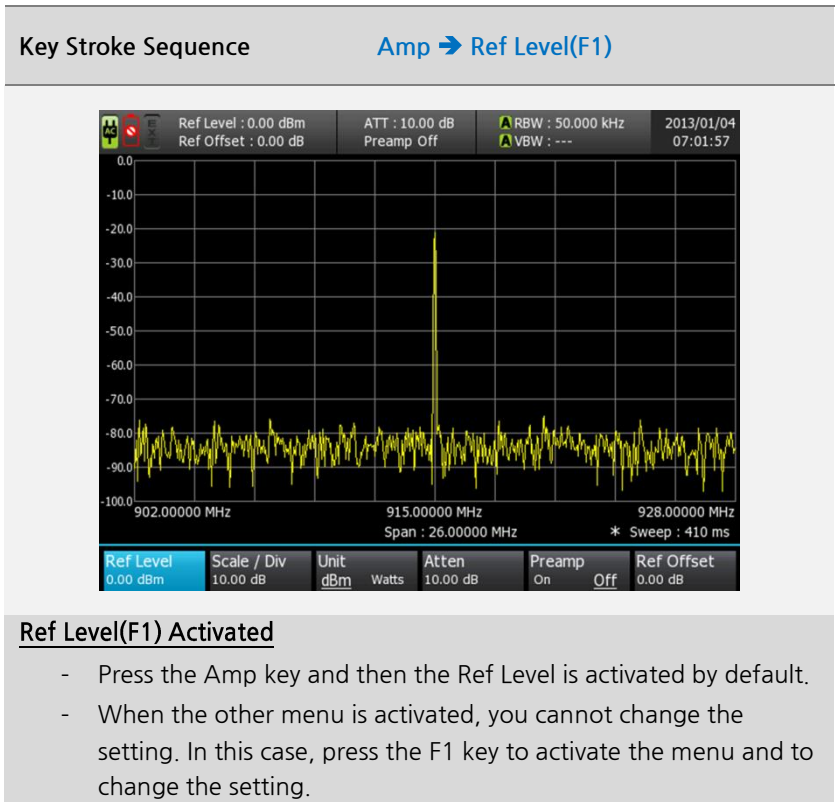

#### Ref Level(F1) Activated

- Press the Amp key and then the Ref Level is activated by default.
- When the other menu is activated, you cannot change the setting. In this case, press the F1 key to activate the menu and to change the setting.

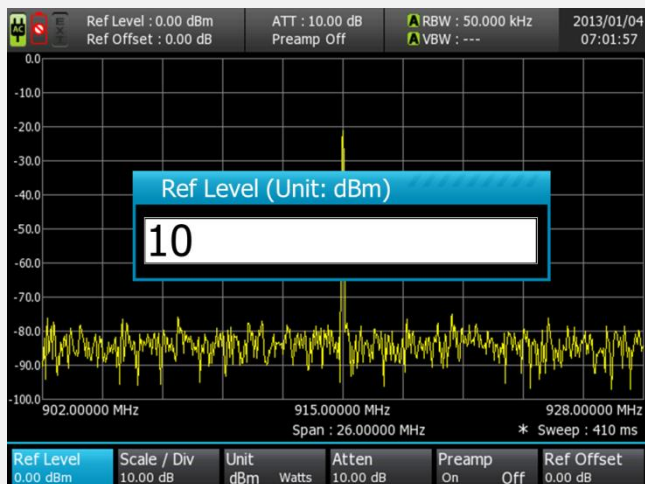

### Ref Level(F1) Input Window

- While Ref Level is activated, press the number key to display the input window.
- Enter the reference level value and then press the 'Enter' key to complete the setting.
- If pressing 'Enter' after entering the value, not pressing the Unit key, the unit is in Hz.
- To close the window without saving the setting, press the ESC key.

To change the Reference level, you can use the Up/Down keys and the Rotary knob as follows.



### Changing the Ref Level by using number keys

**Table 4-19 Changing Ref Level (number keys)**

1	<b>Activate</b>	Activate the Ref Level(F1).
2	<b>Open the Ref Level input window</b>	While it is activated, press the number key to display the Ref Level input window. (Press the first number of the Ref Level to change)
3	<b>Enter the Ref Level value</b>	Enter the Ref Level with the number keys.
4	<b>Enter key</b>	'Enter' key → Sets the Ref Level to the entered value.

The activated status is indicated as the item box in blue as shown in the following table.

**Table 4-20 Ref Level Active & De-active**

Activated	Deactivated
	

**Changing the Ref Level with the Up/Down keys or the rotary knob**

The Ref Level(F1) allows you to change the setting by using the Up/Down keys and the rotary knob while it is activated. When Center Freq(F1) is activated, press ▽ or rotate the rotary knob to counterclockwise to decrease the Ref level. press △ or rotate the rotary knob to clockwise to increase the Ref level.



Figure 4-10 Reference Level Control (Up/Down Key & Rotary)

Table 4-21 Changing Ref Level (Up/Down Key & Rotary knob)

Item	Ditection	Description
	Lower	<p>The Ref Level decreases as much as the Scale/Div(F2) setting value when the key is pressed once.</p> <p>1 push → Changes the Ref Level to the value of Ref Level - Scale/Div.</p>



Upper

The Ref Level increases as much as the  $\text{Scale/Div}(F2)$  setting value when the key is pressed once.  
1 push → Changes the Ref Level to the value of Ref Level + Scale/Div.

---



Counterclockwise

The Ref Level decreases as much as the  $\text{Scale/Div}(F2)/10$  when the key is pressed once.

---



Clockwise

The Ref Level increases as much as the  $\text{Scale/Div}(F2)/10$  when the key is pressed once.

---



### Notice

The mixers can typically operate with up to +0 dBm input, but keeping the input level -25 dBm or lower will greatly improve linearity.

## 4.3.2 Scale/Div(F2)

The Scale/Div(F2) adjusts the width of the one grid on the Y-axis. To control this, it should be activated. When it is activated as shown below, it can be set by using the Up/Down keys or the rotary knob. The Scale/Div(F2) does not allow you to enter the value with number keys.

### Key Stroke Sequence

Amp → Scale/Div(F2)

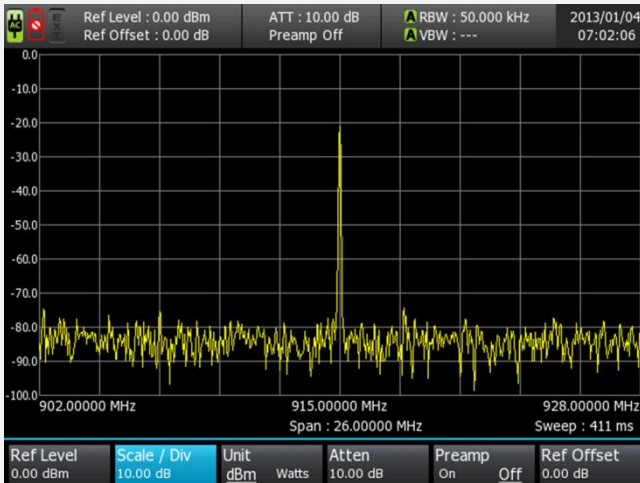

### Scale/Div(F2) Activated

- The default value is 10.00 dB.
- Change the setting by using the Up/Down keys or the rotary knob.

The Scale/Div(F2) allows you to set the determined value in sequence by pressing the Up/Down keys or by rotating the rotary knob. The determined Scale/Div values are 0.2dB, 0.5dB, 1.0dB, 2.0dB, 5.0dB and 10.0dB. The value is changed whenever pressing the Up/Down keys once or rotating the rotary knob by one click. For example, as shown in the following table, when the current value is 10.0 dB, press  $\nabla$  and then the Scale/Div is changed to 5.0 dB. At this time, press  $\nabla$  again and then the value is



changed to 2.0 dB. In reverse, when the current value is 5.0 dB, press  $\Delta$  and then it is changed to 10.0 dB.

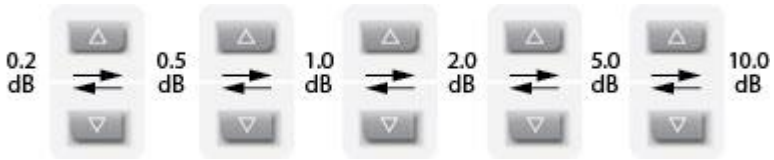

### Notice



Like the Up/Down keys, when rotating the rotary knob to the clockwise, the value is changed to the value higher than the current value. In reverse, when rotating the rotary knob to the counterclockwise, the value is changed to the value lower than the current value.

### 4.3.3 Unit(F3)

By default, the amplitude unit is dBm scale. However, for some users' convenience, Watts scale is provided in a limited range. As shown in the following figure, all amplitude items of A734 are in dBm scale. When Watts scale is applied, only the amplitude information of the marker, channel power and the power level of the ACP are displayed in Watts scale. To change (toggle) the setting, press Unit(F3).

## Key Stroke Sequence **Amp** → **Unit(F3)**

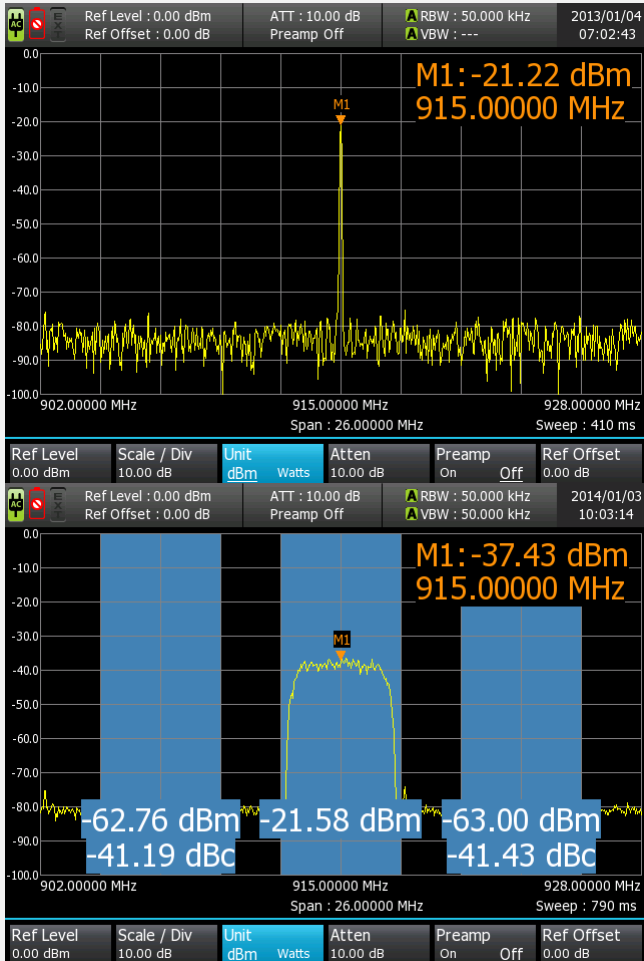

### Unit(F3) dBm Setting

- Unit of all Amplitude values are dBm by default.

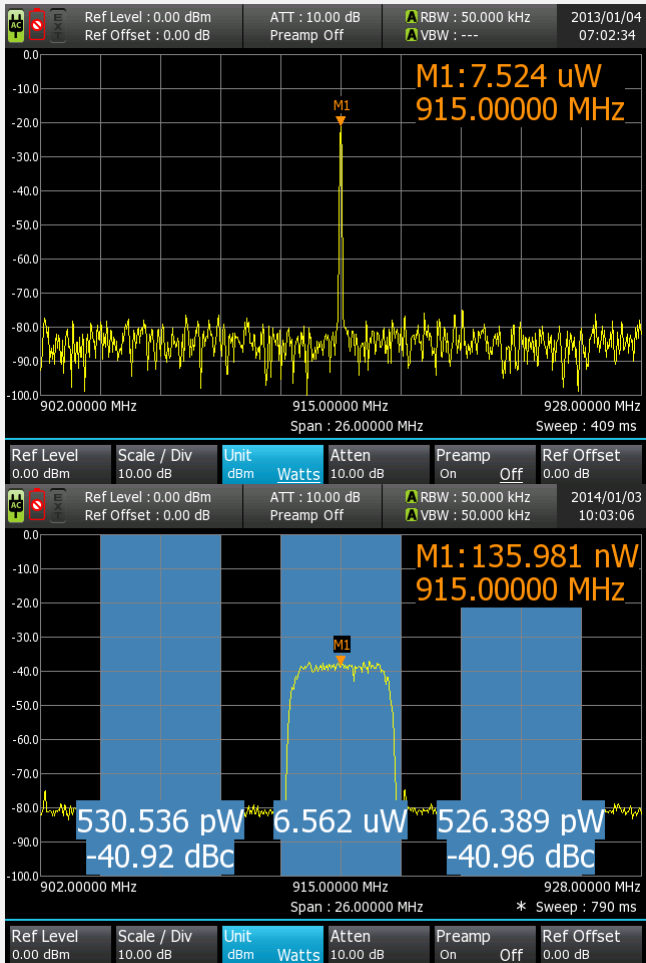

### Unit(F3) Watts Setting

- When changed to the Watts scale, only the amplitude information of the marker and channel power is changed to Watts scale.

## 4.3.4 Atten(F4)

The Atten(F4) adjusts the internal attenuator size. To control this, it should be activated. When it is activated as shown below, it can be set by using the Up/Down keys or the rotary knob. The Atten(F4) does not allow you to enter the value with number keys.

**Key Stroke Sequence**      **Amp → Atten(F4)**

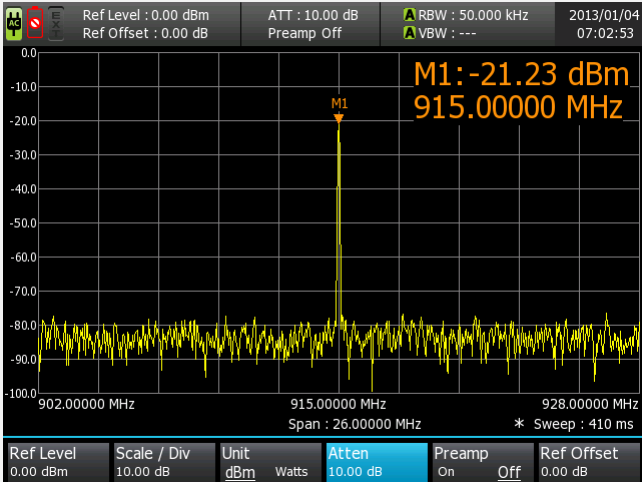

The screenshot displays a spectrum analyzer interface. At the top, there are several status indicators: a signal strength icon, a noise floor icon, and a date/time stamp (2013/01/04 07:02:53). Below these, there are two rows of settings: 'Ref Level : 0.00 dBm' and 'Ref Offset : 0.00 dB' on the left; 'ATT : 10.00 dB' and 'Preamp Off' in the center; and 'RBW : 50.000 kHz' and 'VBW : ---' on the right. The main display area shows a frequency spectrum with a prominent peak labeled 'M1' at 915.00000 MHz, with a level of -21.23 dBm. The y-axis represents power in dBm, ranging from 0.0 to -100.0. The x-axis represents frequency in MHz, ranging from 902.00000 to 928.00000. The span is 26.00000 MHz and the sweep time is 410 ms. At the bottom, there is a control bar with several buttons: 'Ref Level' (0.00 dBm), 'Scale / Div' (10.00 dB), 'Unit' (dBm, Watts), 'Atten' (10.00 dB), 'Preamp' (On, Off), and 'Ref Offset' (0.00 dB). The 'Atten' button is highlighted in blue.

**Atten(F4) Activated**

- The default value is 10.00 dB.
- Change the setting by using the Up/Down keys or the rotary knob.

The Atten(F4) allows you to set the determined value in sequence by pressing the Up/Down keys or by rotating the rotary knob. The determined internal attenuator values are 0.0dB, 5.0dB, 10.0dB and 15.0dB. The value is changed whenever pressing the Up/Down keys once or rotating the rotary knob by one click. For example, as shown in the following table, when the current value is 10.0 dB (the default value), press  $\nabla$  and then the Atten(F4) is changed to 5.0 dB. At this time, press  $\nabla$  again and then

the value is changed to 0.0 dB. In reverse, when the current value is 5.0 dB, press  $\Delta$  and then it is changed to 10.0 dB.

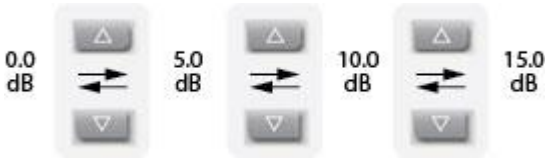

Like the Up/Down keys, when rotating the rotary knob to the clockwise, the value is changed to the value higher than the current value. In reverse, when rotating the rotary knob to the counterclockwise, the value is changed to the value lower than the current value.



#### Notice

When measuring the input signal with low level, set the internal attenuator to 0 dB to improve the measurement accuracy.



#### Notice

A Local Oscillator signal may be observed at the RF input port, often found 10.7 MHz above the RF frequency being scanned. Typically, this level will not interfere with your measurements. If you are connecting to an antenna, please use the preamplifier and set the attenuator to 15 dB to minimize LO leakage. This will typically reduce your LO leakage to less than 2 nanowatts for all frequencies below 1 GHz.



#### Notice

The Atten(F4) setting value is limited by the Ref.Level setting. For example, in the following section, the setting value is limited. If you try to set the value out of the limit, the following notice popup appears.

0dBm < Ref.Level ≤ 10dBm → Sets Atten ≥ 10dB  
 10dBm < Ref.Level → Sets Atten=15dBm



### 4.3.5 Preamp(F5)

The Preamp(F5) turns on or off the RF Preamplifier in A734. If the input signal is low, set the Preamp(F5) to On to increase the internal gain in the A734 for improved measurement sensitivity. If the input signal is high, set the Preamp(F5) to Off. To toggle the setting between On and Off, press the Preamp(F5).

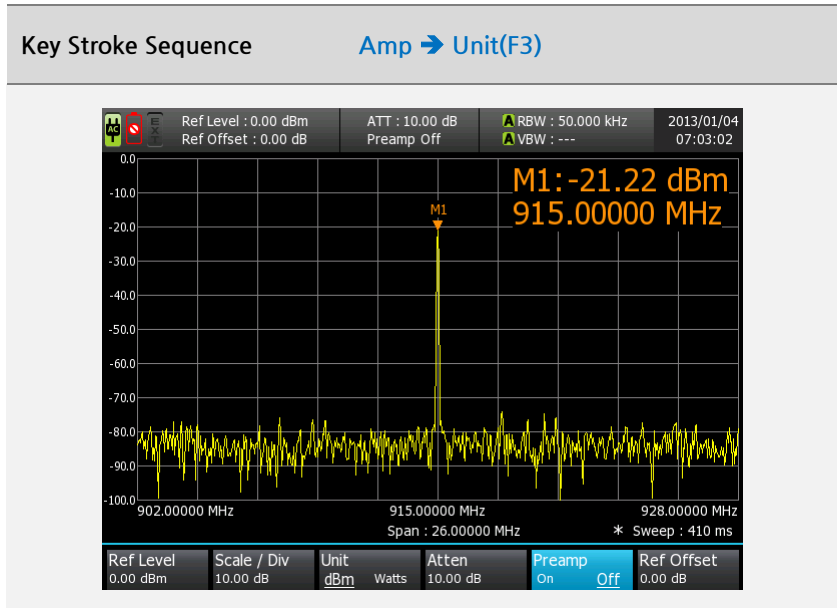

### Preamp(F5) Off Setting

- The default setting: Off
- Set when the input signal is high.

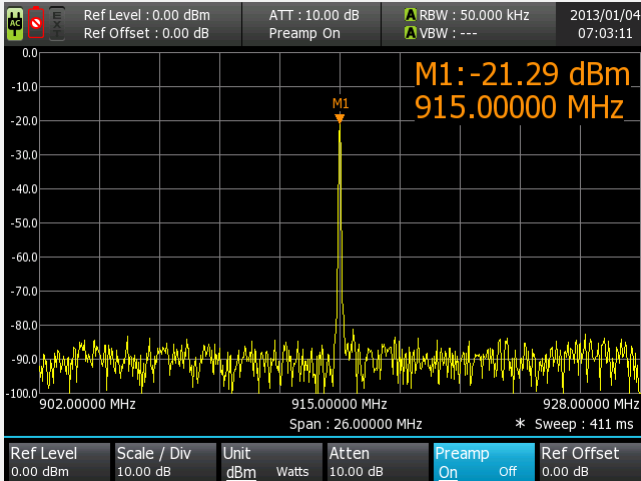

### Preamp(F5) On Setting

- Set when the input signal is low.
- Increase sensitivity and reduce LO feed-thru
- Set to On when the max. input signal is -20 dBm or lower.

#### **Notice**

A Local Oscillator signal may be observed at the RF input port, often found 10.7 MHz above the RF frequency being scanned. Typically, this level will not interfere with your measurements. If you are connecting to an antenna, please use the preamplifier and set the attenuator to 15 dB to minimize LO leakage. This will typically reduce your LO leakage to less than 2 nanowatts for all frequencies below 1 GHz.



## 4.3.6 Ref Offset(F6)

The Ref Offset(F6) sets the offset of the Y-axis on the screen. You can set it when the value should be compensated because of extension cable loss or connection of an external attenuator. When the Ref. Offset is set to the amplitude offset, the Y-axis is the value of Ref Level + Ref Offset and the offset is applied to the measured trace size, too. After activating the Ref Offset, press the number key and then the Ref Offset input window will appear. Enter the Ref Offset value and then click the Enter key to complete setting and to update the Y-axis information. The following figure shows that the activated Ref Offset(F6), the Ref Offset(F6) input window and the Ref Offset(F6) setting.

Key Stroke Sequence

Amp → Ref Offset(F6)

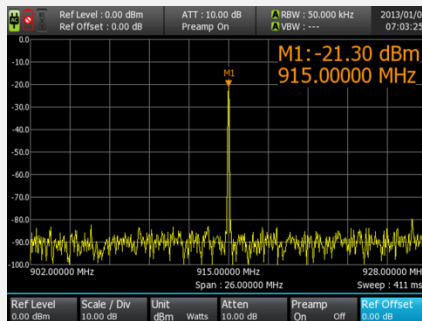

### Ref Offset(F6) Activated

- Activate the Ref Offset as shown in the figure to apply it.



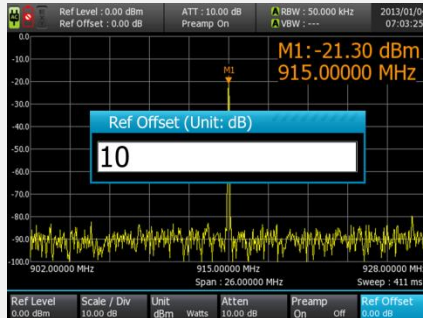

### Ref Offset(F6) Input Window

- While Ref Offset is activated, press the number key to display the input window.
- Enter the Ref Offset value and then press the 'Enter' key to complete the setting.
- To close the window without saving the setting, press the ESC key.

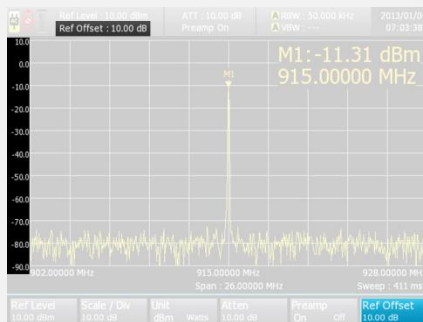

### Ref Offset(F6) Setting

- The above figure shows that the Ref.Offset has been set to 10 dB.
- As shown in the figure, 10dB is displayed in the Ref Offset and the Y-axis is increased as much as the Ref.Offset setting value.

To change the reference offset, you can use the number keys. Up/Down keys and the rotary knob are not supported by the Ref Offset(F6).

**Changing Ref Offset by using number keys**

**Table 4-22 Changing Ref Offset (number keys)**

1	<b>Activate</b>	Activate the Ref Offset(F6).
2	<b>Open the Ref Offset input window</b>	While it is activated, press the number key to display the Ref Offset input window. (Press the first number of the Ref Offset to change)
3	<b>Enter the Ref Offset value</b>	Enter the Ref Offset with the number keys.
4	<b>Enter key</b>	'Enter' key → Sets the Ref Offset to the entered value.

The activated status is indicated as the item box in blue as shown in the following table.

**Table 4-23 Ref Offset Active & De-active**

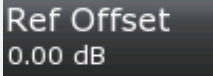
Activated	Deactivated
	



**Notice**

The allowed range of Ref Offset is from -300 dB to +300 dB.

## 4.4 BW/SWP (Bandwidth/Sweep)

The BW/SWP menu provides functions to set RBW/VBW, Detector mode, Sweep Type, Sweep Time and Ref. Clock. As shown below, click the BW/SWP key to change the F1 ~ F6 keys to BW/SWP functions.



Figure 4-11 Bandwidth & Sweep Control Key

Pressing the BW/SWP key changes the F1 ~ F6 keys BW/SWP functions as shown in the following figure. For RBW(F1), VBW(F2) and Ref Clock(F6), the setting is toggled by pressing the key. For SWP Type(F3), SWP Time(F4) and Detector(F5), pressing the key to change F1 ~ F6 keys to each sub layer.

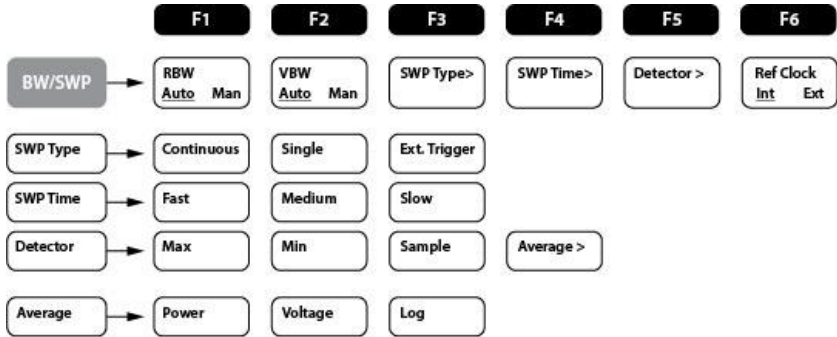

Figure 4-12 BW/SWP Menu-tree

Table 4-24 BW/SWP Menu Descriptions

Item	Select	Description
RBW(F1)	Auto	Automatically sets the RBW to the value saved internally as the span is changed.
	Manual	Sets the available value among the RBW list according to the span.
VBW(F2)	Auto	Automatically sets the VBW to the value saved internally as the span is changed.
	Manual	Sets the available value among the VBW list according to the span.
Sweep Type(F3)		Sets the sweep type to Single, Continuous or Ext Trigger.
Sweep Time(F4)		Adjusts the amount of collected data by trace and displays the measurement result.
		Can be operated when the RBW and the VBW are 3.2 kHz or less.
Detector(F5)		Sets the Data Detector type. Choose one from Max, Min, Sample and Average (Power, Voltage, Log).
Ref Clock(F6)		Sets whether to use the Int. clock or the

The BW/SWP can control the filter configuration from the IF filter to the video filter in a general spectrum structure. The IF filter of A734 is implemented as the FFT type and the IF filter is called the RBW. The RBW is an index which can determine the frequency resolution; when the smaller value is set, the frequency resolution is higher. However, it takes much time to process data because the fine FFT filter is used. The Auto setting sets the frequency resolution and the sweep time to an appropriate RBW value according to the span. The Manual setting sets the RBW to a desired value when the signal should be analyzed more accurately or when the signal should be processed rather than the accuracy of signal analysis. A734 has RBW values which can be set according to the span and the value can be changed and applied by using the Up/Down keys or the rotary knob.

The signal which has been processed through RBW is selected as a valid data according to the Detector(F5) setting. In other words, the sweep data which have been processed through RBW are extracted based on the Detector type setting and displayed through VBW(F2).

#### **4.4.1 RBW(F1)**

The RBW is an IF filter which determines how highly the two adjacent frequency signals can be resolved. As the RBW value is smaller, the resolution gets higher; however, the amount of data to process gets relatively larger, causing larger sweep time. If A734 RBW is set to Auto, the RBW value is automatically changed to the value which can provide appropriate frequency resolution and sweep time based on the span setting. The default setting (Factory Preset) is Auto and users can change it to Manual.

## Key Stroke Sequence

BW/SWP → RBW(F1)

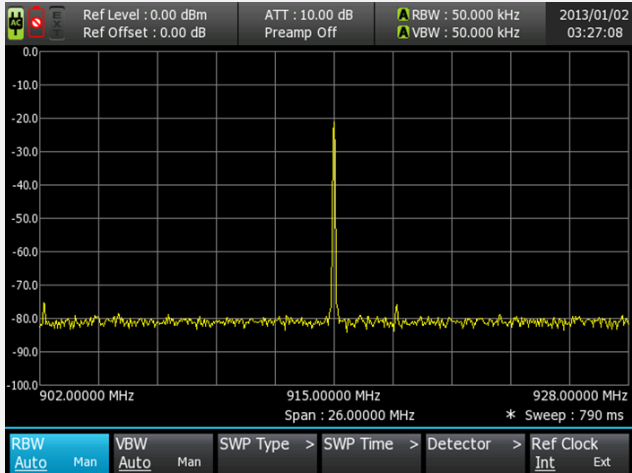

## Auto

- Automatically sets the appropriate RBW according to the span
- Operation: automatic setting



## Manual

- Sets the RBW to the user-specified value
- Operation: Up/Down keys or Rotary knob

As shown in the above table, press the RBW(F1) key repeatedly to set to Auto or Manual. When Auto is set, Auto is displayed and the font gets a little bit bigger as shown in the left figure. In addition “A” is displayed in front of the top RBW icon. When Manual is set, Man is displayed and the font gets a little bit bigger as shown in the right figure. In addition “M” is displayed in front of the top RBW icon.

In the Auto setting, the RBW is automatically changed according to span change. In the Manual setting, the RBW can be changed by using the Up/Down keys and the rotary knob as shown below.

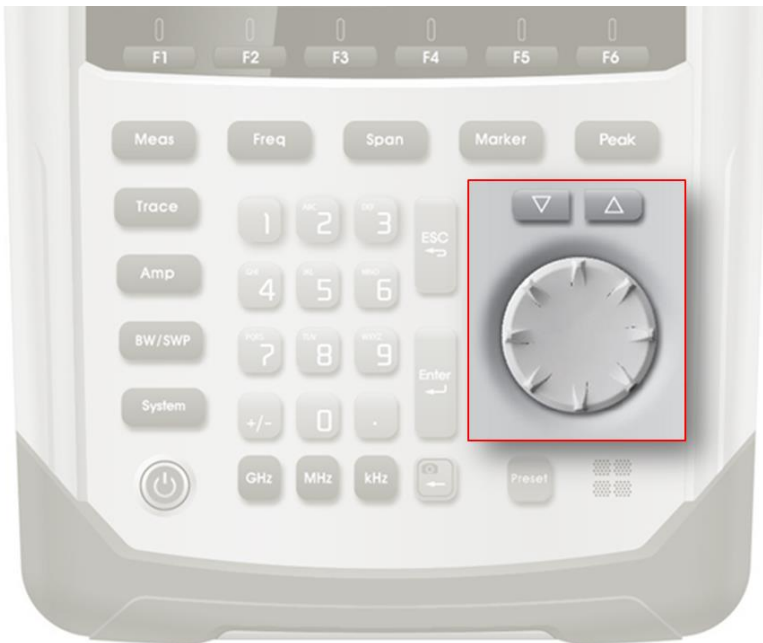



Figure 4-13 RBW Control (Up/Down Key & Rotary)





The RBW can be controlled manually only when the RBW is activated and the setting is Manual. When deactivated, the RBW cannot be changed.

**Table 4-25 RBW Active & De-active**

Activated	Deactivated
 <p>RBW Auto <u>Man</u></p>	 <p>RBW Auto <u>Man</u></p>

As shown in the table below, you can change the RBW by using the Up/Down keys and the rotary knob while the RBW is activated.

**Table 4-26 RBW Manual Changing (Up/Down Key & Rotary knob)**

Up/Down Key	Rotary	Action
		Sets the RBW to the value lower than the current value.
		Sets the RBW to the value higher than the current value.

**Notice**



The Notice window appears; saying that the sweep speed is slow according to the Span, RBW, VBW and Sweep Type setting. If this window is displayed, sweep stops; press the ESC key or the Enter key to close the Notice window.





## 4.4.2 VBW(F2)

The VBW is a low pass filter which processes the sweep data which have been filtered by RBW and Detector(F5). The VBW lowers the range of noise level change. The data before being filtered by VBW has a wide range of trace change (point to point size). However, after VBW, the data has a narrow range of trace change. Therefore, a small VBW value is good for users to measure the spurious signals adjacent to the noise level.

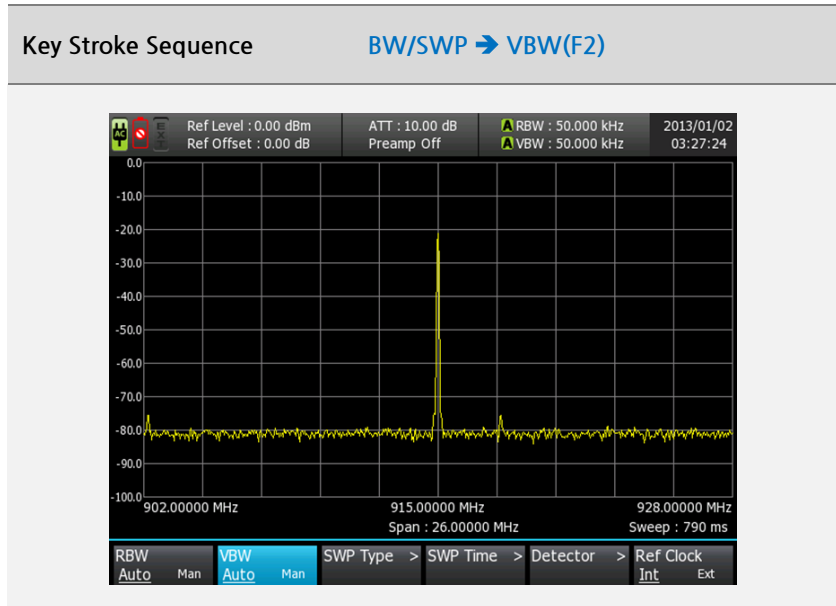

## Auto

- Automatically sets the appropriate VBW according to the RBW
- Operation: automatic setting

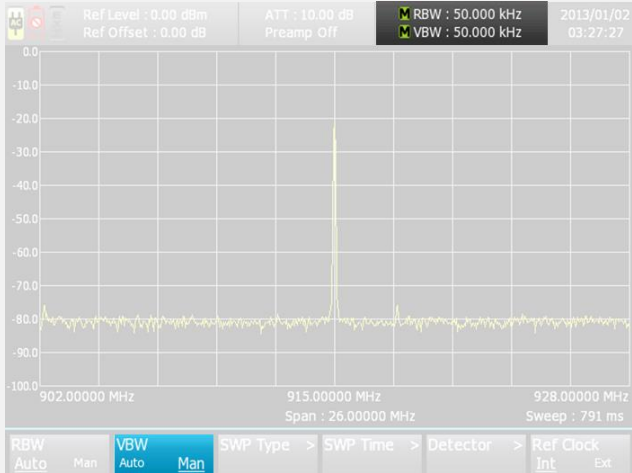

## Manual

- Sets the VBW to the user-specified value
- Operation: Up/Down keys or Rotary knob



### Notice

In the Manual setting, the VBW value should not be larger than the RBW value; it should be always the same or the smaller value than the RBW value.

As shown in the above table, press the VBW(F2) key repeatedly to set to Auto or Manual. When Auto is set, Auto is displayed and the font gets a little bit bigger as shown in the left figure. In addition “A” is displayed in front of the top VBW icon. When Manual is set, Man is displayed and the font gets a little bit bigger as shown in the right figure. In addition “M” is displayed in front of the top VBW icon.

In the Auto setting, the VBW is automatically set to the same as RBW. In the Manual setting, the VBW can be changed by using the Up/Down keys and the rotary knob as shown below.

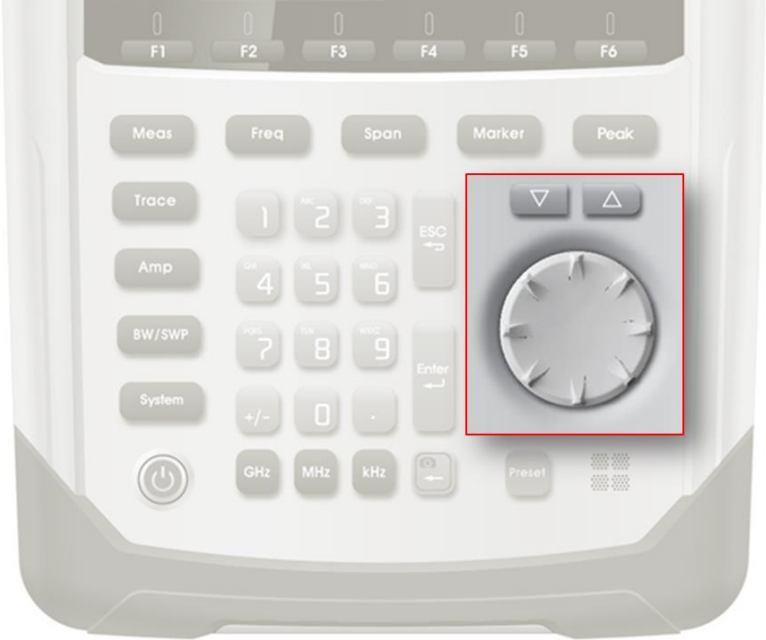

**Figure 4-14 VBW Control (Up/Down Key & Rotary knob)**





Like the RBW, the VBW can be controlled manually only when the VBW is activated and the setting is Manual. When deactivated, the VBW cannot be changed

**Table 4-27 VBW Active & De-active**

Activated	Deactivated
	

As shown in the above table, you can change the VBW by using the Up/Down keys or the rotary knob while the VBW is activated as shown in the following table.

**Table 4-28 Changing VBW Manually (Up/Down Key & Rotary knob)**

Up/Down Key	Rotary	Action
		Sets the VBW to the value lower than the current value.
		Sets the VBW to the value higher than the current value.

**Notice**



The Notice window appears; saying that the sweep speed is slow according to the Span, RBW, VBW and Sweep Type setting. If this window is displayed, sweep stops; press the ESC key or the Enter key to close the Notice window.



### 4.4.3 SWP Type(F3)

The SWP Type allows you to set the sweep type to Single Sweep, Continuous Sweep or External Trigger mode. Press the SWP Type(F3) key and the bottom menu is changed to the sub layer as shown in the following figure. The F6 Return is used to move to the upper layer.

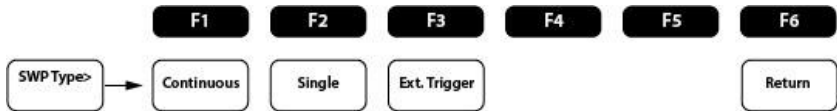

Continuous(F1), Single(F2) and Ext.Trigger(F3) indicate the trace status and you must set one from the three. As shown in the left figure, when the bottom menu F1(Continuous) is activated, the Single mode and the Ext.Trigger mode are deactivated. At this time, the trace is continuously updated according to the sweep. As shown in the center figure, when the bottom menu F2(Single) is activated, the Continuous mode and the Ext.Trigger mode are deactivated. At this time, the trace displayed is the sweep data at the time of pressing the F2 key. To distinguish from the system down status, 'Single Sweep' is displayed on the left top of the LCD.

## Key Stroke Sequence

BW/SWP → SWP Type(F3)

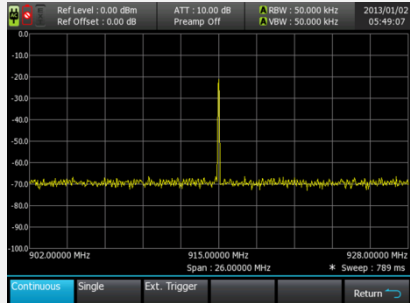

## Continuous

- Updates the trace according to the sweep.

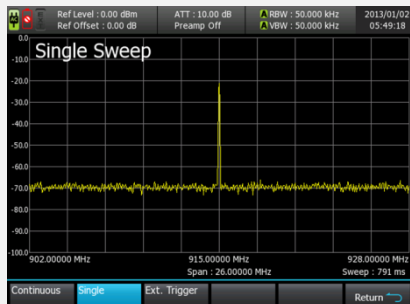

## Single

- Displays the sweep data at the time of pressing the Single(F2) key.  
The trace is not updated any more.

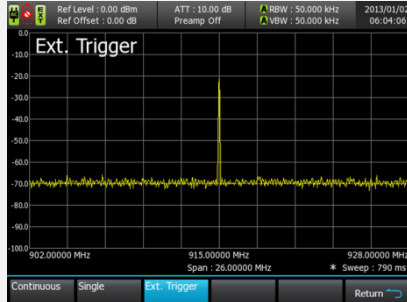

### Ext.Trigger

- Execute sweep according to the rising edge of the Ext.Trigger.

### Notice



Continuous(F1), Single(F2) and Ext.Trigger(F3) are to set the trace status and you must set one from the three. Therefore, two or more settings are unavailable at the same time. The activated one is colored blue when the F1, F2 or F3 key is pressed in the order of Continuous, Single and Ext.Trigger.

The External Trigger is available only when Zero Span is activated. To set this function, you need to execute Zero Span with the desired frequency. Press the Ext.Trigger(F3) to set it and then connect the trigger signal to the A734 Ext.Trigger terminal.

**Table 4-29 Ext. Trigger Setting**

1	Zero Span setting: Span → <b>Zero Span(F3)</b>
2	Ext. Trigger setting: <b>BW/SWP</b> → <b>Sweep Type(F3)</b> → <b>Ext. Trigger(F3)</b>
3	Cable connection: 3.3V CMOS/TTL input



**Notice**

Even if you have been set to the Ext. Trigger(F3) mode, the operation is Continuous sweep until the cable is connected. When the cable is connected and the 3.3V CMOS/TTL signal is successfully provided. Sweep is executed at the rising edge and stopped at the falling edge.

When the mode is set to the External trigger mode, “Ext. Trigger” is displayed on the top right side of the LCD and the Ext icon in the icon block on the top of the LCD is turned on. The following table shows description of the Trigger status.

**Table 4-30 Trigger Descriptions**

<b>Free Run</b>	Start new sweep when a sweep ends. (Normal operating status)
<b>Ext. Trigger</b>	Sweep is started at the rising edge of the external trigger signal. <ul style="list-style-type: none"><li>• <u>External Trigger Signal</u> 3.3V TTL/CMOS</li></ul>



#### 4.4.4 SWP Time(F4)

The SWP Time can be set to three stages: Fast, Medium and Slow. The default setting is Fast. For more accurate measurement, you can set it to Medium or Slow. Press the SWP Time(F4) key to change the bottom menu to the lower layer menu as shown below.

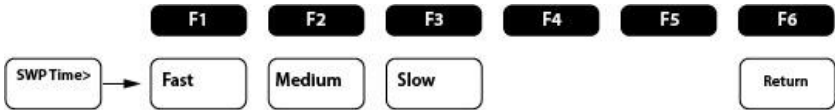

\*Return(F6) : Moves to the upper layer of the bottom menu.

Figure 4-15 SWP Time Menu-tree

The Fast(F1), Medium(F2) and Slow(F3) are used to set the sweep data processing speed and one of the three must be selected. As shown in the left figure below, when the bottom menu F1(Fast) is activated, Medium and Slow are deactivated and the sweep data processing speed is the highest. As shown in the center figure below, when the bottom menu F2(Medium) is activated, Fast and Slow are deactivated and the sweep data processing speed is the medium. As shown in the right figure below, when the bottom menu F3(Slow) is activated, Fast and Slow are deactivated and the sweep data processing speed is the lowest, but the measurement result is most accurate.

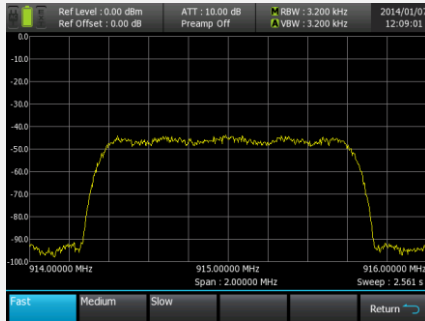

Fast

- The sweep data is processed with the fastest speed.

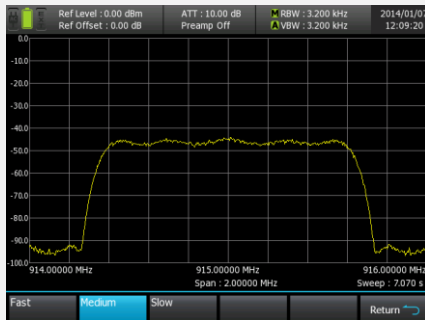

Medium

- The sweep data is processed with the medium speed.

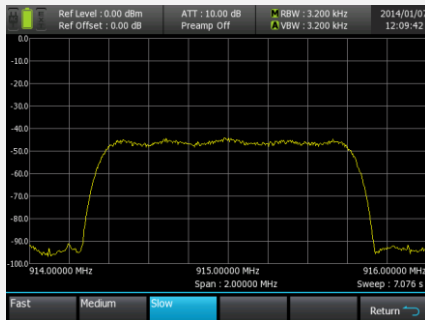

## Slow

- The sweep data is processed with the slowest speed.



### Notice

Sweep time is not applied at all conditions. Sweep time can be applied at the section that the VBW is smaller than 3.2 kHz. Therefore, when the VBW is larger than 3.2 kHz, the amount of sweep data collected is small and there is no change even if Medium or Slow is applied.



### Notice

The Slow mode provides the highest accuracy for measurement result even though the sweep time is low. Therefore, it is recommended to use the Slow mode when you need accurate measurement.



### Notice

A Notice window appears; saying that the sweep speed is slow according to the Span, RBW, VBW and Sweep Type setting. If this window is displayed, sweep stops; press the ESC key or the Enter key to close the Notice window.



## 4.4.5 Detector(F5)

There are four ways to detect the A734 sweep data: Max, Min, Sample and Average. Among this, Average allows you to choose one of the three modes: Power, Voltage and Log. Press the Detector(F5) key to change the bottom menu to Max(F1), Min(F2), Sample(F3) and Average(F4) as shown below. For Max(F1), Min(F2) and Sample(F3), when one of the three is set, the selected data extraction type is applied immediately. For Average(F4), choose Average among Power(F1), Voltage(F2) and Log(F3) as shown below.

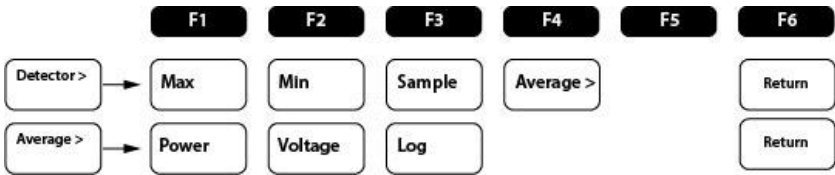
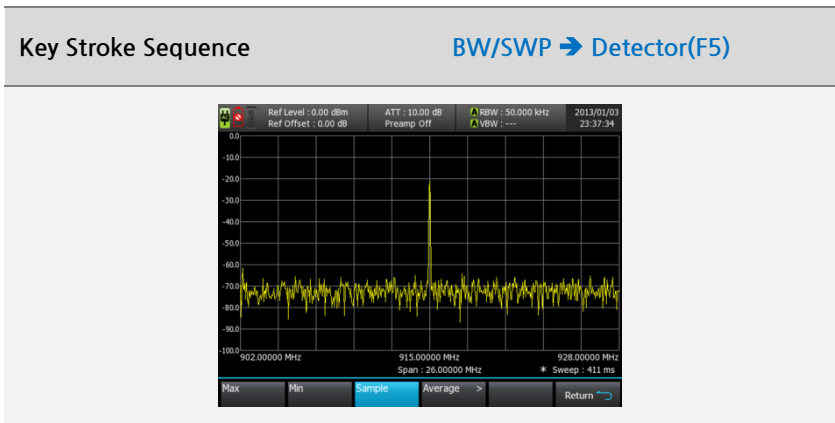

Figure 4-16 Detector Menu-tree

Setting Detector(F5) is to set the data extraction type of A734 and one type must be set. The following table describes the sub layer of each Detector(F5) type and how to set it.



## Sample

- Default setting type
- Randomly extracts and displays the sweep data.
- VBW cannot be applied while the Sample is set

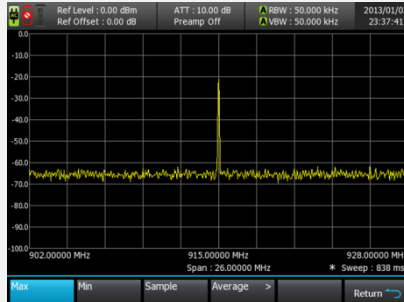

## Max

- Extracts and displays the largest value among the sweep data in the frequency area.

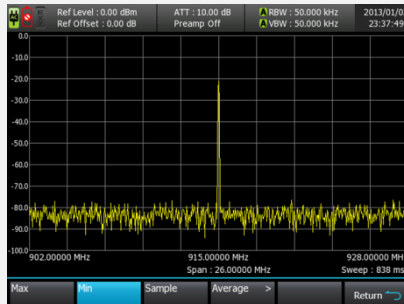

## Min

- Extracts and displays the smallest value among the sweep data points in the frequency area.

The Average provides following functions. When converting from I/Q data to unprocessed amplitude data, the amplitude may be represented as voltage, linear power, or logarithmic power data. Select linear power for RMS power measurements. Logarithmic power is closest to a traditional

spectrum analyzer in log scale

Key Stroke Sequence BW/SWP → Detector(F5) →  
Average(F4)

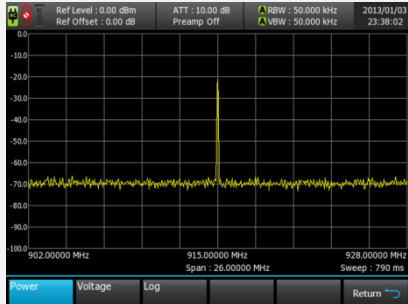

### Power

- Averages the amplitude information of the extracted data by using RMS.
- Used for RMS power measurement.

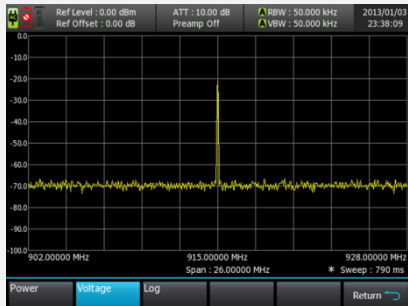

### Voltage

- Averages the amplitude information of the extracted data by using Voltage scale.

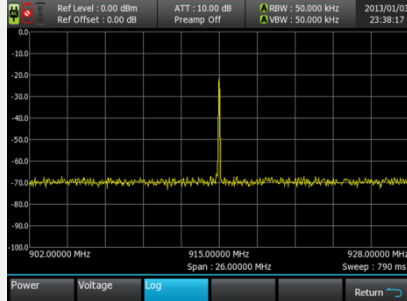

### Log

- Averages the amplitude information of the extracted data by using Log scale.
- Same with the Log scale of the previous spectrum.



### Notice

When the Detector type is set to Sample, VBW cannot be applied. Therefore, the Sample type provides the fastest sweep speed.

## 4.4.6 Ref. Clock(F6)

A734 provides the TCXO reference time base. Generally, the OCXO time base shows higher stability than the TCXO time base. A734 allows you to set external 10MHz time base when you need measurement results with high frequency accuracy or synchronization. Ref.Clock(F6) provides two options, Int(Internal) and Ext(External), and the default setting is Int. When the external 10 MHz signal is connected to the external Ref. 10MHz In terminal of A734, you can change the setting to Ext by pressing the Ref.Clock(F6) key.

## Key Stroke Sequence

BW/SWP → Ref.Clock(F6)

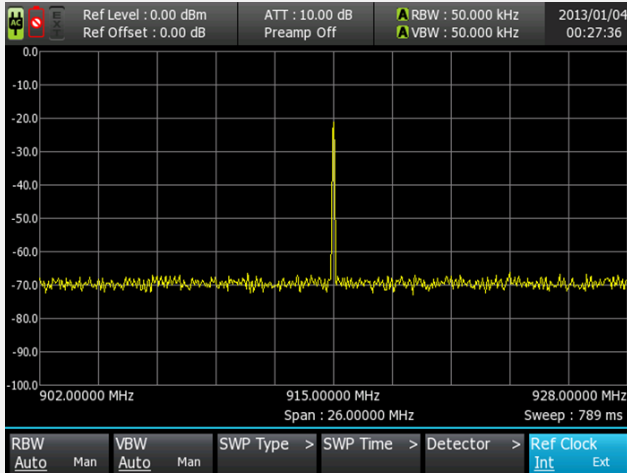

## Int

- Uses the Internal time base.





## Manual

- Uses the External time base.
- Can be set only when signals are provided to the Ref.Clock terminal. When it is set, the EXT icon is turned on.



### **Notice**

To measure the narrow span less than 1 kHz and to measure the phase noise, the external 10 MHz reference may provide the better result.



### **Notice**

When trying to set to Ext while signals are not provided to the external 10 MHz Ref. In terminal, a short message saying that the external connection should be checked is displayed.



### **Notice**

When Ext.Clock is not set while the external 10 MHz Ref. In terminal is connected, measurement may be affected after a certain time period has passed. Therefore, it is recommended to keep the external 10 MHz Ref. In terminal 'Open' when the Ref.Clock is set to Internal.



### **Notice**

When the external 10MHz Ref. In terminal is connected and the Ext.Clock is set, if the cable connected to the terminal is removed without changing the setting to Int.Clock, A734 does not operate normally; sweep may stop or not according to the equipment setting status. Therefore, when the cable is removed, you must change the setting to Int.Clock.

### Notice

When switching the setting from Ext. Reference to Int. Reference, it takes a little time and the following Notice window appears. After the following window appears, sweep will stop until the “RFM OK” short message is displayed. The setting is not completed until the “RFM OK” short message is displayed.

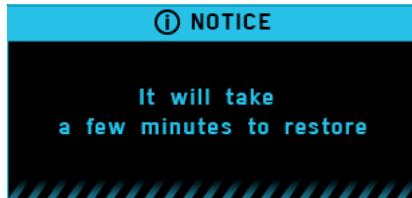

## 4.5 Marker

The Marker is used to check the amplitude and frequency information of a specific point on the trace. A734 provides five markers, M1 ~ M5. Each marker can be selected by pressing the Marker(F1) key and the selected marker status can be set. The marker statuses are three: Normal(F2), Delta(F3) and Off(F4). Normal(F2) is located on the frequency with a normal marker. Delta(F3) displays the difference of amplitude and frequency between the Delta point and a user-specified point (reference point). Off(F4) turns off the marker which has been set. The following figure shows the Marker key.



**Figure 4-17 Marker Control Key**

Press the Marker key to change the bottom menu F1 ~ F6 to the marker items and to set M1 to the center frequency. In other words, Marker(F1) is set to 1 and Normal(F2) is activated. After entering to the Marker menu, you can set the marker number and the status. You can move the marker selected as Marker(F1) by entering the frequency or by using the Up/Down keys or the rotary knob.

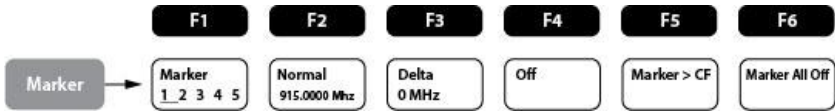

Figure 4-18 Marker Menu-tree

Table 4-31 Marker Menu Descriptions

Item	Select	Description
Marker(F1)	1, 2, 3, 4, 5	Selects one of M1 ~ M5.
Normal(F2)		Sets the selected marker status to Normal. Displays and changes the frequency.
Delta(F3)		Sets the selected marker status to Delta. Displays and changes the difference between the reference point and the Delta point.
Off(F4)		Sets the selected marker status to Off.
Marker→CF(F5)		Moves the frequency of the selected marker to the center frequency.
Marker All Off(F6)		Sets all marker statuses to Off.

On the right top of the main window, the frequency and amplitude of the selected marker is displayed. To view the frequency and amplitude of markers which are not selected, select it by using the Marker(F1) key.

## 4.5.1 Marker(F1)

The Marker(F1) provides the function to select one from M1 ~ M5. A734 provides five markers. By pressing the Marker(F1), set the marker to one of 1 ~ 5 and then set the status to Normal(F2), Delta(F3) or Off(F4) by using the F2, F3 or F4 key. When all markers are Off while you are entering to the Marker menu, the marker becomes M1 and is set to Normal(F2). All markers are located on the center frequency when they are set to Normal(F2). From this location, the markers can be moved to the desired points. The following figure shows the Marker menu.

Key Stroke Sequence

Marker → Marker(F1)

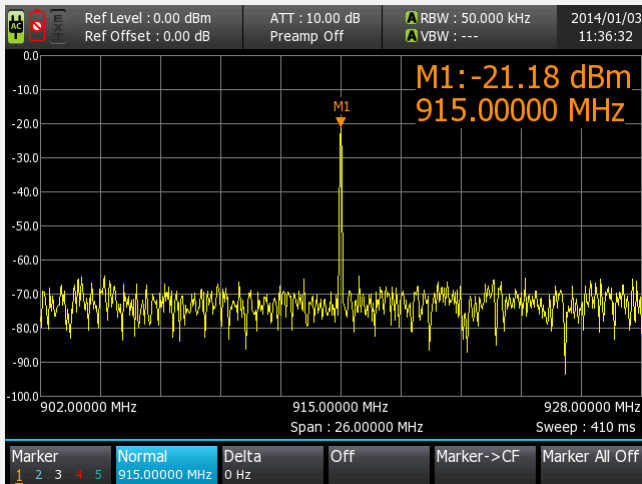

### Marker(F1) Executed

- 1 is selected at the initial entry to the Marker menu
- Press the F1 key to select one from 1 ~ 5.
- Select the marker number and then set the status by pressing one of the F2 ~ F4 keys.

## 4.5.2 Normal(F2)

The Normal(F2) is a general status of a marker, showing the frequency and amplitude information of the point. Select a number to be set as Marker(F1) and then press the Normal(F2) to set the marker on the center frequency of the trace. To move the maker, you can enter the frequency of the marker directly or use the Up/Down keys or the rotary knob. The following figure shows that M1 is set to Normal(F2) and the marker frequency input window is opened.

Key Stroke Sequence

Marker → Normal(F2)

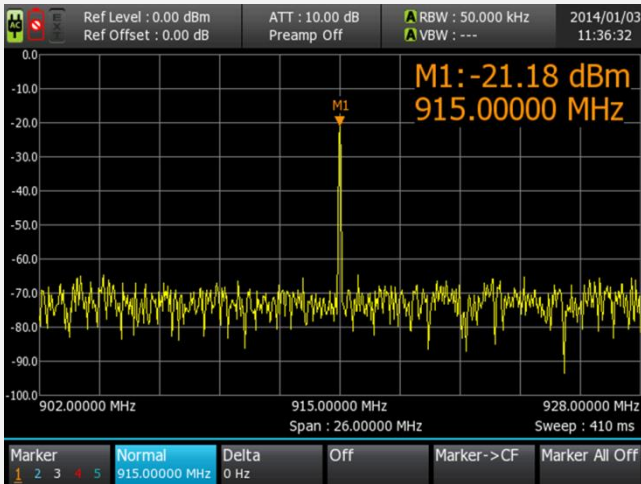

### M1 Normal(F2) Status

- When pressing the Marker key, the Normal status is activated by default.
- To set another number, select the number by pressing the Marker(F1) key and then press the Normal(F2) key.

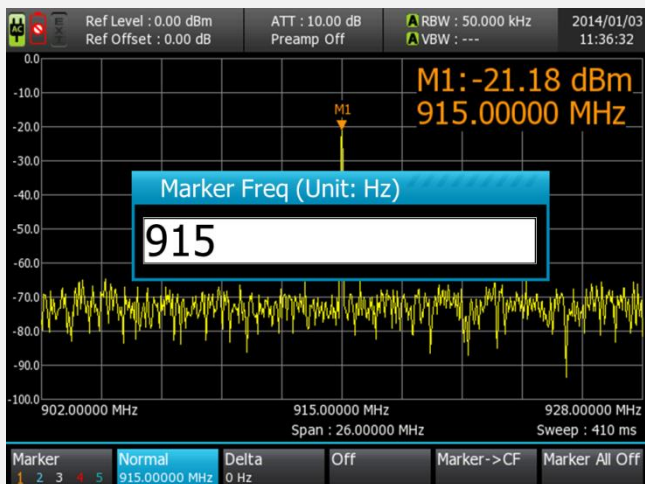

### M1 Normal(F2) Input Window

- While Normal(F2) is activated, press the number key to display the input window.
- Enter the marker frequency value and then press the Unit key or the 'Enter' key to complete the setting.
- To close the window without saving the setting, press the ESC key.

When the marker is set as shown in the above figure, the frequency and amplitude of the selected marker is displayed on the right top of the main window. Even when all of M1 ~ M5 have been set, the information of the selected marker is displayed on the right top of the screen. To view the frequency and amplitude of markers which are not selected, select it by using the Marker(F1) key. You can change the location of the selected marker by following the orders in the table below.

### Changing the Normal marker location with Numeric keys

**Table 4-32 Changing Normal Marker Frequency (with number keys)**

1	<b>Set to Normal(F2)</b>	Set the selected marker status to Normal(F2).
2	<b>Open the Marker frequency input window</b>	Press the number key while the status is set to Normal(F2) and then the marker input window will be displayed. (press the first number of the marker frequency to be changed)
3	<b>Enter the marker frequency value</b>	Enter the frequency value where the marker will be located.
4	<b>Unit key or Enter key press</b>	Unit key → Moves the marker to the location with the entered frequency and Unit key information. ‘Enter’ key → Moves the marker with the entered value.

The activated status is indicated as the item box in blue as shown in the following table.

**Table 4-33 Normal Active & De-active**

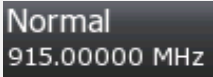
Normal(F2) Status	Other Statuses except Normal(F2)
	

**Changing the Marker location with the Up/Down keys or the rotary knob**



On the trace, you can change the location of the marker which has been set to Normal(F2) or Delta(F3) and selected with Marker(F1) by using the Up/Down keys or the rotary knob. When pressing ▽ or rotating the rotary knob to the counterclockwise, the marker is moved to the lower frequency direction. When pressing △ or rotating the rotary knob to the clockwise, the marker is moved to the higher frequency direction.







Figure 4-19 Marker Control (Up/Down Key & Rotary knob)

**Table 4-34 Changing Normal Marker Frequency  
(Up/Down Key & Rotary knob)**

Item	DitECTION	Description
	Lower	1 push -> Moves the marker toward the lower frequency by Span/10
	Upper	1 push -> Moves the marker toward the higher frequency by Span/10

	Lower	1 click -> Moves the marker toward the lower frequency by 1 point
	Upper	1 click -> Moves the marker toward the higher frequency by 1 point

The marker in Normal status can be moved from the start frequency to the stop frequency. If you want to view the frequency out of the span, you need to adjust the frequency range setting.



#### Notice

When you manually enter the marker frequency lower than the current start frequency or higher than the stop frequency, the marker is located on the start frequency point or on the stop frequency point.

### 4.5.3 Delta(F3)

The Delta(F3) displays the difference of frequency and amplitude between the reference point and the Delta point. Select a number to be set as Delta by pressing the Marker(F1) key and press the Delta(F3), and then the reference marker and the delta marker are displayed on the trace. When setting Delta(F3) while the marker status is Off, the reference marker and the Delta marker are located on the center frequency. When the marker status is changed from Normal(F2) to Delta(F3), the reference marker and the Delta marker are set on the current marker location. The amplitude of the reference marker is fixed, so it is not changed even when the trace is changed because of sweep. On the other hand, the Delta marker is always on the trace and users can change the delta marker location. The following figure shows that the Marker 1 has been set to Delta(F3) and the Delta marker has been moved.

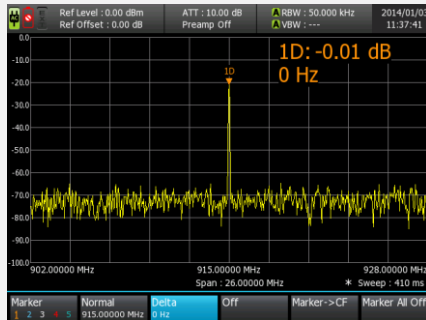

### Delta(F3) Setting

- When the Marker 1 is set to Delta(F3), 1R and 1D are displayed on the center frequency.
- Regardless of sweep, 1R has the same amplitude and frequency.
- 1D is moved along the trace according to sweep.

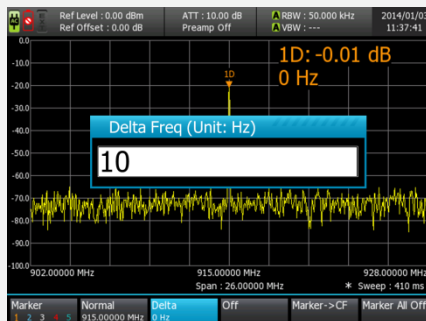

### Delta(F3) Input Window

- While Delta is activated, press the number key to display the input window.
- Enter the frequency difference between 1R and 1D (1R is fixed and 1D is moved.)
- Press the Unit key or the Enter key.

- To close the window without saving the setting, press the ESC key.

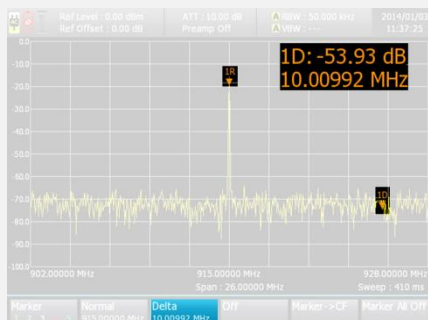

### Moving Delta marker

- Moves 1D to the location which is 10 MHz far from 1R.
- The marker information on the right top side shows the difference of frequency and amplitude between 1R and 1D.

When the Delta is set as shown in the above figure, the difference of frequency and amplitude between the reference marker and the Delta marker is displayed on the right top side of the screen. Like Normal, it displays the information of the selected number only. The Delta marker can be moved to the frequency out of the current frequency range. The following table shows how to change the Delta marker location.

### Changing the Delta marker location with Numeric keys

**Table 4-35 Changing Delta Marker Frequency (with number keys)**

<b>1</b>	<b>Set to Delta(F3)</b>	Set the selected marker status to Delta(F3). *The reference marker should be moved to the location first as Normal status.
<b>2</b>	<b>Open the Delta frequency input window</b>	Press the number key while the status is set to Delta(F3) and then the Delta input window will be displayed. (press the first

		number of the Delta frequency to be changed).
3	<b>Enter the Delta frequency value</b>	Enter the difference of frequency and amplitude between the reference marker and the Delta marker
4	<b>Unit key or Enter key press</b>	Unit key → Moves the Delta marker to the location with the entered frequency and Unit key information. 'Enter' key → → Moves the Delta marker the location with the entered frequency difference.

The activated status is indicated as the item box in blue as shown in the following table.

**Table 4-36 Delta Active & De-active**

Delta(F3) Status	Other Statuses except Delta(F3)
Delta 10.00992 MHz	Delta 0 Hz



**Changing the Delta Marker location with the Up/Down keys or the rotary knob**

At the Delta(F3) status, the reference marker is fixed and the Delta marker moves. When pressing ▾ or rotating the rotary knob to the counterclockwise, the Delta marker is moved to the lower frequency direction. When pressing ▴ or rotating the rotary knob to the clockwise, the Delta marker is moved to the higher frequency direction.



Figure 4-20 Delta Marker Control (Up/Down Key & Rotary knob)

**Table 4-37 Changing Delta Marker Frequency (Up/Down Key & Rotary knob)**

Item	DitECTION	Description
	Lower	1 push -> Moves the Delta marker toward the lower frequency by Span/10
	Upper	1 push -> Moves the Delta marker toward the higher frequency by Span/10
	Lower	1 click -> Moves the Delta marker toward the lower frequency by 1 point



Upper

1 click -> Moves the Delta marker toward the higher frequency by 1 point

---

The Delta marker can be applied to the frequency out of the current span. However, when moving to the frequency out of the span, adjust the start frequency and the stop frequency. At this time, the reference marker is fixed on the initial setting position.

The Delta marker can be applied to the frequency out of the current span. However, to move to the frequency out of the span area, you must adjust the start frequency and the stop frequency. At this time, the reference marker is fixed on the initial location.

#### 4.5.4 Off(F4)

The Off(F4) turns off the selected marker. Select the marker number to turn off by using the Marker(F1) key and then press the Off(F4) key; the selected marker is removed from the screen. All markers are set to one of Normal, Delta and Off. Therefore, Off(F4) is activated for the Off maker. The following figure shows that the Marker 1 has been Off.

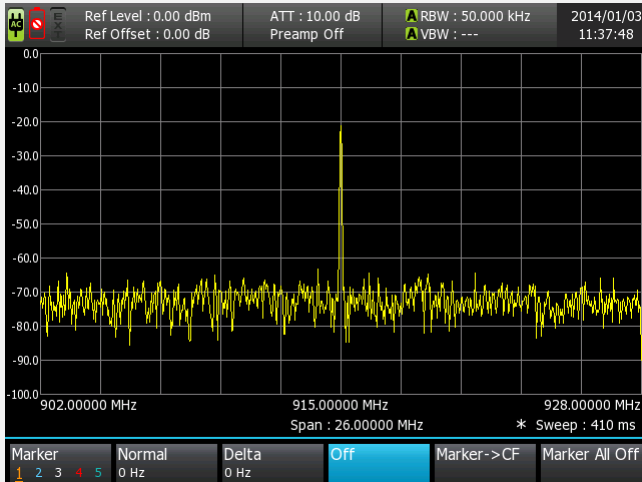

#### Off(F4) status

- Select the marker to set to Off.
- Press the F4 key.

### 4.5.5 Marker →CF(F5)

The Marker→CF(F5) moves the frequency of the selected marker to the center frequency. After moving the marker, press the Marker→CF(F5) key to move the marker frequency to the center frequency with the same span. The following figure shows that the center frequency has been moved to the M1 frequency.



## Key Stroke Sequence

Marker → Marker→CF(F5)

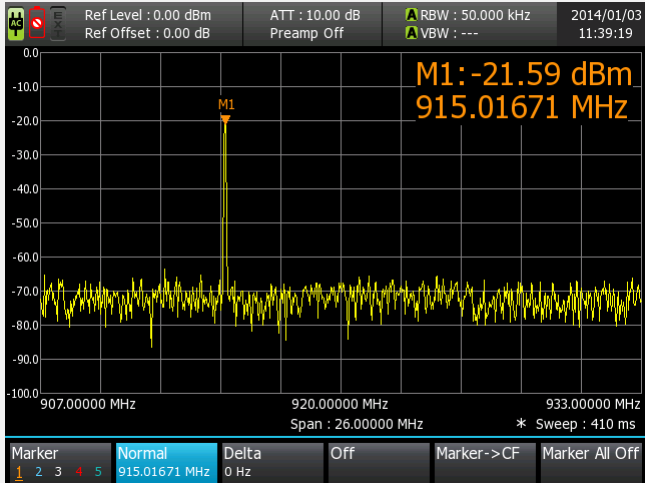

## Before Marker→CF(F5)

- Moves the marker to the desired location.

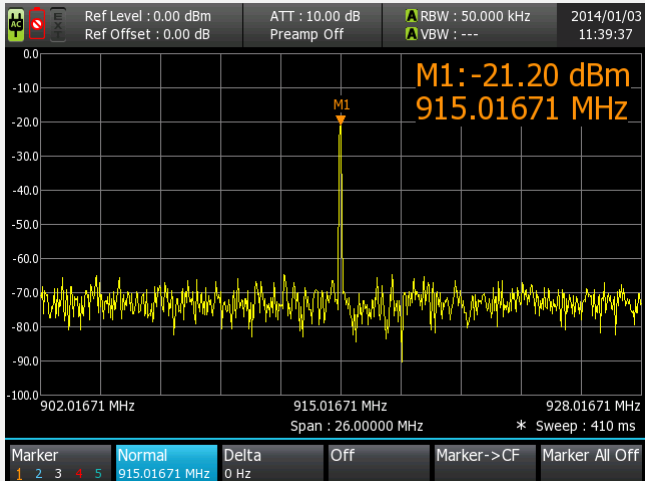

### After Marker→CF(F5)

- After moving the marker, press Marker→CF(F5).
- The marker frequency is changed to the center frequency (with the same span).

## 4.5.6 Marker All Off(F6)

The Marker All Off(F6) sets the status of all markers from 1 to 5 to Off. You do not have to select the number. After executing this, all markers are Off(F4).

### Key Stroke Sequence

Marker → Marker All Off(F6)

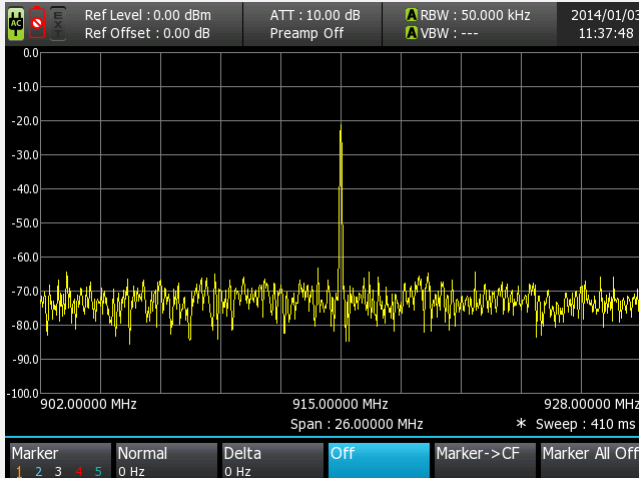

### Marker All Off(F6) Screen

- When executing Marker All Off(F6), all markers are Off and Off(F4) is activated.

## 4.6 Trace

The Trace allows you to control the trace status according to sweep. Clear Write(F2), Max Hold(F3), Hold(F4), Off(F5) and Average(F6) are available. After selecting one from T1, T2 and T3 by using the Trace(F1) key, select one of F2 ~ F6. The following figure shows the location of the Trace key.



Figure 4-21 Trace Control Key

Press the Trace key and the bottom menu F1 ~ F6 are changed to the trace items. When the A734 is in the default status, the yellow trace is T1, the green is T2 and the purple is T3. Press the Trace(F1) key to select one from T1 ~ T3. After selecting the trace, set the status by using the F2 ~ F6 keys. The following table shows the description of each status. F6 Average has its sub menus: Average(F1) and Count(F2).

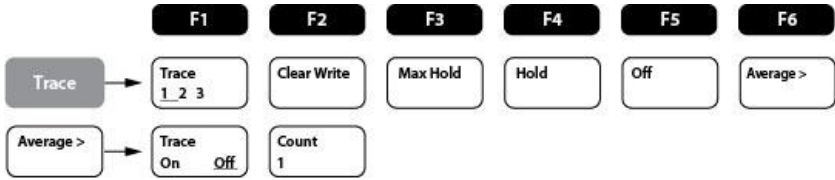

Figure 4-22 Trace Menu-tree

Table 4-38 Trace Menu Descriptions

Item	Select	Description
Trace(F1)	1, 2, 3	Toggles among T1 ~ T3
Clear Write(F2)		Updates the selected trace according to sweep.
Max Hold(F3)		Updates each point of the selected trace to the max. value according to sweep.
Hold(F4)		Keeps the selected trace executed.
Off(F5)		Turns off the selected trace
Average(F6)	Average(F1) On, Off	Averages the sweep data of each point as much as the count.
	Count(F2)	Sets the average count (from 1 to 20)



**Notice**

Average can be used only in the Clear Write status; it does not work in Max Hold, Hold or Off.



### Notice

When setting the marker while Trace has been set, the marker is located on the selected trace. When T1 is selected, the marker is located on the yellow trace. When T2, located on the green trace. When T3, located on the purple trace.

## 4.6.1 Trace(F1)

The Trace(F1) allows you to select one from T1 ~ T3. A734 provides three trace types and the type can be selected by pressing the Trace(F1) key. Each trace is distinguished in color and the default is T1 (yellow) in the Clear Write(F2) status. T2 (green) and T3 (purple) are set to Off(5). To change the setting, press the Trace(F1) key to change the number and then change the status by using F2 ~ F6 keys. The following figure shows that the Trace menu has been activated by pressing the Trace key.

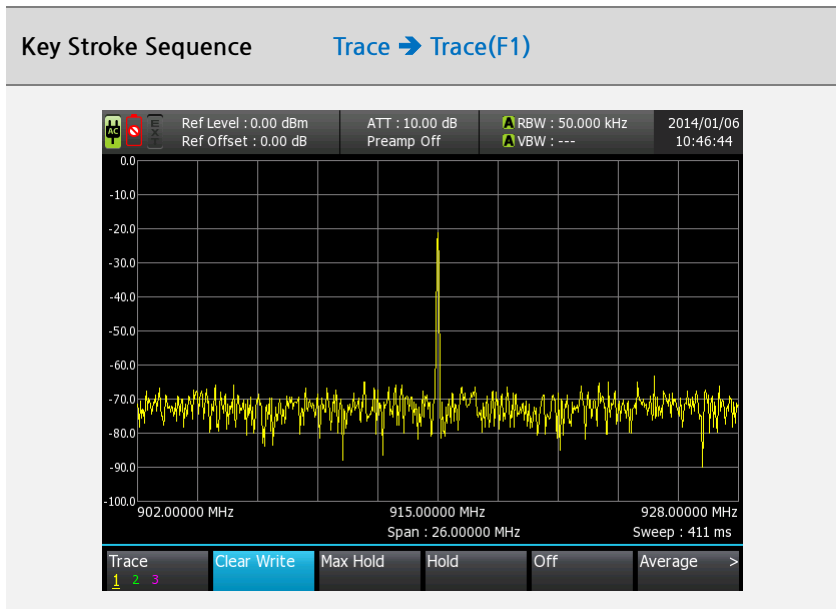

### Executing Trace(F1)

- The default setting is T1 (yellow) and the status is Clear Write.
- Press the F1 key to select one from T1 ~ T3.
- Select the desired trace number and then set the status by using F2-F6.

As shown in the above figure, the current T1 (yellow) is in the Clear Write(F2) status. Therefore, the Trace(F1) status has 1 with under bar and the Clear Write(F2) is activated. In the above status, when T2 is selected in the Trace(F1), T2 is now in the Off(5) status and the Off(F5) is activated. Like this, the Off(F5) is activated for T3. When the trace status is changed, the changed status is activated. After setting the status of all T1 ~ T3, the trace selected in the Trace(F1) is displayed on the top.

## **4.6.2 Clear Write(F2)**

The Clear Write(F2) is the status updating the trace according to the sweep. When RF sweep is ended, the previous sweep data is removed and the current measured sweep data is displayed on the trace. The following figure shows that T1 has been set to Clear Write.

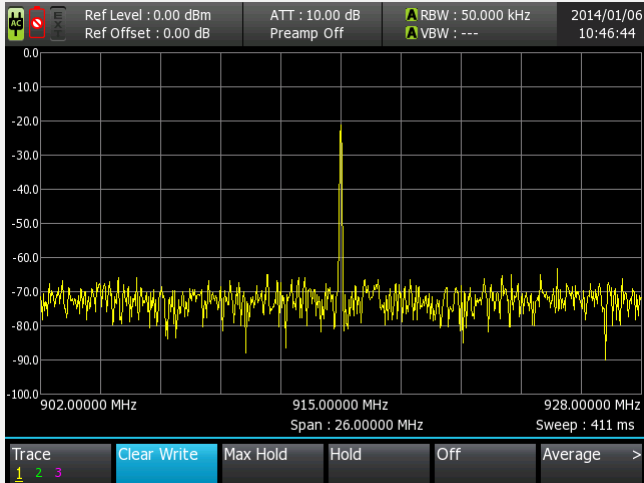

### Clear Write(F2) Setting

- T1 (yellow) is the Clear Write status by default.
- After selecting the number in the Trace(F1), activate it with the F2 key.

If all of the status of T1 ~ T3 are Clear Write(F2), the trace displayed in the screen are overlapped. Therefore, only one trace is displayed and the trace selected in the Trace(F1) is the foremost. In this case, when T1 is selected, the yellow trace is displayed. When T2 is selected, the green trace is displayed. When T3 is selected, the purple trace is displayed on the screen.

## 4.6.3 Max Hold(F3)

The Max Hold(F3) compares each point of trace according to the sweep with the previous amplitude value and updates the value to the larger one. After RF sweep has ended, when the amplitude of the point is larger than the previous value, the previous amplitude is replaced with the current sweep data. When the amplitude of the point is smaller than the previous value, the previous amplitude is kept. Until the status is changed, each point is updated with the larger value whenever sweep is executed. The following figure shows that the setting is Max Hold.

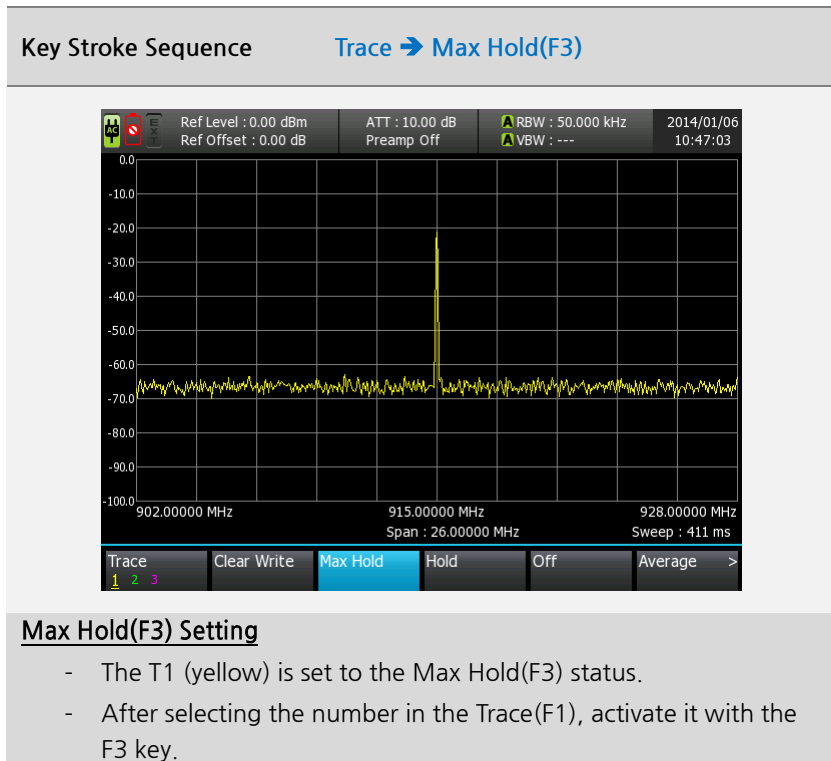

The Max Hold status is used to detect a temporary spurious or a momentary change. Therefore, it can be observed only when it is set for a



sufficient time period according to the sweep speed. When the configuration such as the frequency is changed in the Max Hold(F3) status, the Max Hold(F3) is reset. At this time, when the F3 key is pressed again, Max Hold is started from the moment that the key is pressed.

## 4.6.4 Hold(F4)

The Hold(F4) holds the selected trace as the trace when Hold is set. In other words, when Hold is executed while it is in the Clear Write status, the trace with the sweep data at the time of executing Hold is kept. Like that, when Hold is executed while it is in the Max Hold status, the trace with the sweep data at the time of executing Hold is kept. Therefore, in any status, the trace at the moment that Hold(F4) is set is displayed on the screen and kept. The following figure shows that T1 is in Hold while it is in the Clear Write status.

Key Stroke Sequence      Trace → Hold(F4)

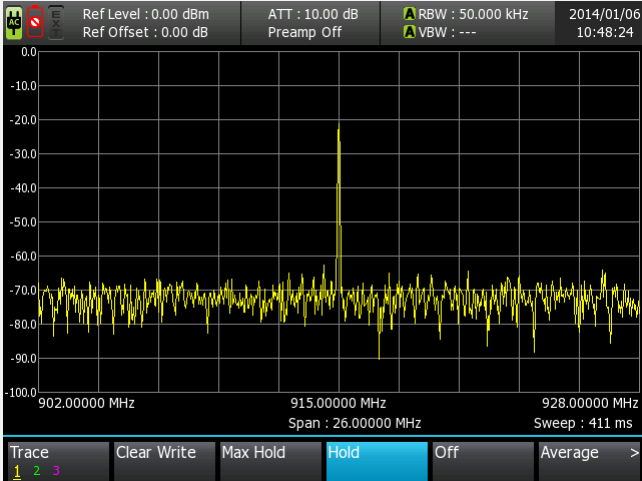

The screenshot displays a spectrum analyzer interface. At the top, there are several status indicators: 'Ref Level : 0.00 dBm', 'Ref Offset : 0.00 dB', 'ATT : 10.00 dB', 'Preamp Off', 'RBW : 50.0000 kHz', 'VBW : ---', and the date/time '2014/01/06 10:48:24'. The main display area shows a signal trace in yellow on a black background with a grid. The vertical axis represents power in dBm, ranging from 0.0 to -100.0. The horizontal axis represents frequency in MHz, ranging from 902.00000 to 928.00000, with a span of 26.00000 MHz and a sweep time of 411 ms. A prominent signal peak is visible at approximately 915.00000 MHz. At the bottom of the interface, there is a control bar with buttons for 'Trace', 'Clear Write', 'Max Hold', 'Hold', 'Off', and 'Average'. The 'Hold' button is highlighted in blue, indicating it is the active status.

**Hold(F4) Setting**

- The T1 (yellow) is set to the Hold(F4) status.
- After selecting the number in the Trace(F1), activate it with the F4 key.

Different from Clear Write or Max Hold, in Hold, the trace is not updated according to the sweep. Therefore, Hold is used to keep a specific trace without update. In the Hold(F4) status, the trace is kept even though the configuration such as Span is changed.



### Notice

When entering to another menu, not to the Trace menu, in the Hold(F4) status, the screen may seem to stop. Therefore, if the trace is not updated but same, check the Trace setting.

## 4.6.5 Off(F5)

The Off(F5) turns off the selected trace. In other words, it removes the trace from the screen when it is not necessary to view the T1-T3 trace status on the screen. The following figure shows that T1 ~ T3 are Off.

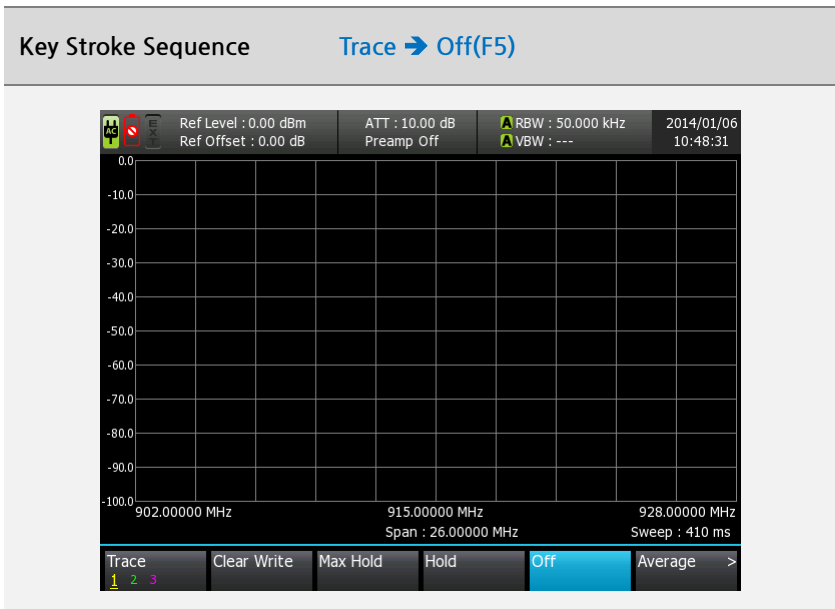

### Off(F5) Setting

- All of T1 ~ T3 are set to the Off(F5) status (all are Off, there is no trace displayed on the screen.)
- After selecting the number in the Trace(F1), activate it with the F4 key.



#### Notice

The Off just remove the displayed trace from the screen, not stops sweep. Therefore, the sweep time is continuously displayed on the right bottom of the screen while the status is Off.

## 4.6.6 Average(F6)

The Average(F6) displays the average of sweep data on the screen as much as the Count(F2) setting. In other words, after displaying the first sweep on the screen, when the sweep count is smaller than the count set in the Count(F6), the data is averaged until the count reaches the count setting. When the sweep count reaches the Count(F6) setting, the oldest sweep data is discarded and the data as many as the count is averaged and displayed on the trace. Pressing the Average(F6) key changes the bottom menu to the Average sub menu and the Average sub menu has Average(F1) and Count(F2).



Figure 4-23 Average Menu-tree

The following figures show that Count(F2) is set to 20 and Average(F1) is On, and the Count(F2) input window is open.

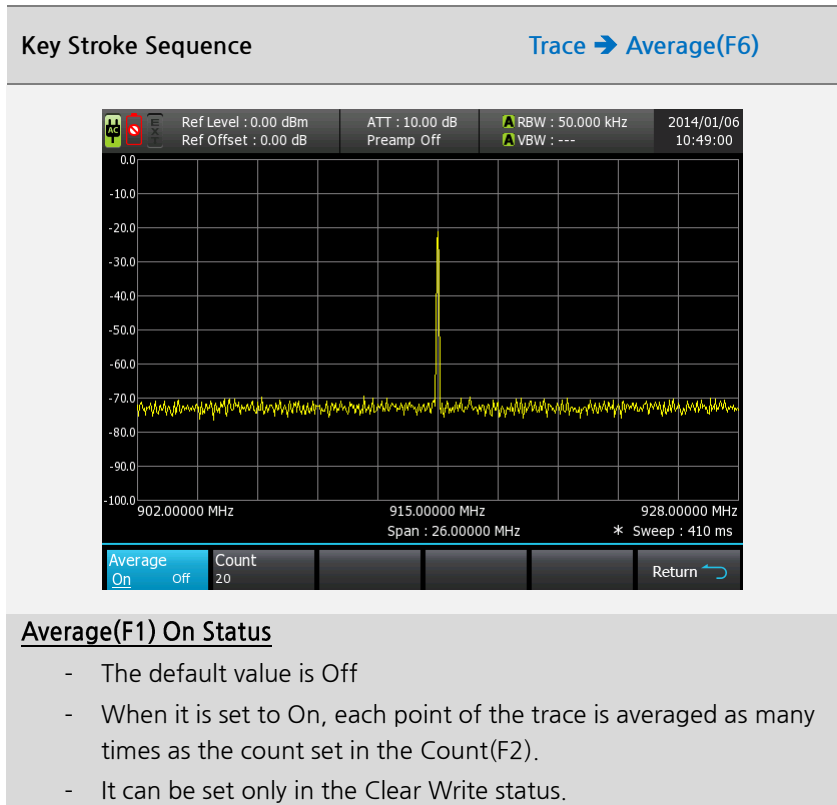

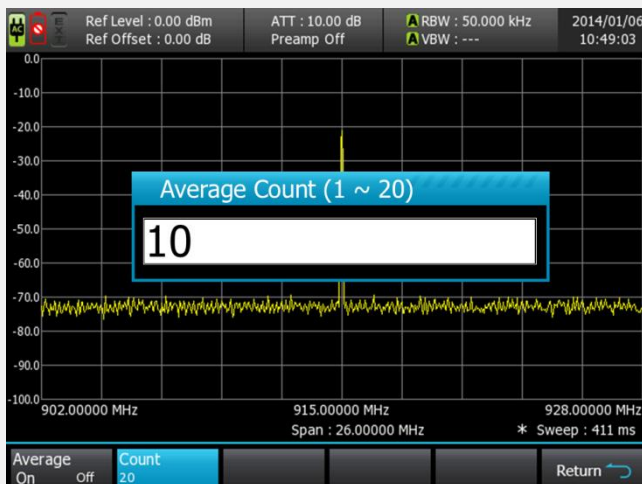

### Conut(F2) Input Window

- While Count(F2) is activated, press the number key to display the input window.
- Enter the count (1 ~ 20) and then press the 'Enter' key to complete the setting.
- To close the window without saving the setting, press the ESC key.

Average can be set only in the Clear Write status. It is mainly used to measure the channel power or ACP.

## 4.7 Peak

The Peak is used to search the highest amplitude point among the measured trace points. When it is executed, the marker is set on the point of which amplitude is the highest. When the Peak key is pressed, the bottom menu is changed to the peak menu. The Peak menu includes Peak Search(F1), Next Peak(F2) and Peak→CF(F3). The following figure shows the location of the Peak key.



Figure 4-24 Peak Control Key

When the Peak key is pressed, the bottom menu is changed to the Peak menu. The following table shows functions of each menu.

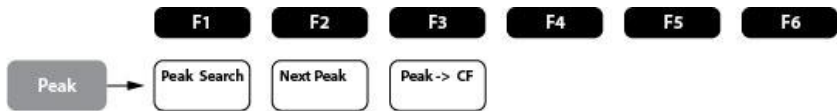

Figure 4-25 Peak Menu-tree

**Table 4-39 Peak Menu Descriptions**

Name	Enable	Description
<b>Peak Search(F1)</b>		<ul style="list-style-type: none"> <li>- Runs like a HW key.</li> <li>- Sets the marker on the highest amplitude point among the sweep data.</li> </ul>
<b>Next Peak(F2)</b>		<ul style="list-style-type: none"> <li>- Moves to the amplitude point smaller than the amplitude point of the current marker.</li> </ul>
<b>Peak→CF(F3)</b>		<ul style="list-style-type: none"> <li>- Among the sweep data, moves the frequency of the highest amplitude point to the center frequency and sets the marker on the point.</li> </ul>

**Notice**

The difference between Peak To Center(F3) and Marker To Center(F5) is as follows.



- Peak→CF(F3): Regardless of the marker setting, the point with the highest amplitude is set to the center frequency and sets the marker on the point.
- Marker→CF(F5): Regardless of the peak, sets the current marker frequency as the center frequency.



## 4.7.1 Peak Search(F1)

The Peak Search(F1) is to search the highest amplitude point on the trace. When it is executed, the marker is placed on the highest amplitude point. When pressing the Peak key, Peak Search is immediately executed. Pressing the Peak key gives the same result with pressing the Peak Search(F1).

### Key Stroke Sequence

Peak → Peak Search(F1)

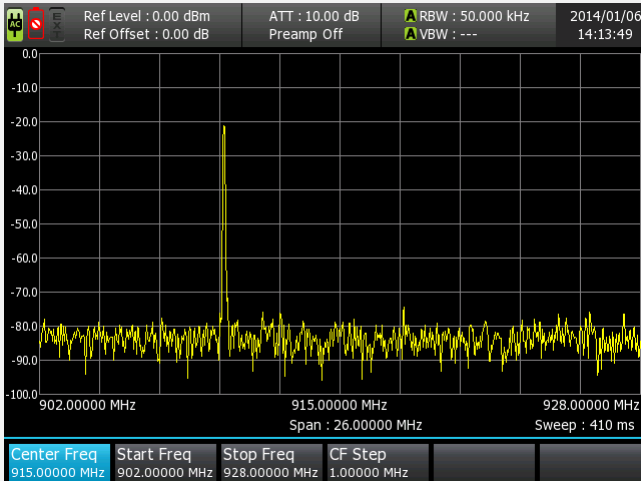

### Before Peak Search(F1)

- Before Peak Search

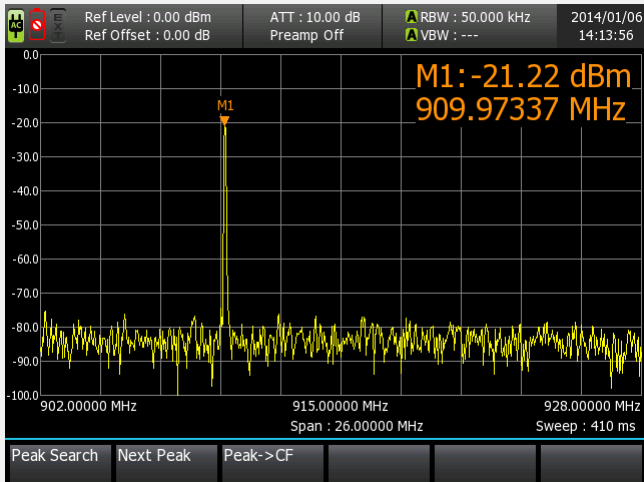

### After Peak Search(F1)

- Sets the marker on the highest amplitude point on the screen.
- Several traces are set on the screen, sets on the current trace.
- When a marker is set, the marker is moved to the peak point.

## 4.7.2 Next Peak(F2)

The Next Peak(F2) moves the marker to the amplitude point which is smaller than the amplitude of the marker. After entering to the Peak menu, one or more markers are always set on the screen. Therefore, the Next Peak(F2) can be always executed in the Peak menu. The following figures display that Peak Search(F1) has been executed and then Next Peak(F2) has been executed.

## Key Stroke Sequence

Peak → Next Peak(F2)

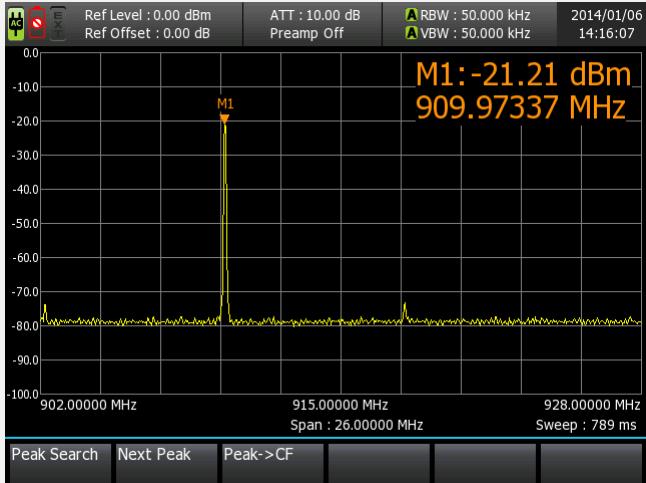

## After Peak Search(F1)

- After Peak Search

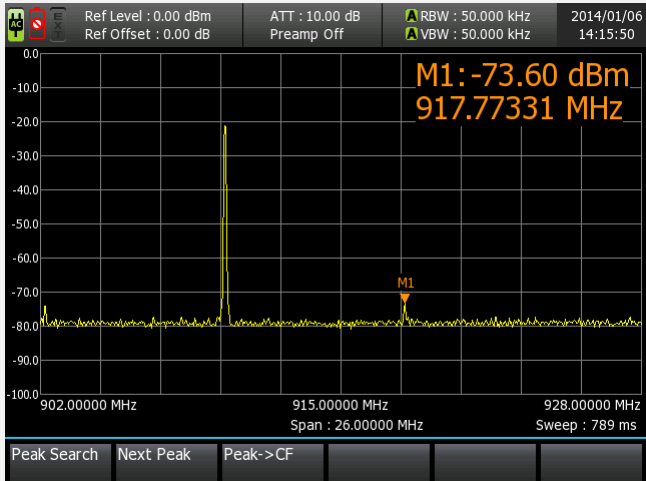

### After Next Peak(F2)

- Moves the marker to the point of which amplitude is next highest on the screen.
- Several traces are set on the screen, sets on the current trace.

## 4.7.3 Peak→CF(F3)

The Peak→CF(F3) is to change the peak point to the center frequency and to set the marker on the point. As the frequency setting is changed, Max Hold or Average should be set again. The following figures show Peak→CF(F3).

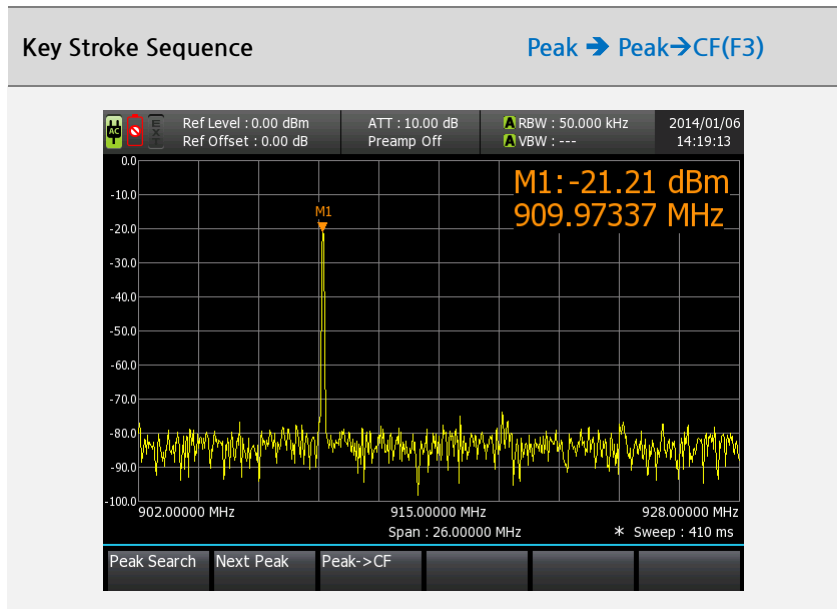

### Before Peak→CF(F3)

- Before Peak→CF(F3)

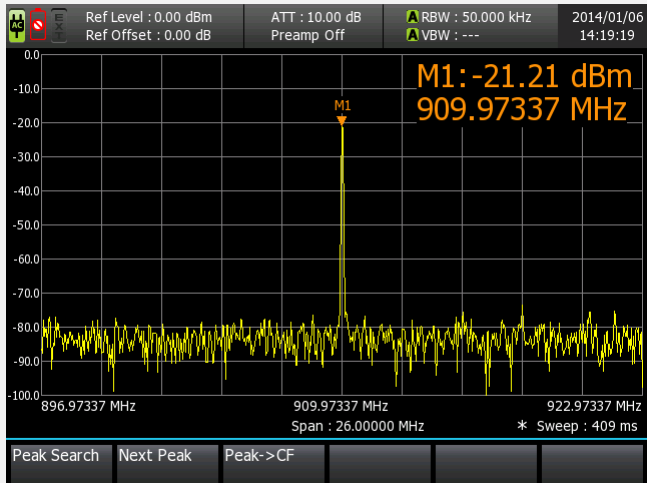

### After Peak→CF(F3)

- Moves the highest amplitude point to the center frequency and then sets the marker on the peak point.

## 4.8 Meas (Measure)

A734 provides useful measurement functions. You can view and select the functions by pressing the Meas key. The following figure shows the location of the Meas key.



Figure 4-26 Measure Control Key

The Meas menu consists of Measure Off(F1), Ch Power(F2), ACP(F3), Harmonic(F4), Phase Noise(F5), Demod(F1) and Pwr Sensor(F2). When pressing the Meas key, the bottom menu F1 ~ F6 are changed to the measure items. Ch Power(F2), ACP(F3), Demod(F1) and Pwr Sensor(F2) have the sub menu as shown in the following figure. The following table shows functions of each item.

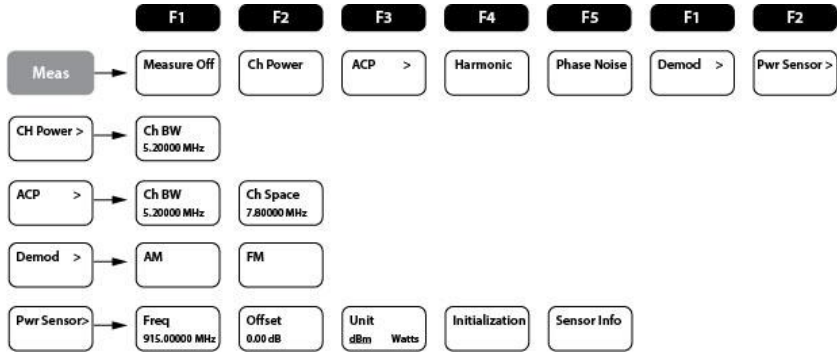

Figure 4-27 Measure Menu-tree

Table 4-40 Measure Menu Descriptions

Name	Select	Description
Measure Off(F1)		- Turns off the measure function.
Ch Power(F2)		- Measures the channel power of the bandwidth.
ACP(F3)		- Measures the ACP with the bandwidth and channel space.
Harmonic(F4)		- Measures the 2 <sup>nd</sup> harmonic by using the 100 kHz signal adjacent to the center frequency as a carrier.
Phase Noise(F5)		- Measures the phase noise with the conditions.
Demod(F1)		- Executes AM/FM demodulation adjacent to the center frequency.
Pwr Sensor(F2)		- Measures the power by using the Power Sensor.

## 4.8.1 Measure Off(F1)

The Measure Off(F1) removes the measurement functions which have been set. If Ch Power(F2), ACP(F3), Harmonic(F4), Phase Noise(F5), Demod(F1) and Pwr Sensor(F2) are set and you want to release the functions, press Measure Off(F1) to remove all functions. The following figure shows execution of the Measure Off(F1).

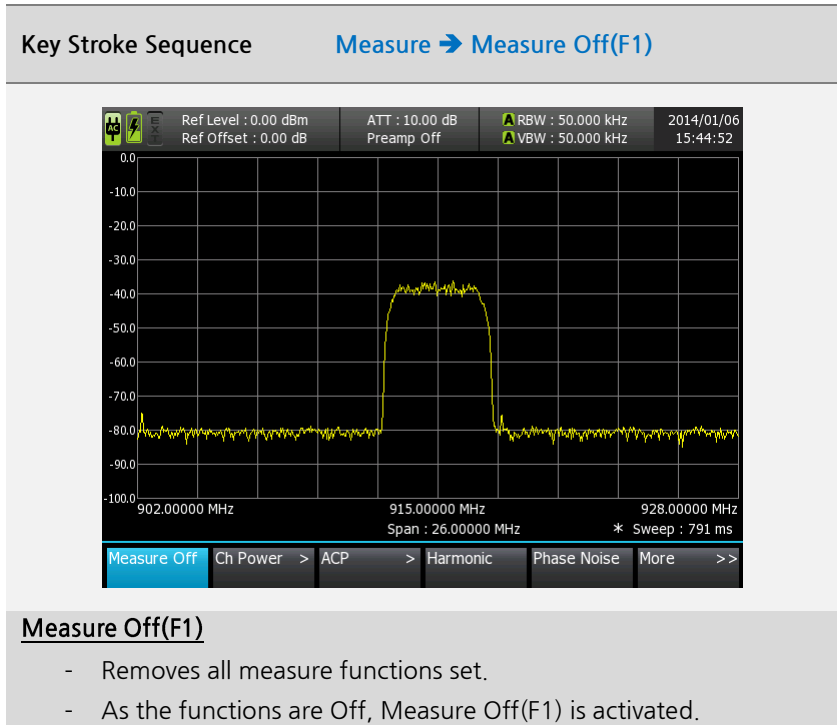

### Measure Off(F1)

- Removes all measure functions set.
- As the functions are Off, Measure Off(F1) is activated.



## 4.8.2 Ch Power(F2)

The Ch Power(F2) measures the power of the modulated signal. After setting the frequency defined in several communication standards and the channel bandwidth and then providing signals, the measured result is displayed. When the Ch Power(F2) is executed, the channel power is measured with the default setting and the bottom menu is changed to the channel power items. As shown in the following figure, the Ch BW(F1) is displayed to change the channel bandwidth.



Figure 4-28 Channel Power Menu-tree

The following figures shows execution of the Ch Power(F2) and the Ch BW(F1) input window.

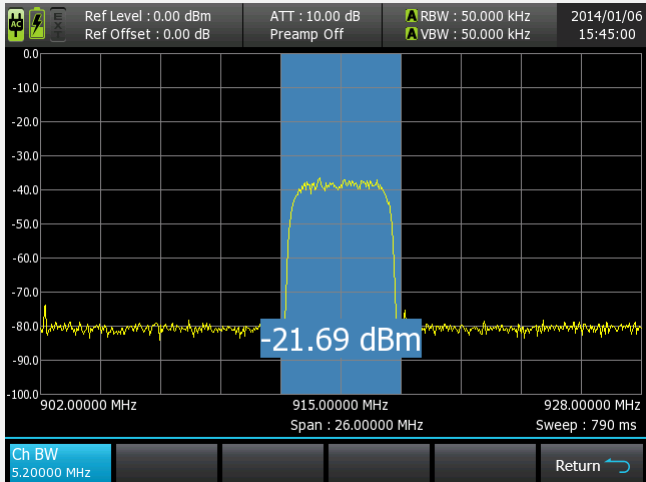

### Ch Power(F2)

- Execute Ch Power(F2) to measure the channel power with the default (Span/5) channel bandwidth.
- You should change the channel bandwidth to the desired value.

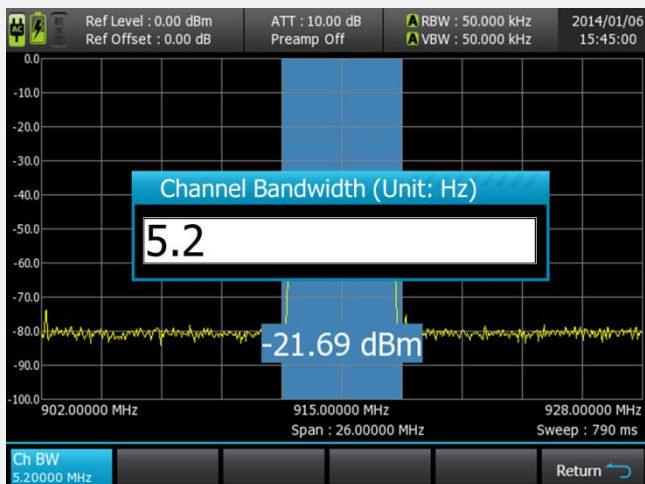

### Ch BW(F1) Input Window

- While Ch BW(F1) is activated, press the number key to display the input window.
- Enter the channel bandwidth and then press the Unit key or the Enter key.
- To close the window without saving the setting, press the ESC key.

Different from the Normal screen, the channel bandwidth is colored in blue in the Channel Power mode and the channel power of the area is displayed at the bottom. The following figure shows the brief description of the Channel Power mode.

## Channel power mode window description

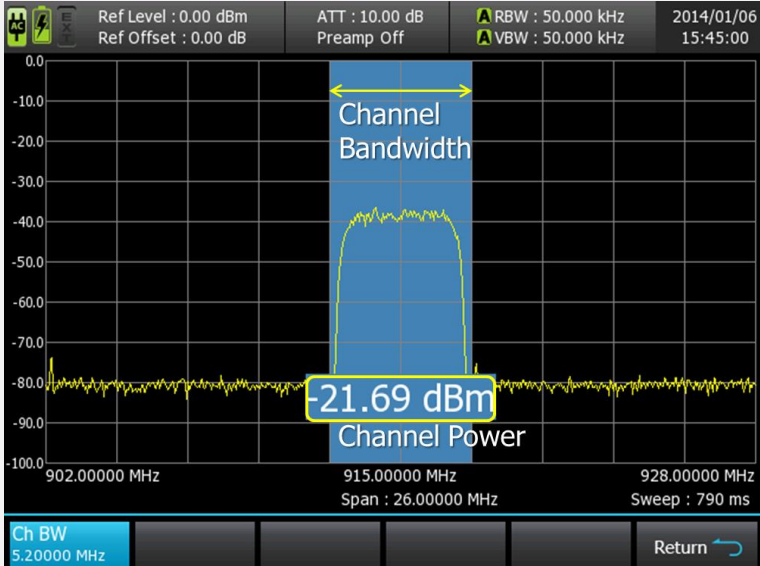

### Notice

Basically, the Detector should be set to Average-Power in the Ch Power(F2) mode. If the Detector is set to Sample, VBW is not applied. So the swing width gets larger and the accuracy gets lower. Causing the power measurement result lower by about 3 dB than the result when the VBW is set. Therefore, the Detector should be set to Average-Power when measuring the channel power or ACP.



### Notice

If the Ch BW(F1) is set larger than the span, a short message saying that it cannot be applied is displayed.



### 4.8.3 ACP(F3)

The ACP(F2) measures the Adjacent Channel Power (ACP) of the modulated signal. After setting the frequency defined in several communication standards and the channel bandwidth, you can view the signal ratio of the carrier channel and the adjacent channel. When executing the ACP(F3), the ACP is measured with the default setting and the bottom menu is changed to the ACP items.



Figure 4-29 ACP Menu-tree

The Ch BW(F1) changes the channel bandwidth and the Ch Space(F2) adjusts the channel space. The following figures show execution of ACP(F3) and the input windows of Ch BW(F1) and Ch Space(F2).

Key Stroke Sequence Measure → ACP(F3)

---

Frequency (MHz)	Power (dBm)	Relative Power (dBc)
902.00000	-62.58	-41.13
915.00000	-21.44	-
928.00000	-62.43	-40.98

Ch BW: 5.20000 Mhz | Ch Space: 7.80000 Mhz | Return

#### ACP(F3) Measurement

- Execute ACP(F3) to measure the channel power with the default channel bandwidth and the default channel space.

- You should change the channel bandwidth and the channel space to the desired values.

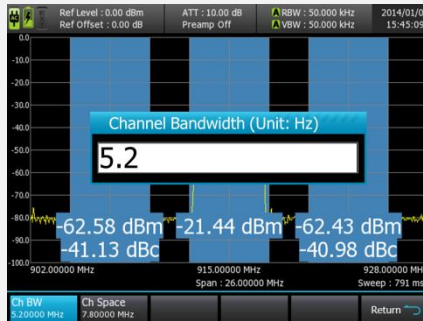

### Ch BW(F1) Input Window

- While Ch BW(F1) is activated, press the number key to display the input window.
- Enter the channel bandwidth and then press the Unit key or the Enter key.
- To close the window without saving the setting, press the ESC key.



### Ch Space(F2) Input Window

- While Ch Space(F2) is activated, press the number key to display the input window.
- Enter the channel space and then press the Unit key or the Enter key.

key.

- To close the window without saving the setting, press the ESC key.

The ACP mode is similar to the Channel Power window. The channel bandwidth and the channel space are colored in blue in the ACP mode and the channel power of the area is displayed at the bottom. The left and right blue areas display the absolute value measured and the power difference from the carrier channel.

### Channel power mode window description

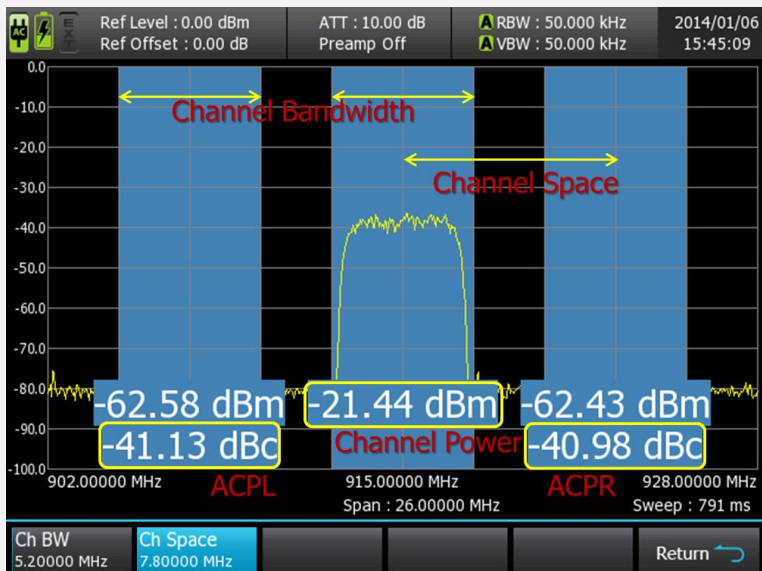

#### Notice

Basically, the Detector should be set to Average-Power in the Ch Power(F2) mode. If the Detector is set to

Sample, VBW is not applied. So the swing width gets larger and the accuracy gets lower. Causing the power measurement result lower by about 3 dB than the result when the VBW is set. Therefore, the Detector should be set to Average-Power when measuring the channel power or ACP.



#### Notice

If the Ch BW(F1) and the Ch Space(F2) are set larger than the span, a short message saying that it cannot be applied is displayed.

## 4.8.4 Harmonic(F4)

The Harmonic(F4) measures the 2<sup>nd</sup> harmonic signal by comparing to the carrier signal at the center frequency. To measure it, move the carrier signal to the center frequency (with Peak→CF) and execute the Harmonic(F4). As shown in the following figure, the left five grids show the carrier signal and the right five grids show the 2<sup>nd</sup> harmonic signal. When executing the Harmonic(F4), markers are set on the carrier signal peak point and the 2<sup>nd</sup> harmonic signal peak point. The marker information is displayed at the bottom and the difference between the carrier signal level and the 2<sup>nd</sup> harmonic signal level is displayed on the right top of the screen.



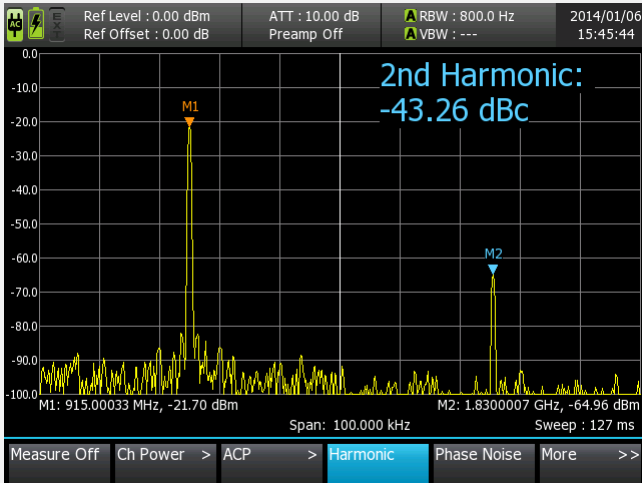

### Harmonic(F4)

- Set the Peak point to the center frequency and then execute Harmonic(F4)
- The left five grids show the carrier signal and the right five grids show the 2<sup>nd</sup> harmonic signal.
- Each marker tracks the peak value. The left top side shows the difference between the carrier peak amplitude and the 2<sup>nd</sup> harmonic peak amplitude.



#### Notice

Peak→CF should be executed before executing the Harmonic(F4). Otherwise, a short message is displayed.



#### Notice

When the Harmonic(F4) is executed, the span is always changed to 100 kHz. The span is 100 kHz even when the Harmonic(F4) is released by the Measure Off(F1).

## 4.8.5 Phase Noise(F5)

The Phase Noise(F5) measures the phase noise characteristics of the signal measured. To measure it, the conditions should be set as follows.

- Trace 1 Clear Write & Average Off
- Span  $\leq$  10kHz
- $| \text{Ref.Level} - \text{Peak Level} | \leq 10\text{dB}$  (Ref.Level control)
- Peak to Center frequency

After setting the conditions as shown above, execute the Phase Noise(F5) and the screen is changed as shown below. If the conditions are not suitable, the Notice window including the above conditions will be displayed, The measurement result from 100 Hz to 100 kHz is displayed and you can check the phase noise of the desired point by setting the marker..

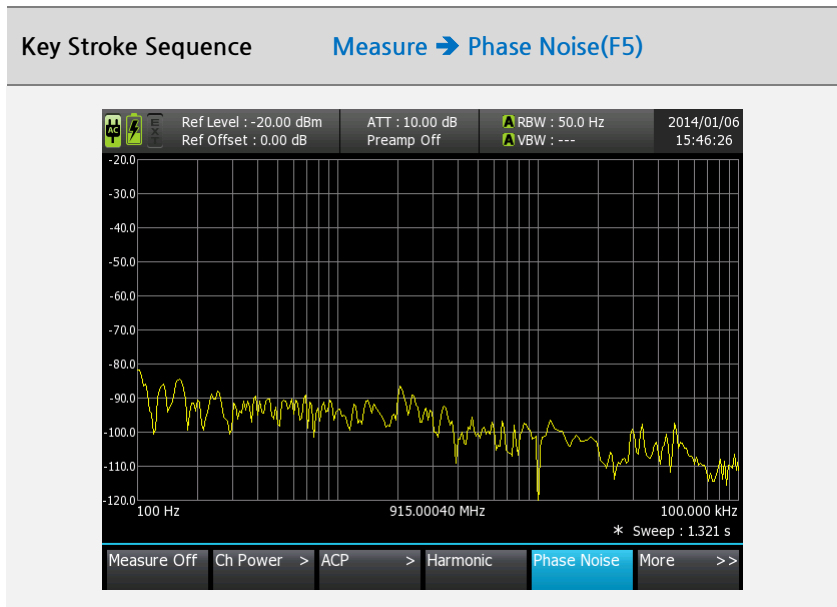

### Phase Noise(F5) Execution

- Execute Phase Noise(F5) after setting the conditions as follows.
- Trace 1 Clear Write & Average Off
- Span  $\leq$  10kHz
- | Ref.Level - Peak Level |  $\leq$  10dB (Ref.Level control)
- Peak to Center frequency
- Displays the result of measuring 100 Hz ~ 100 kHz phase noise.

#### Notice

When executing Phase Noise(F5), the Notice window for the conditions is displayed. Close the window by using the ESC key or the Enter key and set the conditions correctly. IF the conditions are not suitable, the window will appear again.

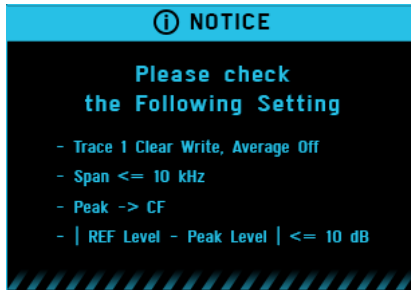

## 4.8.6 Demod(F1)

The Demod(F1) demodulates the signal adjacent to the marker or the center frequency. The modulation types which allow demodulation are AM and FM. The Demod(F1) consists of the sub menus of AM(F1) and FM(F2) as shown below. When the Demod(F1) is executed with the default setting, the FM(F2) is executed. To execute AM demodulation, press the AM(F1).



Figure 4-30 Demodulation Menu-tree

When executing AM(F1) and FM(F2) and a marker is Off as shown in the following figure., the marker is on the center frequency and the marker information on the right top shows the demodulation type and the frequency. When the ear-jack terminal is open, the sound is output through the speaker. When an earphone is connected, the sound is output through the earphone. When changing the frequency, press the Return(F6) to move the bottom menu to the upper layer and then change the frequency. After setting the frequency, press the Demod(F1) again to execute demodulation.

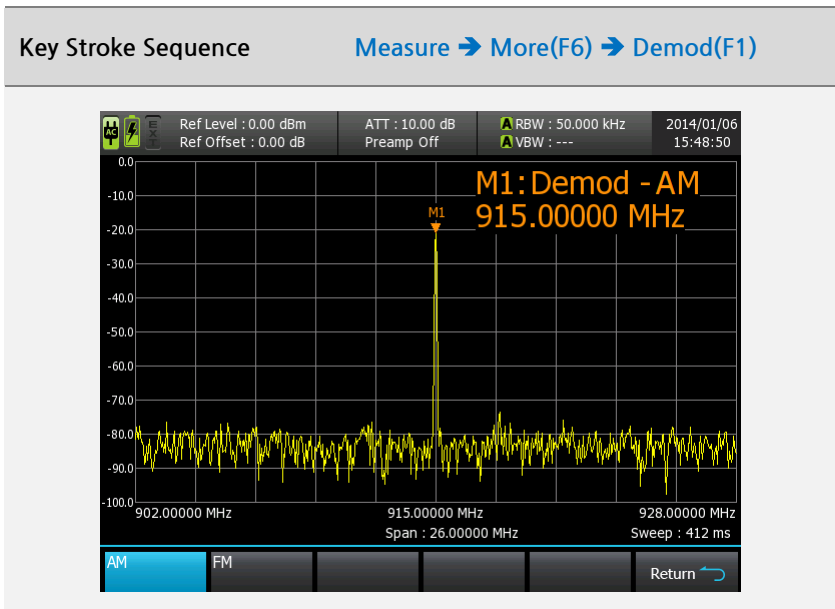

## AM(F1)

- Before executing Demod(F1), place the marker on the frequency which requires demodulation or on the center frequency.
- After setting the frequency, execute the Demod(F1). The FM(F2) is set by default. Press the AM(F1) and then AM demodulation is executed and sound is output from the speaker (or earphone).

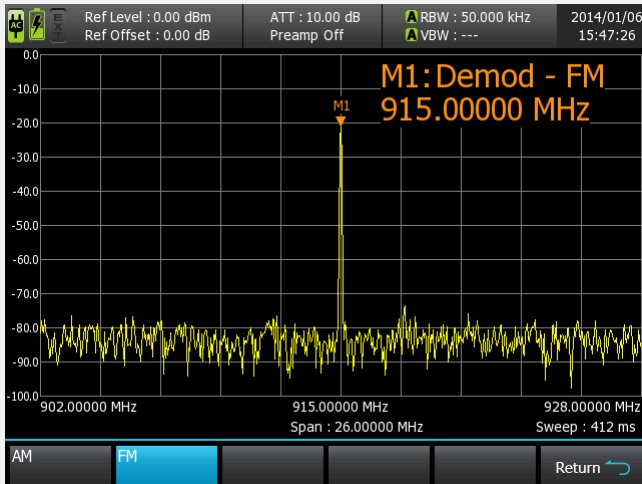

## FM(F2)

- Before executing Demod(F1), place the marker on the frequency which requires demodulation or on the center frequency.
- After setting the frequency, execute the Demod(F1). The FM(F2) is set by default. Press the AM(F1) and then AM demodulation is executed and sound is output from the speaker (or earphone).

### Notice



If you change the frequency while executing demodulation, you should move to the upper menu, change the frequency, and then execute demodulation again.

- Return(F6) click
- Marker or Center frequency change
- Demod(F1) click
- Select AM(F1) or FM(F2)



**Notice**

In the demodulation status, the volume is adjusted by using the Up/Down key or the rotary knob. The volume level is 5-level.

### 4.8.7 Pwr Sensor(F2)

Pwr Sensor(F2) can be used when it is connected to the Power Sensor (optional). It controls and displays the sensor and the measurement result. The sub menus of Pwr Sensor(F2) are Freq(F1), Offset(F2), Unit(F3), Initialization(F4) and Sensor Info(F5).

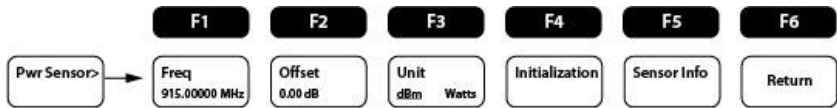

Figure 4-31 Power Sensor Menu-tree

The following table shows each function of the Pwr Sensor(F2) sub menus.

Table 4-41 Power Sensor Menu Descriptions

Name	Select	Description
Freq(F1)		- Sets the frequency of the Power Sensor
Offset(F2)		- Sets the amplitude offset of the

Power Sensor		
Unit(F3)	dBm, Watts	- Sets the measurement unit
Initialization(F4)		- Power Sensor initialization
Sensor Info (F5)		- Power Sensor information display

### Notice

When the Pwr Sensor(F2) is executed while the Power Sensor is not connected, the following Notice window appears. To close it, press the ESC key or the Enter key.

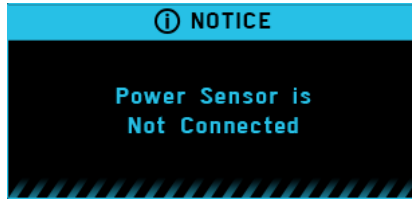

After connecting the power sensor successfully, execute the Pwr Sensor(F2) and then the screen is changed as shown below.

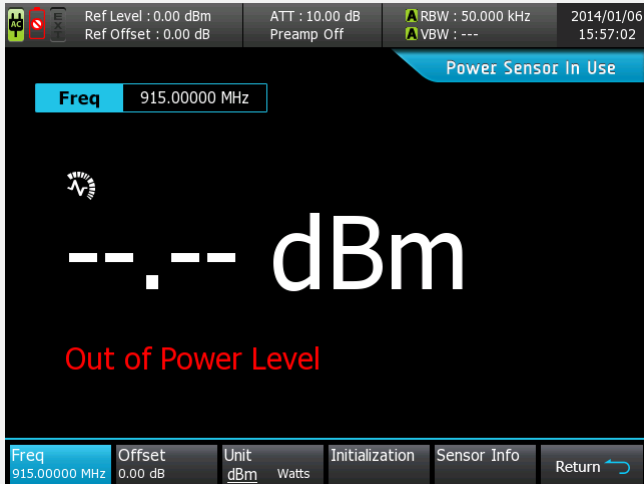

### Pwr Sensor(F2)

- Screen when execution is successful.
- The Power Sensor input port is open, no measurement result exists.
- The measurement range is from +10dBm to -40dBm. The result out of the range is displayed as --.--dBm.

The following figure describes each part of the Pwr Sensor(F2) screen.



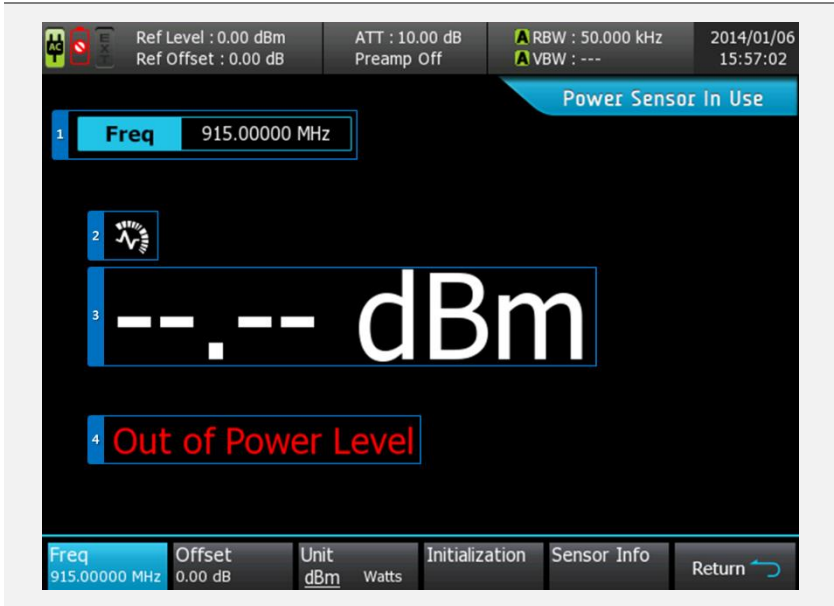

1	Freq	Displays the frequency set
2	Indicator	Indicates the normal operation. When it blinks, the operation is normal. If not blinking, an error occurs.
3	Level	Displays the measured in the unit.
4	Message	Displays the message for the abnormal status

### Notice



The Power Sensor is connected with A734 via USB. A734 uses the USB type interface with the other modules in the device. Therefore, if the A734 power is turned on/off after the Power Sensor has been connected, an error may occur because of the USB recognition sequence. When rebooting the A734 power, you must disconnect the Power Sensor.



### Notice

When the Power Sensor executes measurement, the A734 function keys do not operate. Therefore, you should control the span or frequency of A734 after the power sensor completes measurement. The information is displayed as a short message.

## 4.8.7.1 Freq(F1)

The Freq(F1) sets the frequency to be measured by the power sensor. When the value is entered, the command is sent to the power sensor. After it is activated, press the number key and then the input window will appear. Enter the frequency in the input window and press the Unit key to complete setting.

Key Stroke Sequence Measure → More(F6) → Pwr Sensor(F2) → Freq(F1)

Ref Level : 0.00 dBm	ATT : 10.00 dB	RBW : 50.000 kHz	2014/01/06
Ref Offset : 0.00 dB	Preamp Off	VBW : ---	15:57:26

**Freq** 915.00000 MHz

**-20.38 dBm**

Power Sensor In Use

Freq	Offset	Unit	Initialization	Sensor Info	Return
915.00000 MHz	0.00 dB	dBm	Watts		

## Freq(F1) Activated

- When Pwr Sensor(F2) is executed, Freq(F1) is activated by default.

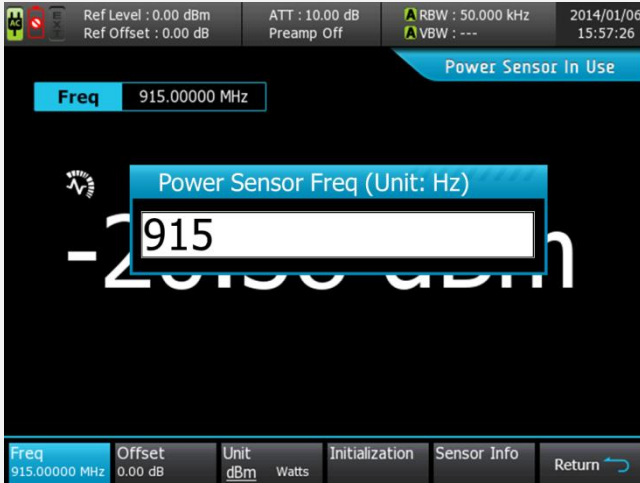

## Freq(F1) Input Window

- While Freq is activated, press the number key and the input window appears.
- Enter the frequency value and then press the Unit key to complete the setting.
- To close the window without saving the setting, press the ESC key.
- The available frequency range is from 20MHz to 3.8 GHz.



### **Notice**

When the frequency of the Power Sensor is out of the range (20MHz ~ 3.8GHz), a short message indicating the input error is displayed.

### 4.8.7.3 Offset(F2)

The Offset(F2) compensates the loss in the cable between the power sensor and the measured object. The input range is from -50dB to +50dB. When the value is out of the range, a short message is displayed. When Offset is set, the measurement result is compensated with the offset and the power is displayed on the main screen.

Key Stroke Sequence

Measure → More(F6) → Pwr Sensor(F2)  
→ Offset(F2)



#### Before Offset(F2)

- The default setting is 0.00 dB and set the offset by considering the external cable loss.

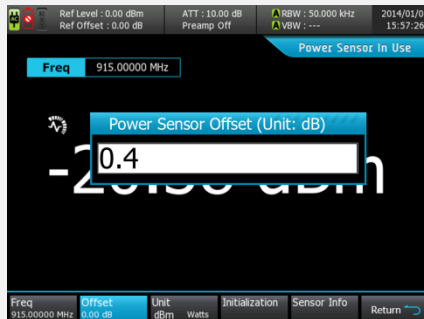

### Offset(F2) Input Window

- While Offset is activated, press the number key and the input window appears.
- Enter the frequency value and then press the Enter key to complete the setting.
- To close the window without saving the setting, press the ESC key.



### After Offset(F2)

- When Offset is set, the result compensated with the offset is displayed on the main screen.

## 4.8.7.4 Unit(F3)

The Power Sensor provides two units to display the measurement result: dBm and Watts. By default, the dBm scale is used. When the unit is changed to the Watts scale, the Watts scale is used. Pressing the Unit(F3) key toggles dBm and Watts.

Key Stroke Sequence

Measure → More(F6) → Pwr Sensor(F2) → Unit(F3)



Unit(F3) dBm Setting

- Power sensor measurement result is displayed in the dBm scale.



### Unit(F3) Watts Setting

- Power sensor measurement result is displayed in the Watts scale.

## 4.8.7.5 Initialization(F4)

It is like A734 Preset. When executed, it is changed to the default setting.



### Notice

Default setting means the frequency and offset are set to initial state.

- Frequency: 1GHz
- Offset: 0.00dB

## 4.8.7.6 Sensor Info(F5)

The Sensor Info(F5) shows the information of connected sensors. It provides the model name, FW version information, serial number, etc.

**Key Stroke Sequence**      Measure → More(F6) → Pwr Sensor(F2) → Sensor Info(F5)

**SYSTEM INFO.**

Model Name : S134  
F/W Version : v0.2.5  
H/W Version : v0.1.4  
Serial Number : 20131025  
Sensor Type : Terminating  
Method Type : Average

Temperature : 29.0 °C

Enter or ESC to Return Menu

Freq    Offset    Unit    Initialization    **Sensor Info**    Return ↻  
915.00000 MHz    0.00 dB    dBm    Watts

### Sensor Info(F5)

- When it is executed, it shows the power sensor information as shown above.
- The Sensor information window is closed by the ESC key or the Enter key.



# 4.9 System

The System provides functions to control items except measurement and sweep. It allows you to save the measured data, the screen or the configuration or to adjust the IP, time or LED brightness. When a new SW is released, it allows you to upgrade it. And you can set either of local or remote through the System menu. The following figure shows the System key location.



Figure 4-32 System Control Key

Press the System key and the bottom menu F1 ~ F6 is changed to the System items. Select each item to change the menu to the related sub menu. The following figure and table show the configuration and functions of the System sub menus. Most of System items have the sub menu and each sub menu controls the system.

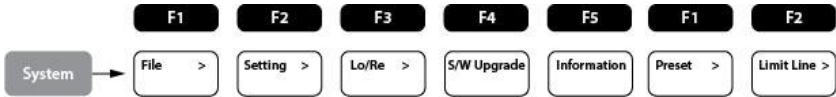
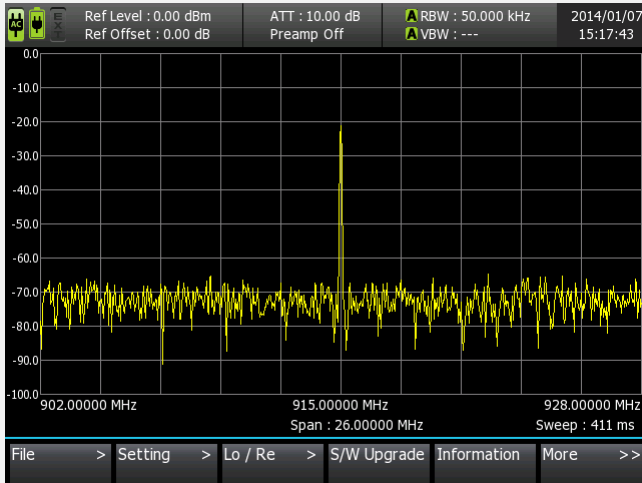

Figure 4-33 System Menu-tree

Table 4-42 System Menu Descriptions

Name	Select	Description
File(F1)		- Sets save, load, file manager, target memory
Setting(F2)		- Sets time, IP, sound, light
Lo/Re(F3)		- Sets either of Local operating or Remote operating
S/W Upgrade(F4)		- Software Upgrade
Information(F5)		- Provides information on A734
Preset(F1)		- Sets the Preset key operation
Limit Line(F2)		- Sets the items related to Limit line



### System menu

- Click the System key to switch the bottom menu as shown above.
- Pressing the F1 ~ F6 keys to move to each sub menu.

## 4.9.1 File(F1)

File(F1) consists of Save(F1), Load(F2), Manager(F3) and Memory(F4). All commands given from File(F1) is executed in the target set by the Memory(F4). If the target is set to USB, the file is saved or loaded in the USB. If it is set to Int, the file is saved or loaded in internal memory. When the USB memory is connected to A734, it takes a little time. The sub menus of File(F1) are shown in the following figure. The following table shows functions of File(F1) sub menus.

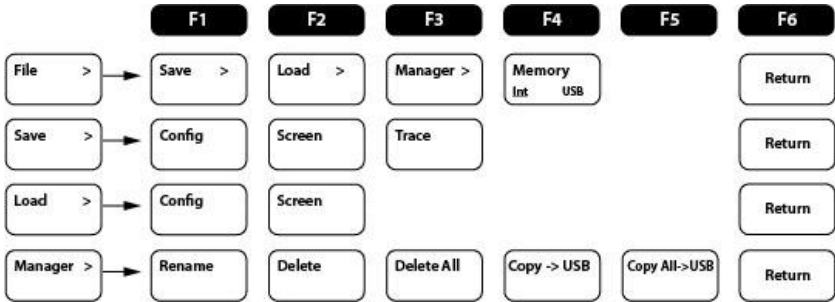
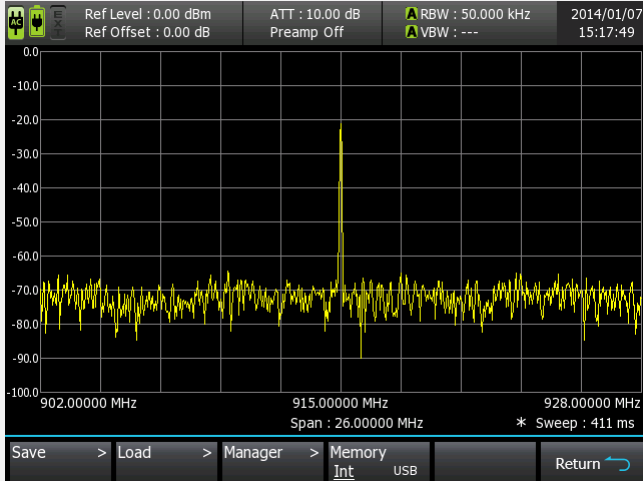

Figure 4-34 File Menu-tree

Table 4-43 File Menu Descriptions

Name	Select	Description
Save(F1)		- Saves the items related to Config, Screen and Trace
Load(F2)		- Loads the Config file and the screen file among the saved (Save(F1)) files
Manager(F3)		- Renames, deletes or copies the saved file
Memory(F4)	Int, USB	- Sets the target memory



### File(F1) menu

- Click the File(F1) and the bottom menu is changed as shown in the above.
- Press the F1 ~ F3 keys to move to each sub menu. Press F4 to set the target.



#### Notice

The max. number of files which can be saved is 150, including Config, Screen and Trace. When it exceeds 150, a short message appears and the file is not saved.



#### Notice

Up to 19 characters are allowed for a file name.

## 4.9.1.1 Save(F1)

The Save(F1) consists of Config(F1), Screen(F2) and Trace(F3). The Config(F1) saves the configuration as a file. The Screen(F2) saves the screen at the time of clicking it. The Trace(F3) saves the trace data at the execution time as a csv file. The following figures show Save(F1) sub menus and execution of Config(F1), Screen(F2) and Trace(F3).

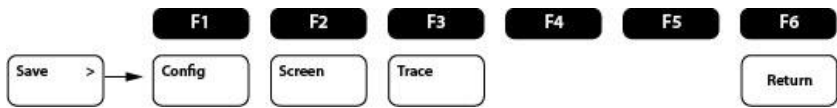
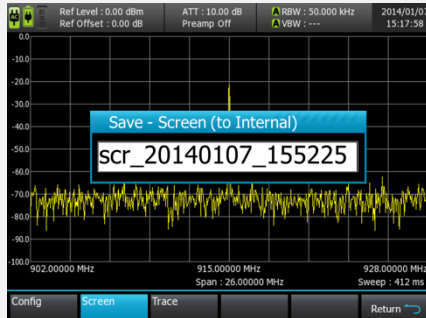

Figure 4-35 Save Menu-tree

**Key Stroke Sequence** System → File(F1) → Save(F1)

**Config(F1) save**

- Press the Config(F1) and the file name input window will appear as shown in the above.
- The default setting is time as shown above, however, you can change it by using the keypad.
- To complete save, press the Enter key. To cancel the setting, press the ESC key.



### Screen(F2) save

- Press the Screen(F2) and the file name input window will appear as shown in the above.
- The default setting is time as shown above, however, you can change it by using the keypad.
- To complete save, press the Enter key. To cancel the setting, press the ESC key.

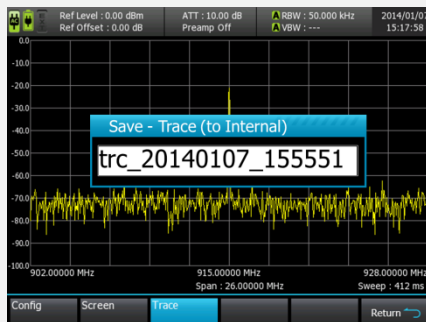

### Trace(F3) save

- Press the Trace(F3) and the file name input window will appear as shown in the above.
- The default setting is time as shown above, however, you can change it by using the keypad.
- To complete save, press the Enter key. To cancel the setting,





## Config(F1) load

- Press the Config(F1) and the configuration file saved in the target memory is displayed.
- Select a file to load by using the Up/Down keys or the rotary knob and then press the Enter key.
- To cancel the setting, press the ESC key.

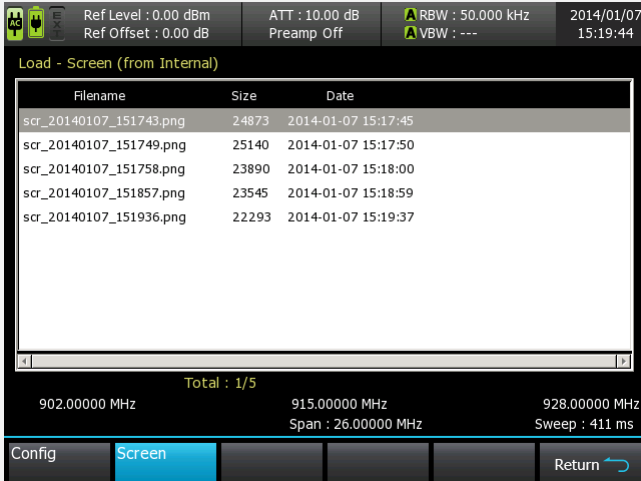

## Screen(F2) load

- Press the Screen(F2) and the screen capture file saved in the target memory is displayed.
- Select a file to load by using the Up/Down keys or the rotary knob and then press the Enter key.
- To cancel the setting, press the ESC key.



### Notice

When the screen capture file is loaded, 'Press ESC key to exit...' blinks on the left top of the screen. Press the ESC key and the loaded screen capture screen disappears and the sweep trace is displayed.

### 4.9.1.3 Manager(F3)

The Manager(F3) consists of Rename(F1), Delete(F2), Delete All(F3), Copy→USB(F4) and CopyAll→USB(F5). Press the Manager(F3) key to open the file manager window. In this window, select the file to rename, delete or copy by using the Up/Down keys or the rotary knob and then click the F1 ~ F5 keys to execute the menu.

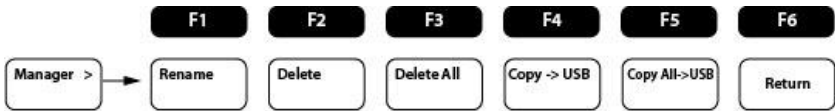

Figure 4-37 Manager Menu-tree

Table 4-44 Manager Menu Descriptions

Name	Select	Description
Rename(F1)		- Renames the Config, Screen or Trace file.
Delete(F2)		- Deletes the selected file.
Delete All(F3)		- Deletes all saved files.
Copy→USB(F4)		- Copies the selected file to the USB.
CopyAll→USB(F5)		- Copies all saved files to the USB.



#### Caution

When executing Delete(F2) or Delete All(F3) after selecting the file, the following warning message is displayed. At this time, when pressing the Enter key, the file is deleted. When pressing the ESC key, the file is not deleted and the warning window is closed.



When executing Delete(F2), Delete All(F3), Copy→USB(F4) or CopyAll→USB(F5) after selecting the file from the file manager window, it is executed after a short message or a warning window is displayed. When executing Rename(F1), the following file rename window appears.

**Key Stroke Sequence**      System → File(F1) → Manager(F3) → Rename(F1)

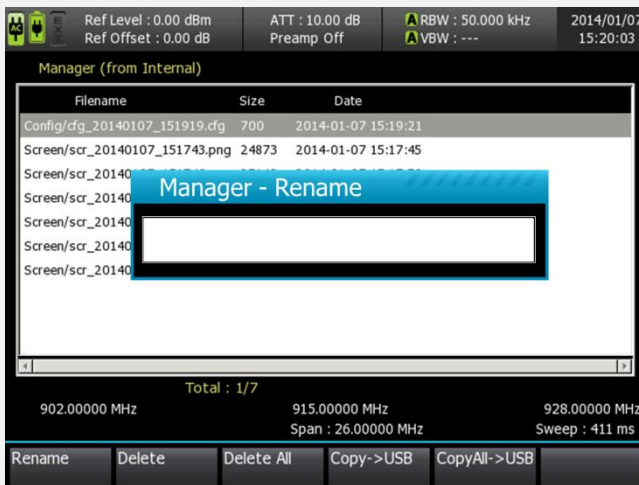

**Rename(F1) File Name Input Window**

- After selecting the file in the file manager window and pressing the Rename(F1), the file rename window appears as shown in the above.
- Enter the file name by using the keypad and then press the Enter key to complete file rename.

- To cancel it, press the ESC key.



### Notice

After completing copy, a short message is displayed. A short message is displayed when the USB has not been connected.

## 4.9.1.4 Memory(F4)

The Memory(F4) sets the system memory target. You can select either of Internal memory and USB memory. Press the F4 key to toggle the target.

### Key Stroke Sequence

System → File(F1) → Memory(F4)

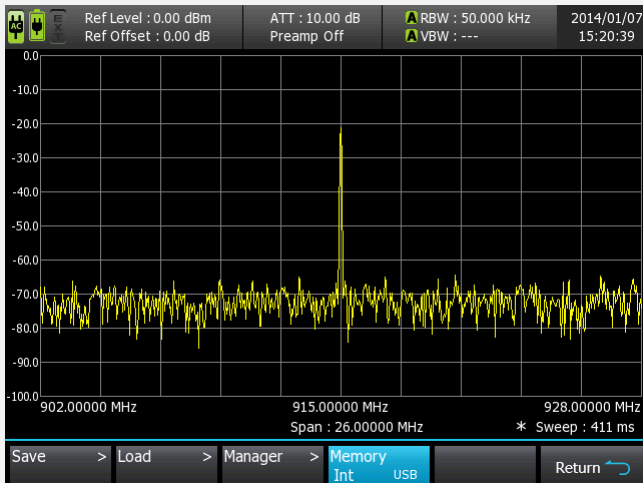

### Int Setting

- The default value is Int and the system memory target is changed according to the Memory(F4) setting.

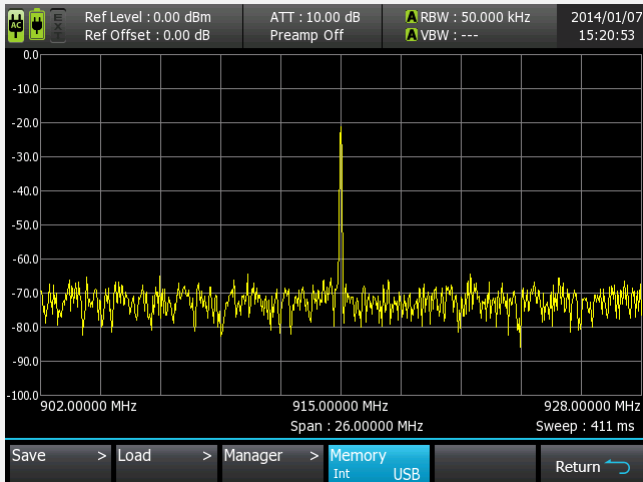

## USB Setting

- After connecting the USB memory, toggle to USB and then the system memory target is changed to USB.

### Notice

When the setting is set to USB without connecting the USB memory, a Notice window is displayed as shown below. Press the Enter key or the ESC key to close the window.



If there is the same file name with the file name you want to save in the USB memory, the file will be overwritten. Please be careful with the file name.

## 4.9.2 Setting(F2)

The Setting(F2) sets or controls additional items of the equipment. Date/Time(F1) is used to set the time. Sleep Time(F2) is used to set the sleep mode entry time. LCD Bright(F3) and Key Light(F4) are used to control the screen brightness and key LEDs. IP Set(F5) is used to set the equipment IP. Sound(F1) is used to control the equipment volume and to control the key beep. The following figure and table show the sub menus of Setting(F2).

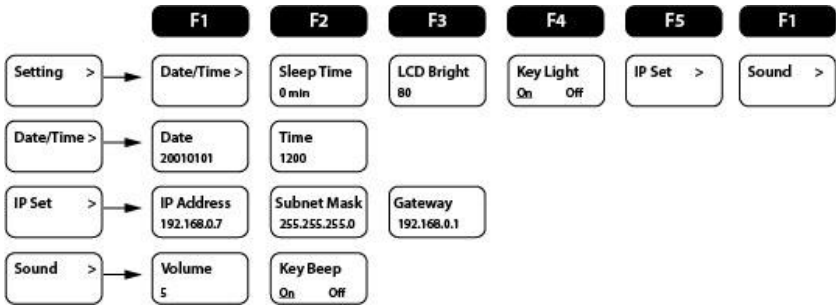
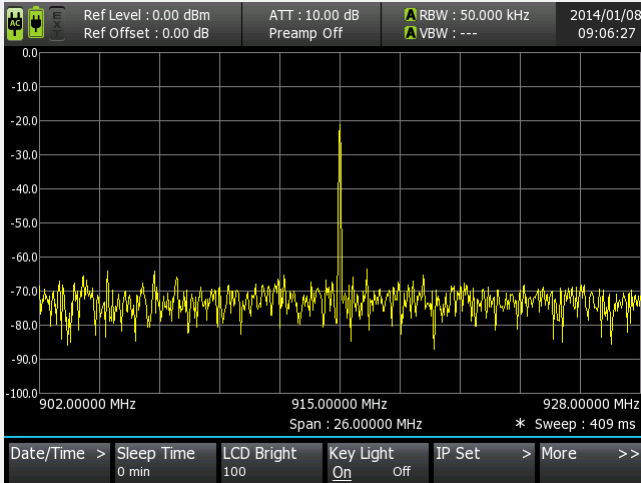

Figure 4-38 Setting Menu-tree

Table 4-45 Setting Menu Descriptions

Name	Select/Range	Description
Date/Time(F1)		- Sets the system date/time.
Sleep Time(F2)	0 - 255	- Sets the sleep mode entry time (Unit: min).
LCD Bright(F3)	0 - 100	- Adjusts the LCD brightness.
Key Light(F4)	On, Off	- Controls the keypad LED.
IP Set(F5)		- Sets the system IP.
Sound(F1)		- Controls the system volume and key beep.



### Setting(F2) menu

- Click Setting(F2) and the bottom menu is switched as shown in the above.
- Press F1 ~ F5 key to move or control to each sub menu.
- Sound(F1) is shown by pressing the More(F6).

## 4.9.2.1 Date/Time(F1)

The Date/Time(F1) sets the date and time of the equipment.

Date/Time(F1) consists of Date(F1) and Time(F2). Date(F1) is used to set the date and the value should be entered in the order of year, month and date without any space. If the number is not the 8-digit number which does not matches the format or range, it is not set. Time(F) is used to set the time and the input should be in the order of hours and minutes. Like Date(F1), if the number is not the 4-digit number which does not matches

the format or range, it is not set. Date/Time(F1) menu and functions are as follows.

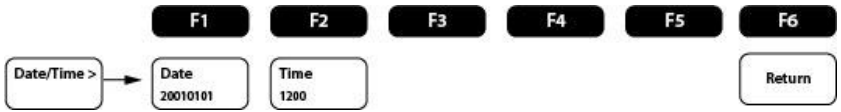

Figure 4-39 Date/Time Menu-tree

Table 4-46 Date & Time Menu Descriptions

Name	Select/Range	Description
Date(F1)	8 digit	- Sets the system date
Time(F2)	4 digit	- Sets the system time

**Key Stroke Sequence**      System → Setting(F2) → Date/Time(F1)

**Date(F1) Setting**

- Press the Date(F1) and then the number key to display the date



input window.

- Enter the year, month and date in the window and then press the Enter key to complete the setting.
- To cancel the setting, press the ESC key.

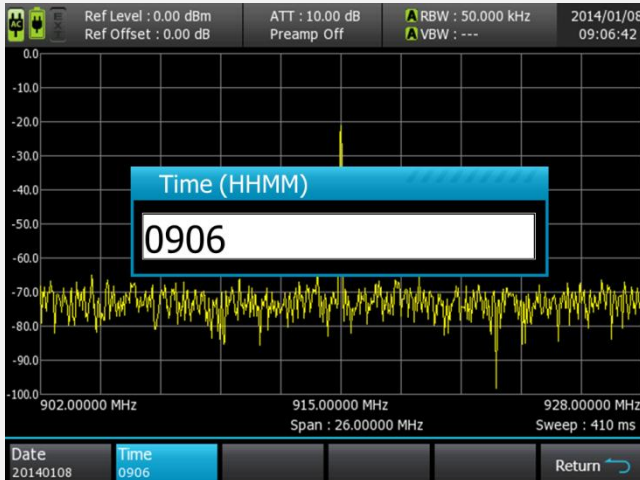

### Time(F2) Setting

- Press the Time(F2) and then the number key to display the time input window.
- Enter the hour and minute in the window and then press the Enter key to complete the setting.
- To cancel the setting, press the ESC key.

### Notice



In the Date(F1) input window, the input format should be `yyyymmdd` without any space. In the Time(F2) input window, the input format should be `hhmm` without any space. If there is any space between digits or if the date or time does not exist, a short error message is displayed.

## 4.9.2.2 Sleep Time(F2)

The Sleep Time(F2) sets the time that the equipment enters into the sleep mode. The Sleep mode is generally used to save the battery power. A734 minimizes or turns off LCD, keypad LED, system clock and sweep in the Sleep mode to minimize the power consumption. If the Sleep mode is not necessary, set Sleep Time(F2) to 0. If the Sleep mode is necessary, set Sleep Time(F2) to the time within the range of 1 ~ 255. Here, the time unit is minute. The following figures show how to set the Sleep Time(F2) and the setting.

### Key Stroke Sequence

System → Setting(F2) → Sleep Time(F2)

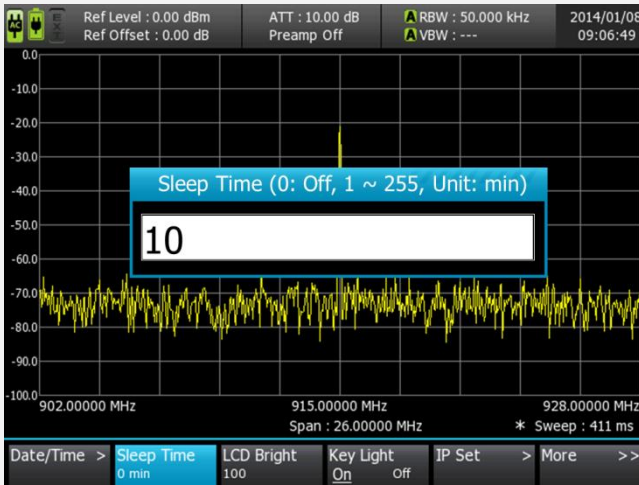

### Sleep Time(F2) Setting

- Press the Sleep Time(F2) and then the number key to display the date input window.
- Enter one value from 0 ~ 255 and then press the Enter key to complete the setting.
- To cancel the setting, press the ESC key.

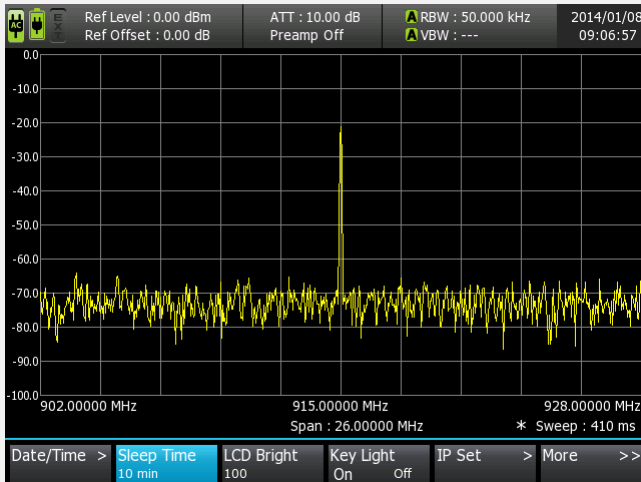

### Sleep Time(F2) Operation

- If 10 minutes is set as shown in the above and the user does not operate the equipment for 10 minutes, A734 enters into the Sleep mode.
- In the Sleep mode, A734 stops LCD, Key pad LED, System clock and Sweep to save the energy.

#### Notice



When Sleep Time(F2) is set to 0, the Sleep mode is released. When it is set to one of 1 to 255, the Sleep mode is activated according to the time set. If you do not want the Sleep mode, set it to 0.



#### Notice

To release the Sleep mode, press 'ESC' or 'Enter' key.

### 4.9.2.3 LCD Bright(F3)

LCD Bright(F3) adjusts the LCD backlight brightness. It is used to make the screen brighter or darker to reduce the power consumption. The range is 0 ~ 100 and the unit is %. When it is set to 0%, the LCD backlight is the darkest status. 100% indicates the brightest status. The following figures show how to set LCD Bright(F3) and the setting.

**Key Stroke Sequence**      **System → Setting(F2) → LCD Bright(F3)**

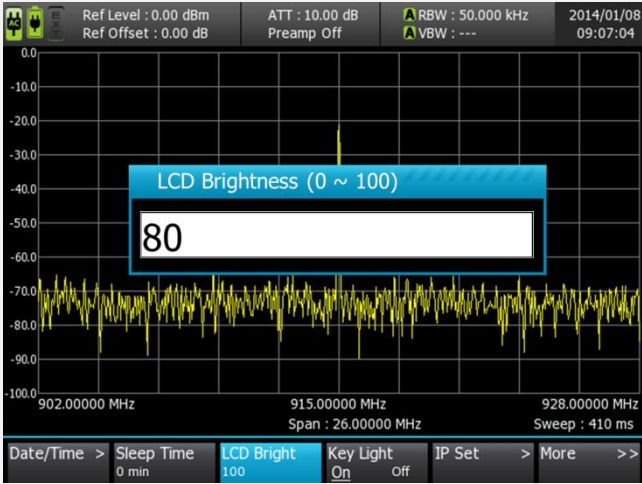

The screenshot displays a spectrum analyzer interface. At the top, there are status indicators: Ref Level : 0.00 dBm, Ref Offset : 0.00 dB, ATT : 10.00 dB, Preamp Off, RBW : 50.000 kHz, VBW : ---, and the date/time 2014/01/08 09:07:04. The main display area shows a spectrum plot with a signal peak at 915.00000 MHz. A blue dialog box is overlaid on the plot, titled "LCD Brightness (0 ~ 100)" and contains a text input field with the value "80". The bottom of the screen features a control panel with buttons for "Date/Time", "Sleep Time" (0 min), "LCD Bright" (100), "Key Light" (On/Off), "JP Set", and "More" (>>).

**LCD Bright(F3) Setting**

- Press the LCD Bright(F3) and then the number key to display the date input window.
- Enter one value from 0 ~ 100 and then press the Enter key to complete the setting.
- To cancel the setting, press the ESC key.

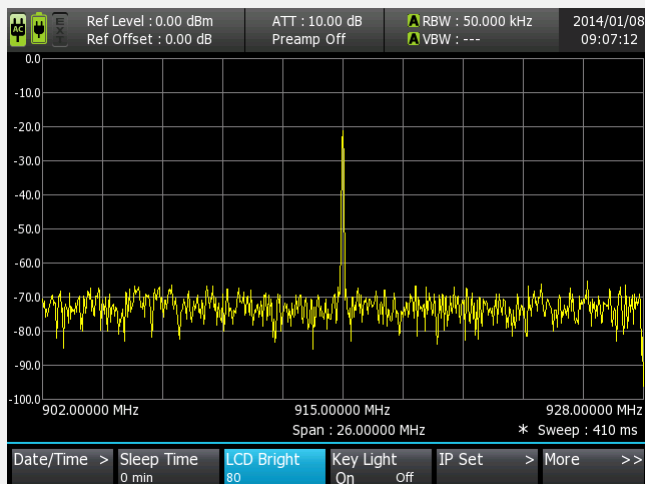

### LCD Bright(F3) Operation

- The above figure shows LCD brightness 80%.
- When the battery is used, LCD brightness can be set to the low value to save the power.

### 4.9.2.4 Key Light(F4)

The Key Light(F4) turns on or off the key pad LED. In the dark place, the key pad silk is not clearly recognized. In this case, set the Key Light(F4) to On to turn on the key pad LED and then the light shines on the silk for easy recognition. If it is not necessary, set it to Off to save the power. The following figures show how to set Key Light(F4) and the setting.

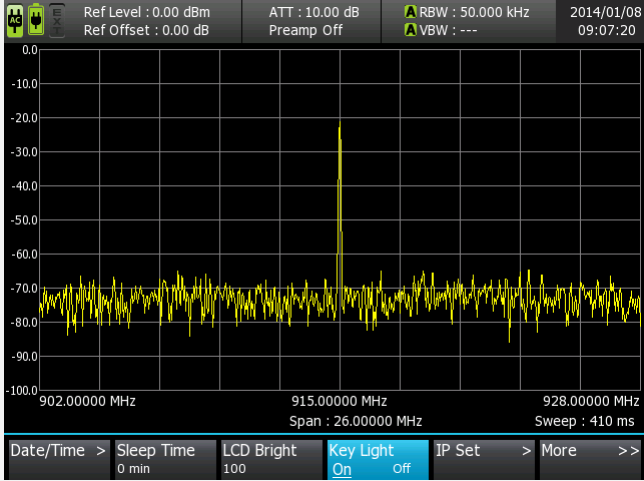

### Key Light(F4) Setting

- The default setting is key light On.
- When it is set to On, the key pad LED is turned on and the key silk is visible in the dark place.

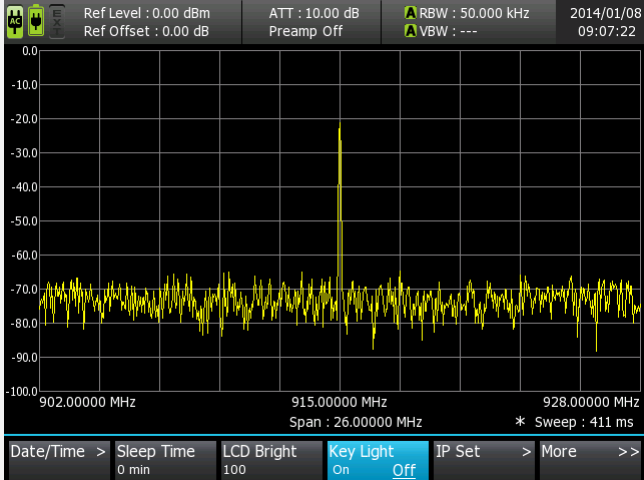

### Key Light(F4) Operation

- Press the Key Light(F4) to switch the status to Off (toggle between On and Off)
- When it is set to Off, the key pad LED is not turned on even when the keys are used.

## 4.9.2.5 IP Set(F5)

The IP Set(F5) sets the equipment IP and it must be set when Ethernet is used to connect to the equipment. Especially, the IP should be identical for remote operation. The IP Set(F5) consists of IP Address(F1), Subnet Mask(F2) and Gateway(F3). The following figure and table show sub menus and functions of IP Set(F5).

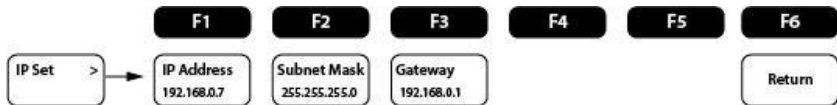
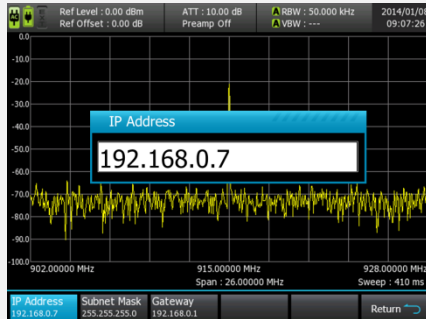

Figure 4-40 IP Set Menu-tree

Table 4-47 IP Set Menu Descriptions

Name	Select/Range	Description
IP Address(F1)		- Sets the system IP address.
Subnet Mask(F2)		- Sets the system subnet mask.
Gateway(F3)		- Sets the system gateway.



### IP Address(F1) Setting

- Press the IP Address(F1) and then the number key to display the input window.
- Enter the value in the IP field and then press the Enter key to complete the setting.
- To cancel the setting, press the ESC key.

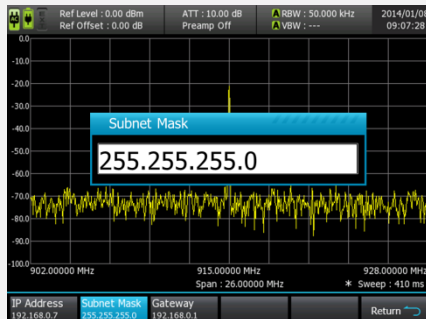

### Subnet Mask(F2) Setting

- Press the Subnet Mask(F2) and then the number key to display the input window.
- Enter the value in the IP field and then press the Enter key to complete the setting.



To cancel the setting, press the ESC key.

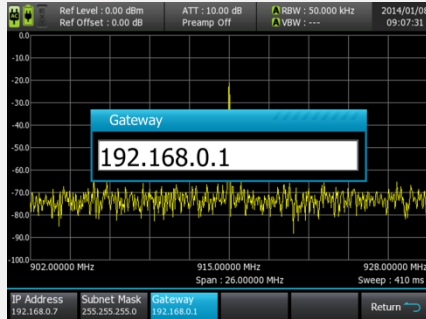

### Gateway(F3) Setting

- Press the Gateway(F3) and then the number key to display the input window.
- Enter the value in the IP field and then press the Enter key to complete the setting.
- To cancel the setting, press the ESC key.

### Notice



IP setting is not required for local operation; however, it must be set for remote operation. Remote operation is available only when the IP setting of A734, the IP setting of the remote PC and the IP setting of the remote program are identical.

## 4.9.2.6 Sound(F1)

The Sound(F1) controls the sound output of the equipment. You can set the overall volume and key beep output. The sub menus are Volume(F1) and Key Beep(F2) and the functions are as follows.



Figure 4-41 Sound Menu-tree

Table 4-48 Sound Menu Descriptions

Name	Select/Range	Description
Volume(F1)	0 - 5	- Sets the system volume. 0 is mute.
Key Beep(F2)	On, Off	- Sets the key beep.

Key Stroke Sequence      [System](#) → [Setting\(F2\)](#) → [More\(F6\)](#) → [Sound\(F1\)](#)

The screenshot shows the Sound menu interface. At the top, there are status indicators: Ref Level: 0.00 dBm, Ref Offset: 0.00 dB, ATT: 10.00 dB, Preamp Off, RBW: 50.000 kHz, VBW: ---, and the date/time 2014/01/08 09:07:42. The main display is a spectrum analyzer with a frequency range from 902.00000 MHz to 928.00000 MHz and a span of 26.00000 MHz. A blue box highlights the 'Sound Volume (0: Mute, 1 ~ 5)' setting, with the value '5' entered in a text field. At the bottom, there are control buttons for 'Volume 5', 'Key Beep On Off', and a 'Return' button with a right arrow.

## Volume(F1) Setting

- Press the Volume(F1) and then the number key to display the input window.
- Enter the value (0 ~ 5) in the volume field and then press the Enter key to complete the setting.
- To cancel the setting, press the ESC key.

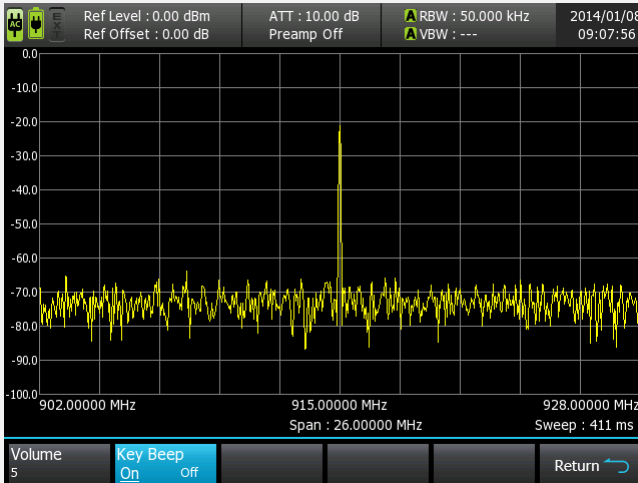

## Key Beep(F2) Setting

- Press the Key Beep(F2) to toggle between On and Off.
- Set it to On to output the beep when pressing the key pad buttons.



### Notice



When an earphone is connected to A734, all sounds including key beep, demodulation and limit line beep are output via the earphone. When the earphone is disconnected, the sound is output through the speaker.

The Volume(F1) can be adjusted by using the Up/Down keys and the rotary knob. The volume is controlled as described in the following table.



Figure 4-42 Volume Control (Up/Down Key & Rotary knob)

Table 4-49 Volume Control (Up/Down Key & Rotary knob)

Item	DitECTION	Description
	Lower	1 push -> The volume decreases by one level.
	Upper	1 push -> The volume increases by one level.
	Lower	1 click -> The volume decreases by one level.









Upper

1 click -> The volume increases by one level.

The volume image is changed according to the level.

Table 4-50 Volume Control Step

0(Mute)	1	2	3	4	5
					

### 4.9.3 Lo/Re(F3)

The Lo/Re(F3) sets local operating and remote operating. The default setting is local and it is for local operation. To operate the equipment remote, the mode should be changed by using the Remote(F2). Before changing the local mode to the remote mode, a warning window appears. At this time, press the Enter key to change the mode. Press the ESC key to keep the previous mode. In the Remote mode, the sweep data is sent to the remote PC and the trace is not displayed on the LCD of the equipment, but just ***Remote Mode*** is displayed. The following table and figure show the Lo/Re(F3) sub menus and functions.

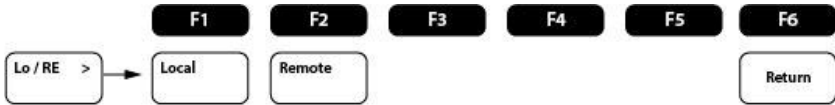

Figure 4-43 Local & Remote Menu-tree

Table 4-51 Lo/Re Menu Descriptions

Name	Select/Range	Description
Local(F1)		- Default setting. Local operating
Remote(F2)		- Remote operating

**Key Stroke Sequence**      System → Lo/Re(F3)

**Local(F1) Setting**

- Default setting, normal operation



### Remote(F2) Setting

- Operation interworking with the remote GUI
- The LCD displays Remote Mode and all keys except the F1 key and the Power key cannot be operated.

### Caution

When switching between Remote and Local, the following warning window appears. Enter the Enter key to complete switch, or press the ESC key to cancel the setting.



[Local Warning Window]



[Remote Warning Window]



## 4.9.4 SW Upgrade(F4)

The S/W Upgrade(F4) upgrades the equipment S/W when a new firmware is released. Copy the firmware (\*.tar file) downloaded from the web site to the root folder of the USB memory. Connect the USB to the A734 USB terminal and press the S/W Upgrade(F4) to display the upgrade warning window. At this time, press the ESC key to cancel it. To upgrade with the file, press the Enter key. The progress status is displayed in a short message and then the equipment is automatically rebooted. After rebooting, when the upgrade has been successfully completed, the *'FW upgrade OK'* short message is displayed. The following figure shows the warning window displayed after connecting the USB memory.

Key Stroke Sequence      System → S/W Upgrade(F4)



Ref Level : 0.00 dBm      ATT : 10.00 dB      RBW : 50.000 kHz      2013/10/10  
Ref Offset : 0.00 dB      Preamp Off      VBW : ---      15:02:26

0.0  
-10.0  
-20.0  
-30.0  
-40.0  
-50.0  
-60.0  
-70.0  
-80.0  
-90.0  
-100.0

902.00000 MHz      915.00000 MHz      928.00000 MHz  
Span : 26.00000 MHz      Sweep : 413 ms

File > Setting > Lo / Re > **S/W Upgrade** Information More >>

### S/W Upgrade(F4) Setting

- Copy the firmware (\*.tar file) downloaded from the web site to the root folder of the USB memory and then connect the USB memory to the A734 USB terminal.
- Press the S/W Upgrade(F4) to display the upgrade warning



window. At this time, press the Enter key to upgrade with the file.

- The equipment is automatically rebooted. When the upgrade has been successfully completed, a short message shows OK.
- To cancel the upgrade, press the ESC key in the warning window.

### Notice

S/W Upgrade(F4) can be executed only when the USB memory has the firmware. If the USB memory is not connected, the following Notice window appears. If the USB is connected but the upgrade is tried to with invalid file, a short message saying SW upgrade failure is displayed after rebooting.



### Caution

When S/W Upgrade(F4) is executed, the following warning window is displayed. Press the Enter key to start upgrade. A short message displays the upgrade progress. After rebooting, a short message for upgrade is displayed. If the upgrade is successful, the FW Upgrade OK message is displayed.



## 4.9.5 Information(F5)

Press the Information(F5) to view information of the A734 system, such as FW version, configuration, IP setting, external interface status, temperature and other setting information. To close the window, press the Enter or the ESC key. When this window is open, no other function keys can operate. The following figure shows the information window.

**Key Stroke Sequence**      **System → Information(F5)**

**SYSTEM INFO.**

Model Name : A734	AC Power : On
Manufacturer : GS Instruments Co., Ltd.	Battery : 100 %
GUI Version : v0.1.14	LAN Port : Link Down
F/W Version : v0.1.21	USB Memory : Disconnect
Serial Number : InputSerialNum..	
Sleep Time : Off	System Temperature : 43.9 °C
LCD Brightness : 100 %	RF Module Temperature : 47.3 °C
Key Light : On	Battery Temperature : 36.6 °C
	Volume : 5
IP Address : 192.168.0.7	Key Beep : On
Subnet Mask : 255.255.255.0	Preset Load Type: Factory
Default Gateway : 192.168.0.1	

Enter or ESC to Return Menu

File > Setting > Lo / Re > S/W Upgrade > **Information** > More >>

**Information(F5) Check**

- Press the Information(F5) to view the information window.
- View various information from the window.
- To close the window, press the Enter or the ESC key.

### Notice

When the remaining battery capacity is about 10% and 5%, the following notice window is displayed to inform that to the user. When the remaining battery capacity is 1%, the notice window at the right side is displayed and the system is automatically powered off.



[Battery 10% or 5% message]

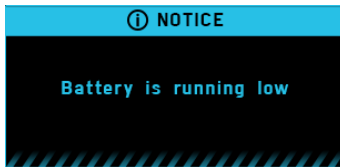

[Battery 1% message]

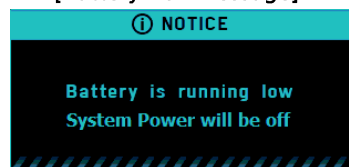

### Notice

A734 displays three temperatures on the information window. When the temperature is abnormally increasing, the corresponding Notice window appears. When the temperature notice window appears, cool down the temperature and then use the system again. If the temperature notice occurs in the normal ambient environment, contact us for maintenance service.





### 4.9.6 Preset(F1)

The Preset(F1) sets the configuration according to the Preset key operation. Basically, the factory preset is provided, but the user-defined configuration can be set as preset. The following figure shows the sub menu and functions of Preset(F1).

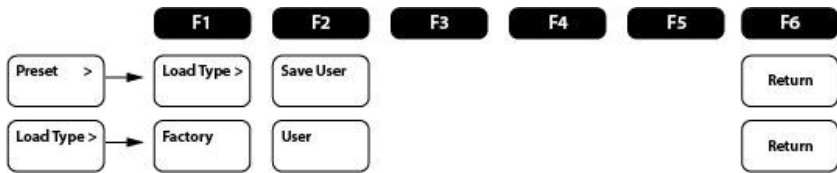

Figure 4-44 Preset Menu-tree

Table 4-52 Preset Menu Descriptions

Name	Select/Range	Description
Load Type(F1)	Factory, User	- Sets the Preset item.
Save User(F2)		- Saves the user preset with the configured conditions.

Key Stroke Sequence

System → More(F6) → Preset(F1)

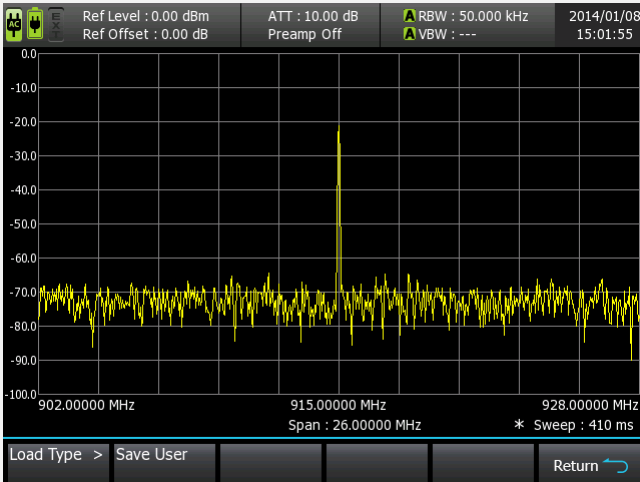

Preset(F1) menu

- Click the Preset(F1) to change the bottom menu as shown in the above figure.

### 4.9.6.1 Load Type(F1)

The Load Type(F1) sets the preset execution conditions according to execution of the Preset key. Basically, factory preset is saved but users can save the conditions as a preset. This is to select either of the user preset and the factory preset. The sub menus are Factory(F1) and User(F2) and either of two must be activated. The following figure and table show the sub menus and functions of Load Type(F1).

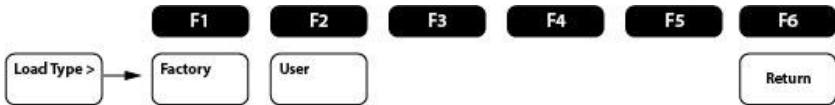

Figure 4-45 Load Type Menu-tree

Table 4-53 Load Type Menu Descriptions

Name	Select/Range	Description
Factory(F1)		- Sets to factory preset
User(F2)		- Sets to user preset

## Key Stroke Sequence

System → More(F6) → Preset(F1) →  
Load Type(F1)

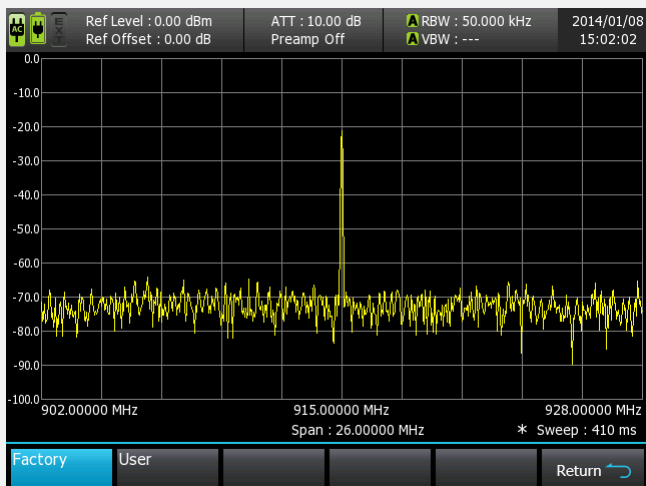

## Factory(F1) Setting

- Sets with the factory preset set by the manufacturer.
- Press the Preset key to set the configuration with the factory preset.

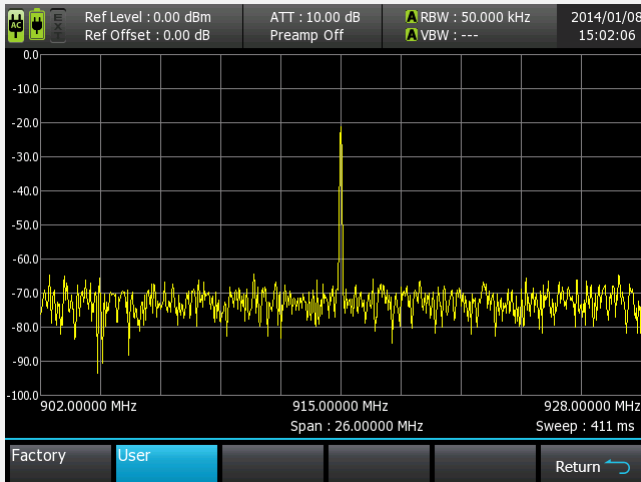

### User(F2) Setting

- Sets with the user-defined configuration.
- Press the Preset key to set the configuration with the user preset.

### 4.9.6.2 Save User(F2)

The Save User(F2) saves the User Preset items. When the user has set the configuration to be applied to the preset and then executes the Save User(F2), the configuration is saved in the User Preset and the preset is executed with the user-defined configuration when pressing the Preset key. The following figure shows the Save User(F2) and a short message is displayed when execution is completed.



## Key Stroke Sequence

System → More(F6) → Preset(F1) →  
Save User(F2)

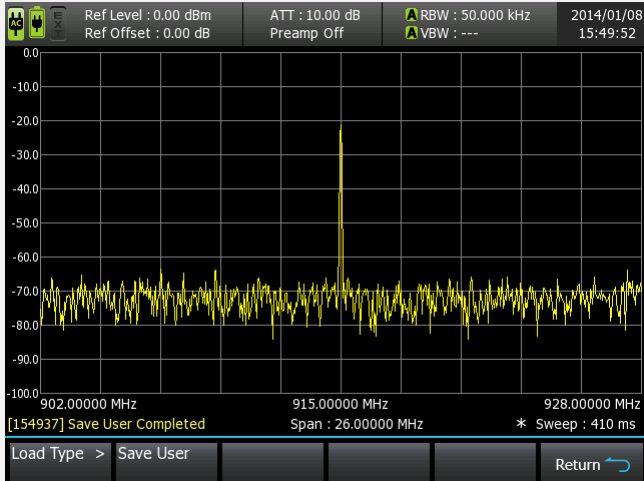

## Save User(F2) Check

- Press the Save User(F2) to save the user preset information with the current configuration.
- After completing save, the short message is displayed as shown in the above.
- The configuration should be set before executing Save User(F2).

## 4.9.7 Limit Line(F2)

The Limit Line(F2) draws a horizontal line on the screen. If the measurement result is larger or smaller than the line, it determines pass or fail of the result and controls the beep based on the determination. The sub menus are Limit Line(F1), Limit Level(F2), Limit Type(F3) and Limit Beep(F4) and the functions are as follows. When the menu is selected, the Limit Level(F2) is automatically activated.



Figure 4-46 Limit Line Menu-tree

Table 4-54 Limit Line Menu Descriptions

Name	Select/Range	Description
Limit Line(F1)	On, Off	- Sets the limit line to On or Off.
Limit Level(F2)	-480-320dBm	- Sets the limit line level.
Limit Type(F3)	Upper, Lower	- Sets the Pass/ Fail conditions.
Limit Beep(F4)	On, Off	- Sets whether to output beep according to the result Pass/Fail.

## Key Stroke Sequence

System → More(F6) → Limit Line(F2)

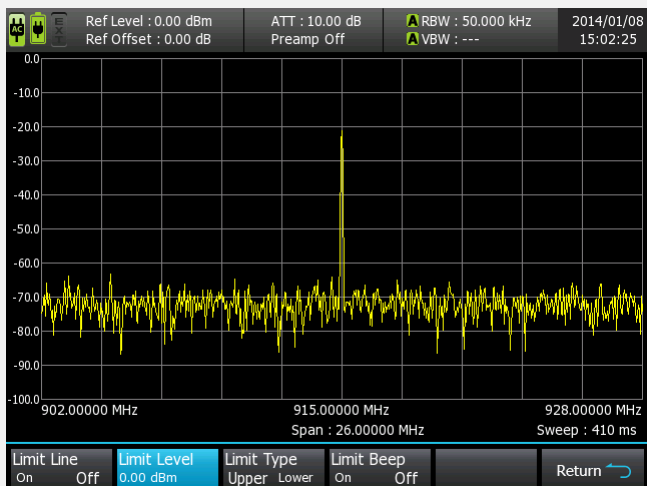

### Limit Line(F2) menu

- Press the Limit Line(F2) to change the bottom menu as shown in the above figure.

## 4.9.7.1 Limit Line(F1)

The Limit Line(F1) controls On/Off. When it is set to On, a red horizontal line is displayed on the screen and Pass or Fail is displayed based on the other conditions. The default setting is Off and there is no horizontal line on the screen. The following figures show the Limit Line(F1) On status and Off status.

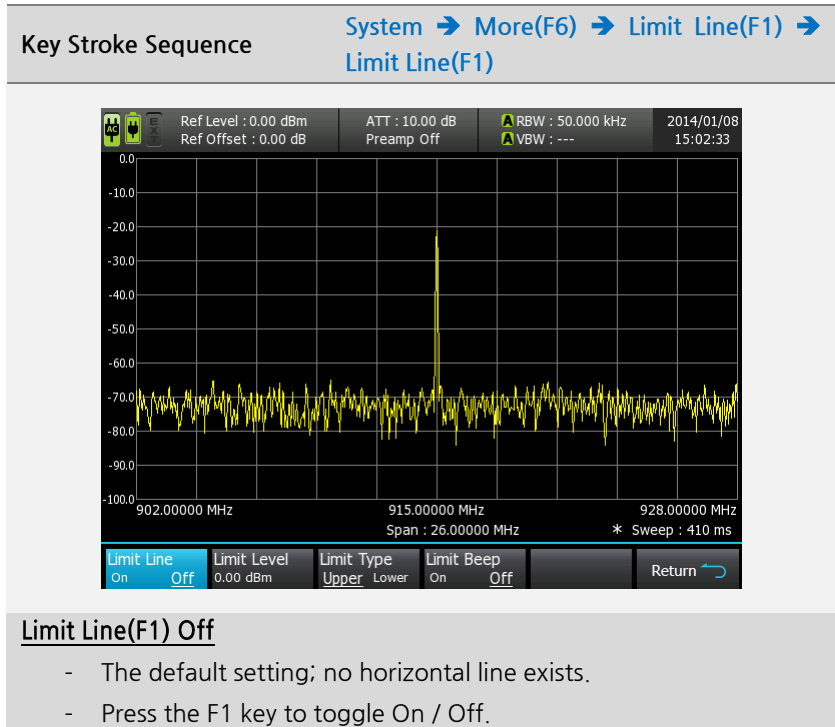

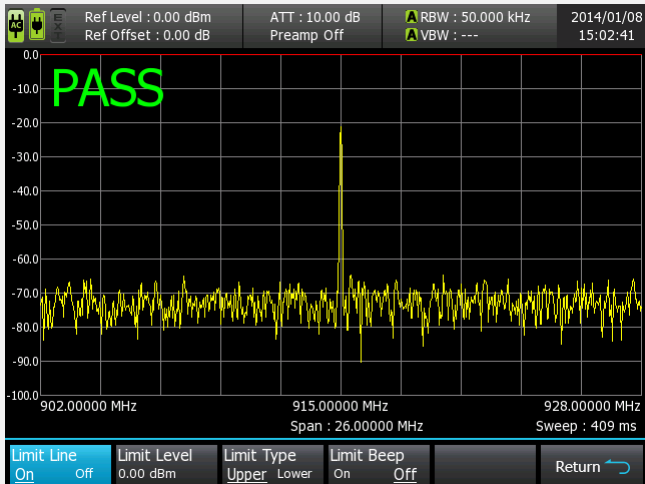

### Limit Line(F1) On

- A red horizontal line is displayed on the screen and Pass or Fail is displayed based on the other conditions.

## 4.9.7.2 Limit Level(F2)

The Limit Level(F2) sets the level of red limit line. The limit line can be moved by using the reference level of the setting value. The available range is from -480 to 320dBm and the number keys, Up/Down keys and rotary knob can be used to enter the value. After completing input, the limit line is moved to the reference level. The following figures shown the limit line moved from the default setting to -10dBm.

Key Stroke Sequence

System → More(F6) → Limit Line(F1) → Limit Level(F2)

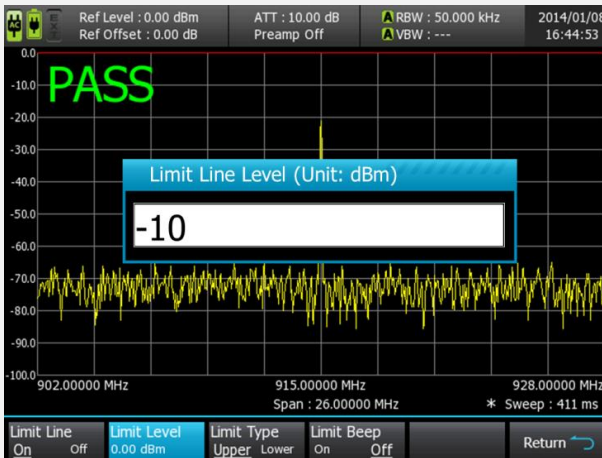

### Limit Level(F2) Input

- Press the Limit Level(F2) and then the number key to display the input window.
- Enter the limit line level in the volume field and then press the Enter key to complete the setting.
- To cancel the setting, press the ESC key.

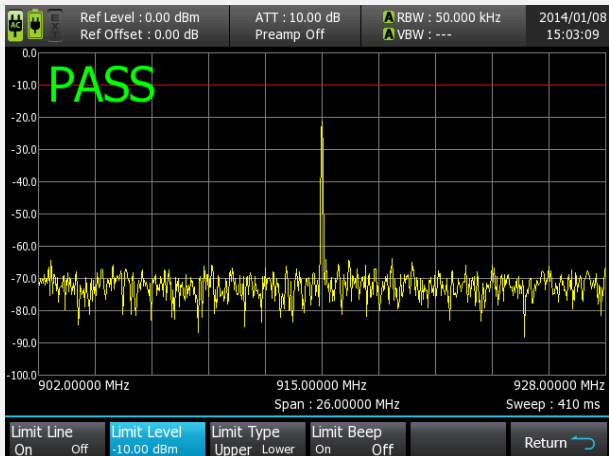

### Limit Level(F2) Setting

- On the left figure, press the Enter key to move the red limit line to Ref.Level -10dBm as shown in the right figure.

### 4.9.7.3 Limit Type(F3)

The Limit Type(F3) sets the conditions to compare the limit line with the trace amplitude and determine Pass or Fail. When it is set to Upper, if any point of the trace is larger than the limit line, the trace is processed as Fail. If all points are smaller than the limit line, the trace is processed as Pass. Reversely, when it is set to Lower, if any point of the trace is smaller than the limit line, the trace is processed as Fail. If all points are larger than the limit line, the trace is processed as Pass. The following figures show Pass and Fail determined based on the Limit Type(F3) setting.

## Key Stroke Sequence

System → More(F6) → Limit Line(F1) → Limit Type(F3)

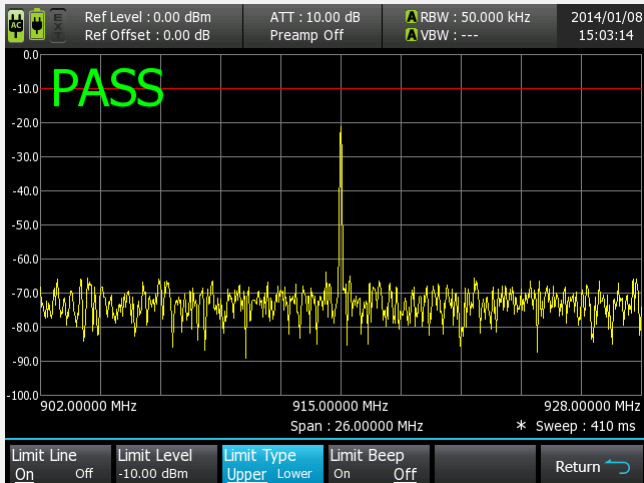

## Limit Type(F3) Upper

- When Limit Type(F3) is set to Upper, if any point of the trace is larger than the limit line, the trace is processed as Fail. If all points are smaller than the limit line, the trace is processed as Pass.



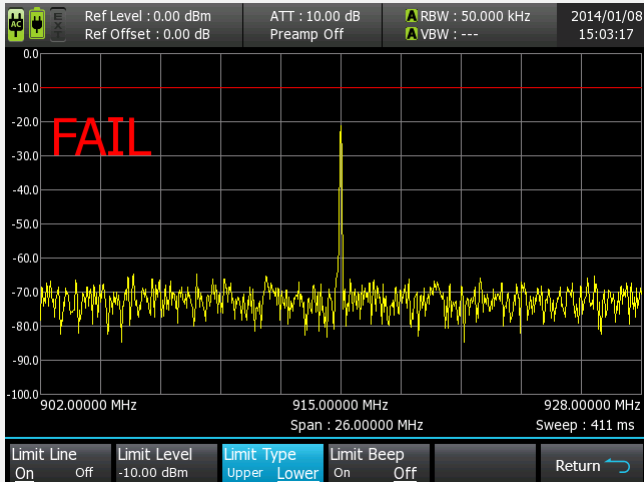

### Limit Type(F3) Lower

- When Limit Type(F3) is set to Lower, if any point of the trace is smaller than the limit line, the trace is processed as Fail. If all points are larger than the limit line, the trace is processed as Pass.

## 4.9.7.4 Limit Beep(F4)

The Limit Beep(F4) controls the beep output based on the Pass / Fail. The default is Off. When it is Off, beep is not output regardless of Pass or Fail. When it is On, beep is output for Fail but not output for Pass, allowing users to recognize fail by the beep sound. The following figures show Limit Beep(F4) On and Off.

## Key Stroke Sequence

System → More(F6) → Limit Line(F1) →  
Limit Beep(F4)

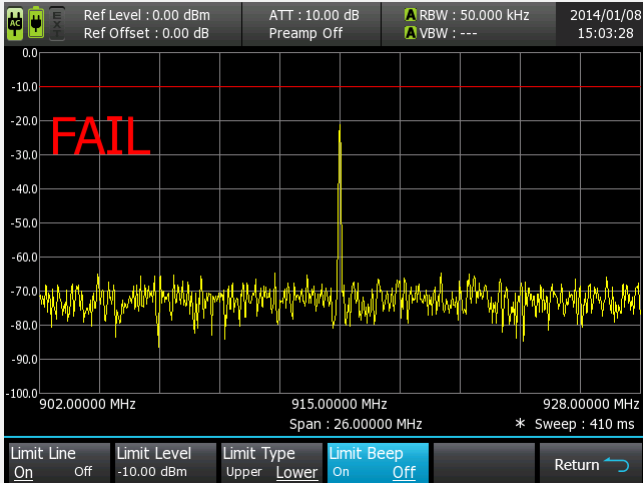

## Limit Beep(F4) Off

- Limit Beep(F4) default setting. When Limit Beep(F4) is Off, beep is not output regardless of Pass or Fail.

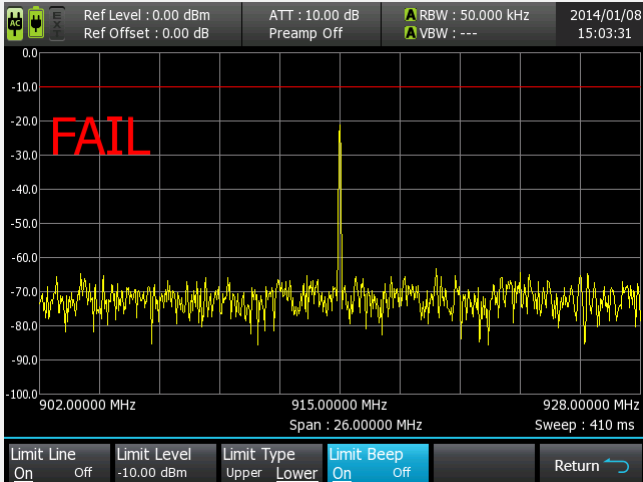

### Limit Beep(F4) On

- When Limit Beep(F4) is On, beep is output.
- Beep is not output for Pass; it is output for Fail.

# Menu Overview

## Frequency Entry



## Span Entry

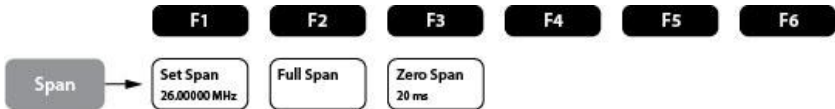

## Amplitude Entry

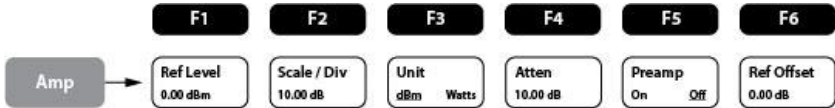

## Bandwidth/Sweep Entry

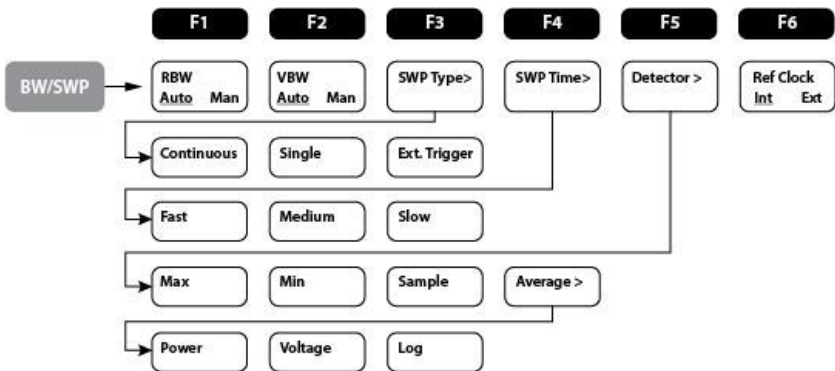

## Measurement Entry

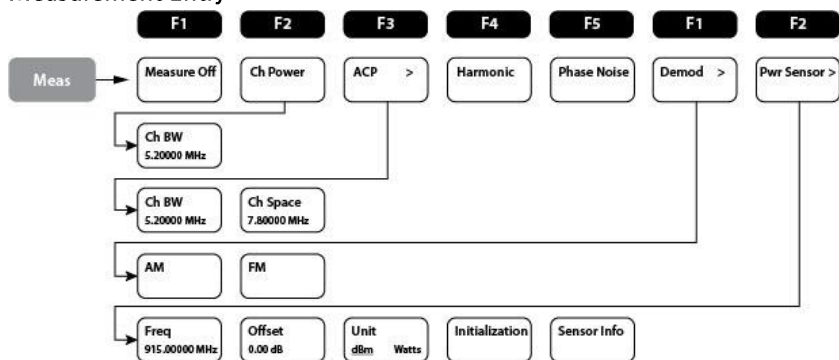

## Trace Entry

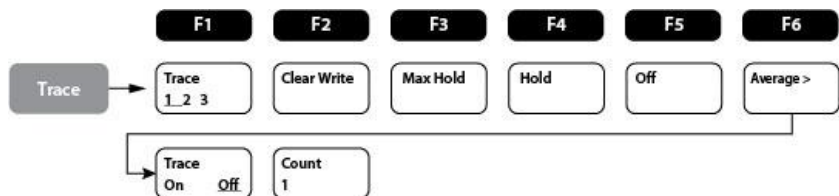

## Marker Entry

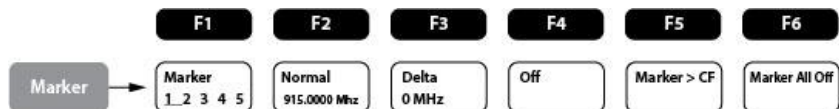

## Peak Entry

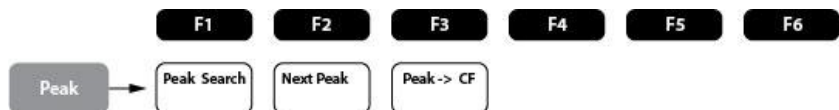

## System Entry

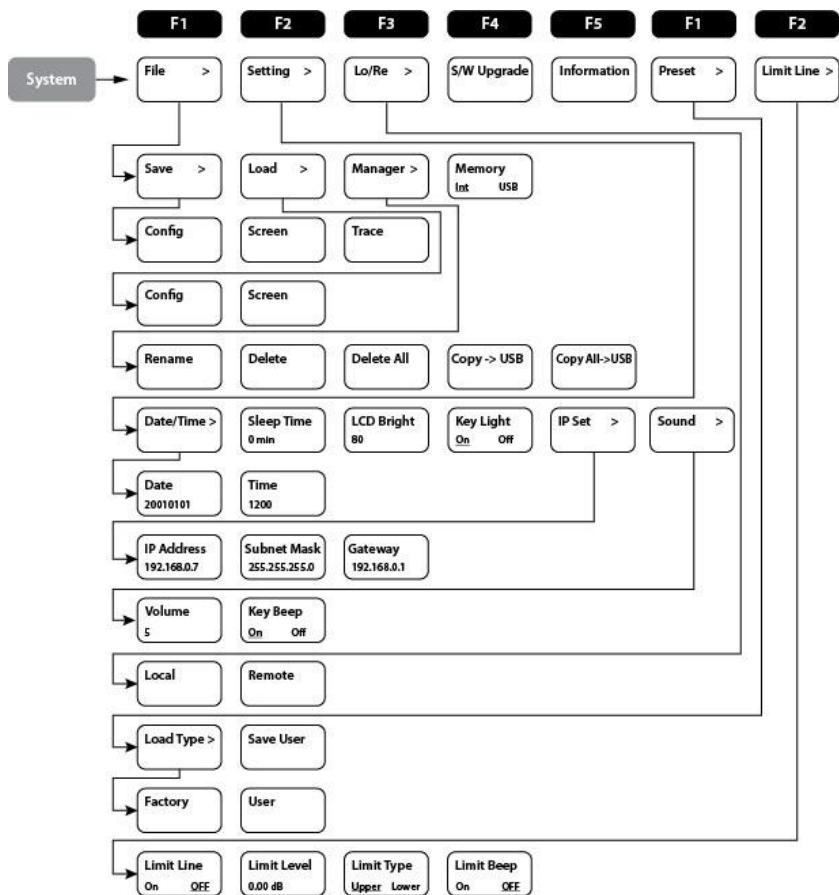

# 5

## **WARRANTY INFORMATION**

OPERATING  
MANUAL

## 5 WARRANTY INFORMATION

- This product has a two-year warranty.
- The manufacturer will repair or replace without charge, as any charger found defective in manufacture within the warranty period.
- The warranty is considered void if:
  - a) the defect or damage is caused by improper storage, misuse, neglect, inadequate maintenance, or accident;
  - b) the product is tampered with, modified or repaired by an unauthorized party;
  - c) the product's seals are tampered with;
  - d) the product has mechanical damage;
  - e) the unauthorized peripherals, parts or expendables have been used; or
  - f) the product has been used with the unauthorized power supply or in the unauthorized installation place.
- The batteries are not included or covered by this warranty.
- Recommended calibration interval is 2 year.

This warranty is valid for the original purchaser of the product. It is not valid for or transferred to the resold product.

GS Instruments is not liable for defects of the equipment caused by the unforeseeable or exceptional environment or defects caused by the users' careless usage or handling