

Instruction Manual

HI 2216

pH/mV/ISE/°C Bench Meter with Custom Buffers and Interval Logging

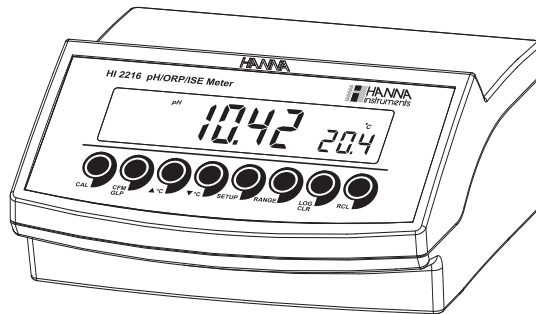

Dear Customer,
Thank you for choosing a Hanna Instruments product.
Please read this instruction manual carefully before using this instrument.
This manual will provide you with the necessary information for correct use of this instrument, as well as a precise idea of its versatility.
If you need additional technical information, do not hesitate to e-mail us at tech@hannainst.com or view our worldwide contact list at www.hannainst.com.

WARRANTY

HI 2216 is guaranteed for two years against defects in workmanship and materials when used for their intended purpose and maintained according to instructions. Electrodes and probes are guaranteed for six months. This warranty is limited to repair or replacement free of charge.

Damage due to accidents, misuse, tampering or lack of prescribed maintenance is not covered.

If service is required, contact the dealer from whom you purchased the instrument. If under warranty, report the model number, date of purchase, serial number and the nature of the problem. If the repair is not covered by the warranty, you will be notified of the charges incurred. If the instrument is to be returned to Hanna Instruments, first obtain a Returned Goods Authorization number from the Technical Service department and then send it with shipping costs prepaid. When shipping any instrument, make sure it is properly packed for complete protection.

TABLE OF CONTENTS

WARRANTY	2
PRELIMINARY EXAMINATION	3
GENERAL DESCRIPTION	3
FUNCTIONAL DESCRIPTION	4
SPECIFICATIONS	5
OPERATIONAL GUIDE	6
pH CALIBRATION	9
pH BUFFER TEMPERATURE DEPENDENCE	14
ISE CALIBRATION	15
RELATIVE mV CALIBRATION	18
GOOD LABORATORY PRACTICE (GLP)	18
LOGGING FUNCTION	23
SETUP	28
TEMPERATURE CALIBRATION (for technical personnel only)	33
mV CALIBRATION (for technical personnel only)	34
PC INTERFACE	35
ELECTRODE CONDITIONING & MAINTENANCE	40
TROUBLESHOOTING GUIDE	43
TEMPERATURE CORRELATION FOR pH SENSITIVE GLASS	44
ACCESSORIES	45

PRELIMINARY EXAMINATION

Remove the instrument from the packing material and examine it carefully to make sure that no damage has occurred during shipping. If there is any damage, notify your Dealer or the nearest Hanna Customer Service Center.

Each instrument is supplied with:

- **HI 1131B** Glass-body Combination pH Electrode with 1 m (3.3') Cable
- **HI 7662** Temperature Probe
- **HI 76404N** Electrode Holder
- **pH 4.01 & 7.01** Buffer Solutions (20 mL each)
- **HI 7071** Electrolyte Solution
- **HI 700661** Cleaning Solution
- 12VDC Power Adapter
- Instruction Manual

Note: Save all packing material until you are sure that the instrument functions correctly. All defective items must be returned in the original packing with the supplied accessories.

GENERAL DESCRIPTION

The **HI 2216** is state of the art, heavy-duty pH, mV, ISE meter designed to provide laboratory results and accuracy under harsh industrial conditions.

HI 2216 can also measure Oxidation Reduction Potential (ORP) in mV range.

Relative mV feature is also provided.

pH measurements are compensated for temperature effect manually or automatically with the **HI 7662** temperature probe.

Up to a five-point pH calibration can be performed using seven standard buffers. In addition, two custom buffers can be used during calibration.

Up to a two-point ISE calibration can be performed using five standard solutions.

The **GLP** feature provides data consistency.

A calibration due alarm can be set to alert the user that too much time elapsed since the last pH calibration.

Data can be stored in meter's memory for later retrieval.

An USB connection ensures communication with a PC.

The meter's memory can hold 200 manually logged points and 500 lot logging points.

FUNCTIONAL DESCRIPTION

Front Panel

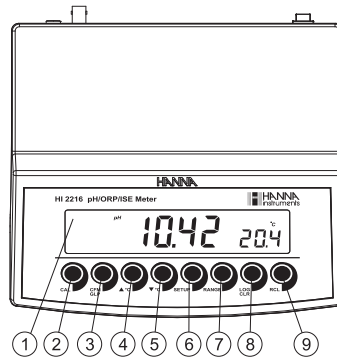

Rear Panel

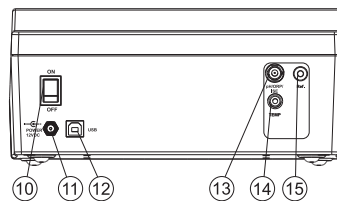

- 1) Liquid Crystal Display (LCD).
- 2) **CAL** key, to enter and exit calibration mode.
- 3) **CFM/GLP** key, to confirm calibration, different values or to display Good Laboratory Practice information.
- 4) **▲ °C** key, to manually increase temperature value or other parameters.
- 5) **▼ °C** key, to manually decrease temperature value or other parameters.
- 6) **SETUP** key, to enter/exit SETUP mode.
- 7) **RANGE** key, to select measurement range, switch to focused data in SETUP or toggle between buffer value and temperature during calibration.
- 8) **LOG/CLR** key, to store a value into memory, to clear pH calibration, or to delete log records.
- 9) **RCL** key, memory recall.
- 10) **ON/OFF** switch.
- 11) Power supply socket.
- 12) USB connector.
- 13) BNC electrode connector.
- 14) Temperature probe socket.
- 15) Electrode reference socket.

SPECIFICATIONS

RANGE	–2.0 to 16.0 pH –2.00 to 16.00 pH –2.000 to 16.000 pH
	±999.9 mV (ORP) ±2000 mV (ORP)
	0.001 to 19990 ppm
	–20.0 to 120.0 °C (–4.0 to 248.0 °F)
RESOLUTION	0.1 pH, 0.01 pH, 0.001 pH
	0.1 mV (±999.9 mV) (ISE&ORP) 1 mV (±2000 mV) (ISE&ORP)
	0.001 (to 1.999 ppm) 0.01 (to 19.99 ppm) 0.1 (to 199.9 ppm) 1 (to 1999 ppm) 10 (to 19990 ppm)
	0.1 °C
ACCURACY @ 20°C / 68°F	±0.1pH, ±0.01pH, ±0.002 pH
	±0.2 mV (±999.9 mV) ±1 mV (±2000 mV)
	±0.5% FS
	±0.2 °C (excluding probe error)
Rel mV offset range	±2000 mV
pH Calibration	Automatic, up to 5 point calibration, 7 standard buffers available (1.68, 4.01, 6.86, 7.01, 9.18, 10.01, 12.45), and 2 custom buffers
ISE Calibration	Automatic, 1 or 2 points, 5 buffers available (0.1, 1, 10, 100, 1000ppm)
Temperature compensation	Automatic (with HI 7662 probe) or manual from –20.0 to 120.0 °C
pH Electrode	HI 1131B , glass-body, single junction, refillable, BNC connector (included)
Temperature probe	HI 7662 (included)
Input impedance	10 ¹² ohms
Log feature	200 records log on demand
Log Interval feature	Stability logging (StAb), 5, 10, 30 sec 1, 2, 5, 10, 15, 30, 60, 120, 180 min
PC communication	Opto-isolated USB
Power supply	12 VDC adapter (included)
Environment	0 – 50 °C (32 – 122 °F) max. 95% RH non-condensing
Dimensions	235 x 222 x 109 mm (9.2 x 8.7 x 4.3")
Weight	1.3 Kg (2.9 lb)
Warranty	2 years

OPERATIONAL GUIDE

POWER CONNECTION

Plug the 12 VDC adapter into the power supply socket.

- Notes:**
- This instrument uses non volatile memory to retain the pH, mV, temperature calibrations and all other settings, even when unplugged.
 - Make sure a fuse protects the main line.

ELECTRODE AND PROBE CONNECTIONS

For pH or ORP measurements connect an electrode with internal reference to the BNC connector on the back of the instrument.

For electrodes with a separate reference connect the electrode's BNC to the BNC connector and the reference electrode plug to the reference socket.

For temperature measurements and automatic temperature compensation connect the temperature probe to the appropriate socket.

INSTRUMENT START-UP

- Turn the instrument on by pressing the ON/OFF switch located on the rear panel.
- All LCD tags are displayed and a beep is sounded while the instruments perform a self test.



- The instrument will display "LoAd" message and "∞" blinking until initialization is complete.

pH MEASUREMENTS

Make sure the instrument has been calibrated before taking pH measurements.

- Submerge the electrode tip and the temperature probe approximately 3 cm (1 1/4") into the sample to be tested and stir gently. Allow time for the electrode to stabilize.
- The pH is displayed on the primary LCD and the temperature on the secondary LCD.

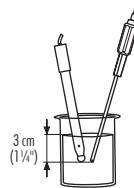

- If the reading is out of range, the closest full-scale value will be displayed blinking on the primary LCD.

If measurements are taken successively in different samples, it is recommended to rinse the electrode thoroughly with deionized water or tap water and then with some of the next sample to prevent cross-contamination.

The pH reading is affected by temperature. In order to measure the pH accurately, the temperature effect must be compensated for. To use the Automatic Temperature Compensation feature, connect and submerge the HI 7662 temperature probe into the sample as close as possible to the electrode and wait for a few seconds.

If the temperature of the sample is known, manual temperature compensation can be used by disconnecting the temperature probe.

The display will show the last temperature reading with the "°C" tag blinking.

The temperature can now be adjusted with the **ARROW** keys (from -20.0 °C to 120.0 °C).



mV/ORP MEASUREMENTS

An optional ORP electrode must be used to perform ORP measurements (see Accessories).

Oxidation-Reduction Potential (REDOX) measurements provide the quantification of the oxidizing or reducing power of the tested sample.

The surface of the ORP electrode must be clean and smooth in order to obtain an accurate measurement.

- Press **RANGE** to enter mV range.
- Submerge the tip of the ORP electrode 3 cm (1 1/4") into the sample to be tested and allow a few seconds for the reading to stabilize.
- The instrument displays the mV reading on the primary LCD and the temperature on the secondary LCD.

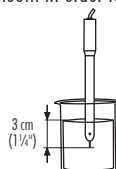

- If the reading is out of range, the closest full-scale value will be displayed blinking on the primary LCD.



RELATIVE mV MEASUREMENTS

- Press **RANGE** until “rEL” message and “mV” tag are displayed for one second. After one second the temperature will be displayed on the secondary LCD and the “mV” tag will blink.



The reading displayed by the instrument is equal to the difference between the current mV input value and relative mV offset established in the relative mV calibration.

ISE MEASUREMENT

To perform ion concentration measurements, connect an optional ISE electrode to the instrument input (BNC or BNC and REF if separate reference electrode is used). Enter the ISE mode by pressing **RANGE** key until the display changes to ppm. Select the corresponding ion charge in the **SETUP** menu.

Submerge the ISE electrode (reference electrode) and temperature probe (3 cm/1 1/4") into the sample to be tested and wait a few seconds for the reading to stabilize.

The ppm reading will be displayed on the primary LCD and the current temperature value on the secondary LCD.

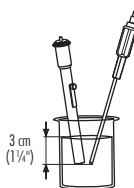

In order to take accurate ISE measurements, make sure that the appropriate ion charge was set in the **SETUP** menu and the instrument was calibrated (see **ISE CALIBRATION** for details, page 15).

- Notes:**
- When the reading is out of range, the display will flash the closest full-scale value.
 - The instrument will display “----” on the primary LCD if it is not calibrated. Perform at least a one-point calibration if the ion charge is -1, 1, -2, 2 or a two-point calibration for the “**undF**” option selected in **SETUP** menu in order to take ISE measurements.

TEMPERATURE MEASUREMENTS

Connect the **HI 7662** temperature probe to the appropriate socket and turn the instrument on.

Submerge the temperature probe into the sample and allow the reading on the secondary LCD to stabilize.



pH CALIBRATION

Calibrate the instrument frequently, especially if high accuracy is required.

The instrument should be recalibrated:

- Whenever the pH electrode is replaced.
- At least once a week.
- After testing aggressive chemicals.
- If “CAL” “INTV” tags are blinking during measurement.

Every time you calibrate the instrument use fresh buffers and perform an electrode Cleaning Procedure (see page 42).

PREPARATION

Pour small quantities of the buffer solutions into clean beakers. If possible, use plastic or glass beakers to minimize any EMC interferences.

For accurate calibration and to minimize cross-contamination, use two beakers for each buffer solution. One for rinsing the electrode and one for calibration.

If you are measuring in the acidic range, use pH 7.01 or 6.86 as first buffer and pH 4.01 as second buffer. If you are measuring in the alkaline range, use pH 7.01 or 6.86 as first buffer and pH 10.01 or 9.18 as second buffer.

PROCEDURE

Calibration can be performed up to five-points.

For accurate measurements a three-point calibration is recommended.

The calibration buffer can be selected from the calibration buffer list that includes the custom buffers and the memorized standard buffers:

- pH 1.68, 4.01, 6.86, 7.01, 9.18, 10.01 and 12.45.

The custom buffers allow the user to calibrate in a buffer solution different from a standard one. Up to two custom buffers can be set in SETUP menu (see page 28). Each custom buffer value can be changed in a ± 1.0 pH window around the set value, during calibration, when it is selected; the "BUFFER pH" tag will blink.

The instruments will automatically skip the buffer used during calibration and the buffers which are in a ± 0.2 pH window, around one of the calibrated buffers.

All new calibrations will override existing stored calibration data in a ± 0.2 pH window. The slopes adjacent to the new points will be reevaluated.

FIVE-POINT CALIBRATION

- Submerge the pH electrode and the temperature probe approximately 3 cm (1 1/4") into a buffer solution and stir gently. The temperature probe should be close to the pH electrode.
- Press **CAL**. The "CAL" and "☰" tags will appear and the "7.01" buffer will be displayed on the secondary LCD.

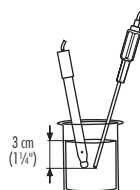







- If necessary, press the **ARROW** keys to select a different buffer value.
- The "☒" tag will blink on the LCD until the reading is stable.
- When the reading is stable and close to the selected buffer, the "READY" tag will be displayed and the "CFM" tag will blink.



- Press **CFM** to confirm calibration.
- The calibrated value will be displayed on the primary LCD and the second expected buffer value on the secondary LCD.
- After the first calibration point is confirmed, submerge the pH electrode and the temperature probe approximately 3 cm (1 1/4") into the second buffer solution and stir gently. The temperature probe should be close to the pH electrode.



- If necessary, press the **ARROW** keys to select a different buffer value.

- The “Σ” tag will blink on the LCD until the reading is stable.
- When the reading is stable and close to the selected buffer, the “READY” tag will be displayed and the “CFM” tag will blink. 
- Press **CFM** to confirm calibration. 
- The calibrated value is then displayed on the primary LCD and the third expected buffer value on the secondary LCD.
- After the second calibration point is confirmed, submerge the pH electrode and the temperature probe approximately 3 cm (1¼”) into the next buffer solution and stir gently. The temperature probe should be close to the pH electrode.
- If necessary, press the **ARROW** keys to select a different buffer value.
- The “Σ” tag will blink on the LCD until the reading is stable.
- When the reading is stable and close to the selected buffer, the “READY” tag will be displayed and the “CFM” tag will blink. 
- Press **CFM** to confirm calibration. 
- The calibrated value is then displayed on the primary LCD and the fourth expected buffer value on the secondary LCD.
- After the third calibration point is confirmed, submerge the pH electrode and the temperature probe approximately 3 cm (1¼”) into the next buffer solution and stir gently. The temperature probe should be close to the pH electrode.
- If necessary, press the **ARROW** keys to select a different buffer value.
- The “Σ” tag will blink on the LCD until the reading is stable.
- When the reading is stable and close to the selected buffer, the “READY” tag will be displayed and the “CFM” tag will blink. 
- Press **CFM** to confirm calibration. 
- The calibrated value is then displayed on the primary LCD and the fifth expected buffer value on the secondary LCD.
- After the fourth calibration point is confirmed, submerge the pH electrode and the temperature probe approximately 3 cm (1¼”) into the next buffer solution and stir gently. The temperature probe should be close to the pH electrode.
- If necessary, press the **ARROW** keys to select a different buffer value.
- The “Σ” tag will blink on the LCD until the reading is stable.

- When the reading is stable and close to the selected buffer, the “READY” tag will be displayed and the “CFM” tag will blink.
- Press **CFM** to confirm the fifth calibration point.
- The instrument stores the calibration value and returns to normal measurement mode.



FOUR, THREE OR TWO-POINT CALIBRATION

- Proceed as described in “FIVE-POINT CALIBRATION” section.
- Press **CAL** after the fourth, third or second calibration point was confirmed. The instrument will memorize the calibration data and return to measurement mode.

ONE-POINT CALIBRATION

Two **SETUP** selectable options are available: “**Pnt**” and “**OFFS**”.

If the “**Pnt**” option is selected, the new calibration point overrides an existing one. The adjacent slopes will be reevaluated.

If the “**OFFS**” option is selected, an electrode offset correction is performed. The adjacent slopes will remain unchanged.

- Proceed as described in “FOUR, THREE or TWO-POINT CALIBRATION” section.
- Press **CAL** after the first calibration point was confirmed. The instrument will memorize the one-point calibration data and will return to measurement mode.

- Notes:**
- If the value measured by the instrument is not close to the selected buffer, “**WRONG**” “**⚠**” and “**WRONG**” “**!**” tags will blink alternately. Check if the correct buffer has been used, or clean the electrode by following the Cleaning Procedure (see page 42). If necessary, change the buffer or the electrode.
 - When a custom buffer is displayed, the “**BUFFER pH**” tag blinks. To change the custom buffer value in accordance with the buffer temperature proceed as described in “WORKING WITH CUSTOM BUFFERS” (see page 13).
 - If the buffer temperature or the manual temperature exceeds the temperature limits of the buffer, “**WRONG**” tag and temperature reading will blink.
 - If “**WRONG**”, “**BUFFER pH**” tags and “**OLD**” message are displayed blinking on the secondary LCD line, an inconsistency between new and previous (old) calibration is detected.

Clear calibration parameters and proceed with calibration from the current calibration point. The instrument will keep all confirmed values during current calibration.

- To clear calibration parameters for all uncalibrated buffers starting with current buffer, press CLR. The calibration will continue from the current point. If this procedure is performed while calibrating in the first calibration point, the instrument returns to measurement mode.



- Press **RANGE** to toggle between pH buffer, calibration buffer number and temperature reading.
- Each time a buffer is confirmed, the new calibration data replaces the old data for the corresponding buffer. If current buffer has no previous data stored and the calibration is not full (five buffers), the current buffer is added to the existing calibration. If the existing calibration is full, the instrument asks which buffer to replace.



Press the **ARROW** keys to select another buffer to be replaced.

Press **CFM** to confirm the buffer that will be replaced.

Press **CAL** to leave calibration without replacing.

Note: If the replaced buffer is outside the ± 0.2 pH window, around each of the calibrated buffers, it is possible to select this buffer for next calibration during current calibration.

WORKING WITH CUSTOM BUFFERS

If a custom buffer was set in SETUP menu, it can be selected during calibration by pressing the **ARROW** keys. The "BUFFER pH" tag will blink.

Press **SETUP** if you want to adjust the buffer value. The buffer value will start blinking.



Use the **ARROW** keys to change the buffer value.

After 5 seconds, the buffer value is updated. Press **SETUP** if you want to change it again.

Note: Custom buffer value can be adjusted in a ± 1.00 pH window, around the set value.

pH BUFFER TEMPERATURE DEPENDENCE

The temperature has an effect on pH. The calibration buffer solutions are affected by temperature changes to a lesser degree than normal solutions. During calibration the instrument will automatically calibrate to the pH value corresponding to the measured or set temperature.

TEMP		pH BUFFERS						
°C	°F	1.68	4.01	6.86	7.01	9.18	10.01	12.45
0	32	1.67	4.01	6.98	7.13	9.46	10.32	13.38
5	41	1.67	4.00	6.95	7.10	9.39	10.24	13.18
10	50	1.67	4.00	6.92	7.07	9.33	10.18	12.99
15	59	1.67	4.00	6.90	7.05	9.27	10.12	12.80
20	68	1.68	4.00	6.88	7.03	9.22	10.06	12.62
25	77	1.68	4.01	6.86	7.01	9.18	10.01	12.45
30	86	1.68	4.02	6.85	7.00	9.14	9.96	12.29
35	95	1.69	4.03	6.84	6.99	9.11	9.92	12.13
40	104	1.69	4.04	6.84	6.98	9.07	9.88	11.98
45	113	1.70	4.05	6.83	6.98	9.04	9.85	11.83
50	122	1.71	4.06	6.83	6.98	9.01	9.82	11.70
55	131	1.72	4.08	6.84	6.98	8.99	9.79	11.57
60	140	1.72	4.09	6.84	6.98	8.97	9.77	11.44
65	149	1.73	4.11	6.84	6.99	8.95	9.76	11.32
70	158	1.74	4.12	6.85	6.99	8.93	9.75	11.21
75	167	1.76	4.14	6.86	7.00	8.91	9.74	11.10
80	176	1.77	4.16	6.87	7.01	8.89	9.74	11.00
85	185	1.78	4.17	6.87	7.02	8.87	9.74	10.91
90	194	1.79	4.19	6.88	7.03	8.85	9.75	10.82
95	203	1.81	4.20	6.89	7.04	8.83	9.76	10.73

During calibration the instrument will display the pH buffer value at 25 °C.

ISE CALIBRATION

It is recommended to calibrate the instrument frequently, especially if high accuracy is required.

The ppm range should be recalibrated:

- Whenever the ISE electrode is replaced.
- When the ion charge is changed in SETUP menu.
- At least once a day.
- After testing aggressive chemicals.
- When calibration is expired - "CAL" "INTV" tags blink (if feature is enabled).

Due to electrode conditioning time, the electrode must be kept submerged a few seconds to stabilize.

PROCEDURE

Select the proper ion charge in SETUP menu (see SETUP for details, page 28).

Note: If "undF" option is selected in SETUP menu, calibration must be performed at two points. Otherwise "----" message will be displayed on the LCD.

Pour small quantities of the calibration solutions into clean beakers. If possible, use plastic beakers to minimize any EMC interferences.

For accurate calibration and to minimize cross-contamination, use two beakers for each calibration solution. One for rinsing the electrode and one for calibration.

Note: ISA needs to be added to all calibration solutions. See sensor manual.

The instrument offers a choice of six standard solutions: 0.1, 1, 10, 100, 1000, 10000 ppm and calibration up to two points. Standards should bracket the working range.

Remove the protective cap from the ISE electrode.

TWO-POINT CALIBRATION

- Submerge the ISE electrode approximately 3 cm (1¼") into the selected solution and stir gently.
- Press CAL. The primary LCD will display the ppm value using the current offset and slope. The "CAL" and "CAL" tags will appear and "10.0" ppm standard will be displayed on the secondary LCD.

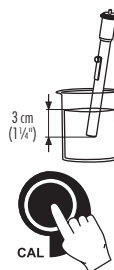

- If necessary, press the **ARROW** keys to select a different standard value.
- The “**Σ**” tag will blink on the LCD until the reading is stable.
- When the reading is stable and close to the selected standard, the “**READY**” tag will be displayed and the “**CFM**” tag will blink.
- Press **CFM** to confirm calibration.
- The calibrated value will be displayed on the primary LCD and the second expected standard value on the secondary LCD.



Note: The instrument will automatically skip the standard used for the first point.

- After the first calibration point is confirmed, submerge the ISE electrode approximately 3 cm (1 ¼”) into the second calibration solution.
- If necessary, press the **ARROW** keys to select a different standard value.
- The “**Σ**” tag will blink on the LCD until the reading is stable.
- When the reading is stable and close to the selected standard, the “**READY**” tag will be displayed and the “**CFM**” tag will blink.
- Press **CFM** to confirm calibration.
- The instrument stores the calibration value and returns to normal measurement mode.



- Notes:**
- If the mV value is out of the mV range (± 2000), “**WRONG**” “**Σ**” and “**WRONG**” “**V**” tags will blink alternately. In this case, check if the correct standard has been used.
 - If the new slope is out of the slope window, “**WRONG**” “**Σ**” and “**WRONG**” “**V**” tags will blink alternately. In this case, check if the correct standard has been used.

Slope window is between ± 20 mV and ± 120 mV if ion charge is not specified (undF option in SETUP menu) or between 50% and 120% of default slope for the corresponding ion charge.

Default slope value (mV/decade):

- 59.16 (monovalent cation) - ion charge is 1
- 59.16 (monovalent anion) - ion charge is -1
- 29.58 (divalent cation) - ion charge is 2
- 29.58 (divalent anion) - ion charge is -2
- 100 - ion charge is "undF"

- Press **CLR** during calibration if you want to clear calibration values. The instrument will display "CLR" message and will return to measurement mode.
- The calibration needs to be cleared when a new electrode is attached to the meter.
- The instrument will display "----" on the primary LCD if it is not calibrated or after all calibrations are cleared.
- Press **RANGE** to display the temperature reading on the LCD during calibration.



ONE-POINT CALIBRATION

- Press **CAL** after first calibration point was confirmed. The instrument memorizes the one-point calibration information and returns to measurement mode.
- Press **RANGE** to display the temperature reading on the LCD during calibration.



RELATIVE mV CALIBRATION

- Press **CAL** when the instrument is in RELATIVE mV measurement mode. The “mV” and “Σ” tags will be displayed. Absolute mV is displayed on the primary LCD and “Abs” message is displayed on the secondary LCD.
- When the absolute reading is stable and in measurement range, the instrument asks for confirmation.
- If the reading is out of range, “WRONG” tag will be displayed.
- Press **CFM** to confirm the absolute value. The instrument will display “0.0 mV” on the primary LCD and “rEL” message on the secondary LCD. In this moment the relative mV offset is equal to absolute mV reading.
- Use the **ARROW** keys if you want to change the displayed relative mV value.
- Press **CFM** to confirm the relative mV value. The relative mV offset is displayed on the primary LCD. The instrument returns to measurement mode.

Note: The relative mV value can be changed only inside the relative mV offset window (± 2000 mV).

GOOD LABORATORY PRACTICE (GLP)

GLP is a set of functions that allows storage and retrieval of data regarding the maintenance and status of the electrode.

All data regarding pH, Rel mV or ISE calibration is stored for the user to review when necessary.

EXPIRED CALIBRATION

This instrument allows the user to set the number of days before the next required calibration. This value can be set from 1 to 7 days. The default setting is off (disabled). The “CAL” “INTV” tags will start blinking to warn the user that the instrument should be recalibrated.

For example, if a 4 days time out has been selected, the instrument will issue the alarm exactly 4 days after the last calibration.

If the expiration value is changed (e.g. to 5 days), then the alarm will be immediately recalculated and appear 5 days after the last calibration.

- Notes:**
- When the instrument is not calibrated or calibration is cleared (default values loaded) there is no “expired calibration”, and the display always shows the “CAL” “INTV” tags blinking.
 - When an abnormal condition in the RTC is detected, the instrument forces the “expired calibration” status.

pH CALIBRATION DATA

Calibration data is stored automatically after a successful calibration. To view the pH calibration data, press **GLP** while in measurement mode. The instruments will display the time (hh:mm) of the last calibration.



Use the **ARROW** keys to scroll through the calibration data:

- The date (yyyy.mm.dd).



- The pH calibration offset.

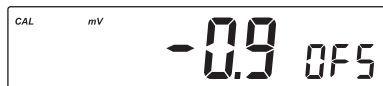

- The pH calibration slope (the GLP slope is the average of the calibration slopes; the percentage is referred to the ideal value of 59.16 mV/pH).



- The pH calibration buffers in calibrating order and with the selected resolutions at calibration moment.

The first pH calibration buffer:



The second pH calibration buffer:



The third pH calibration buffer:



The fourth pH calibration buffer:



The fifth pH calibration buffer:



- Notes:**
- The "Old" message displayed beside the pH value means that this buffer was not used during last calibration. Press and hold down **SETUP** if you want to see calibration date (or time, if old calibration was performed on the same day as the current calibration).
 - For each custom buffer used in calibration, the "BUFFER pH" tag will blink.
 - If "no buf" message appears on the LCD, the instrument informs you that the calibration was performed with less than five buffers.



- Calibration Expiration status:
 - if disabled.



- or the number of days until the calibration alarm will be displayed.

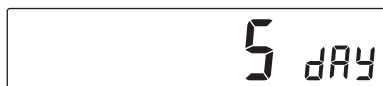

- or if expired (7 days ago).



- The instrument ID.



- Notes:**
- Press **GLP** to return to measurement mode.
 - If calibration has not been performed, the instruments display “no CAL” message blinking.



ISE CALIBRATION DATA

The ISE calibration data is stored automatically.

To view ISE calibration data, press **GLP** when the instrument is in ISE measurement mode.

The instrument will display the time (hh:mm) of the last calibration.



Use the **ARROW** keys to scroll through the calibration data:

- The date (yyyy.mm.dd).



- The calibration slope (mV/decade).



- The first calibration solution.



- The second calibration solution.



- Calibration Expiration status:
- if disabled.



- or the number of days until the calibration alarm will be displayed.



- or if expired (7 days ago).



- The instrument ID.



- Notes:**
- If a one-point calibration is performed after a two-point calibration, the instrument will keep the old slope.
 - If "no bUF" message appears on the LCD, the instrument informs you that calibration was performed at only one point.
 - Press **GLP** at any moment and the instrument will return to measurement mode.
 - If calibration has not been performed, the instrument displays "no CAL" message blinking.



LAST RELATIVE mV CALIBRATION DATA

Last Relative mV calibration data is stored automatically after a successful calibration.

To view the Relative mV calibration data, press **GLP** while in Relative mV measurement mode.

The instrument will display the Relative mV GLP information and the time (hh:mm:ss) of the last Rel mV calibration.

Use the **ARROW** keys to scroll through the calibration data:

- The Relative mV calibration date.
- The Relative mV calibration offset.
- The instrument ID.

- Notes:**
- Press **GLP** to return to measurement mode.
 - If calibration has not been performed, the instrument displays "no CAL" message blinking.

LOGGING FUNCTION

Up to 700 LOG samples can be stored into memory.

200 manually logged records and 500 logging records can be stored in the memory. To select logging type enter SETUP menu.

LOGGING THE CURRENT DATA (manual logging)

Select the manual logging mode in SETUP menu.

To store the current reading into memory press **LOG** while the instrument is in measurement mode.

The instrument will display "MAN" on the primary LCD, the record number on the secondary LCD and "LOG" tag for a few seconds (see example below: record No. 5):



followed by the number of free records:



If there are less than 6 memory locations remaining, the record number and "Lo" message will be displayed to alert the user.

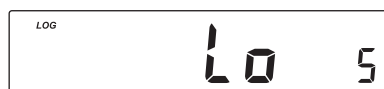

If the log space is full (200 records), "FULL LOG" message will be displayed and no more data will be saved.



When **LOG** is pressed, a complete set of information is stored: date, time, pH, mV, temperature and calibration data.

LOT LOGGING

Select "StAb" (stability logging) or the desired time interval.

To start interval logging press LOG key while the instrument is in measurement mode.

When the selected interval is reached, the instrument will display the current lot number on the primary LCD line, the record number on the secondary LCD line and the "LOG" tag (see example below: Lot 5 record 7)



followed by the number of free records on the corresponding memory space.



If stability logging is selected, a complete set of data is memorized every time the reading becomes stable after an unstable condition.

To stop interval logging press LOG key again.

Note: When pressing any key that is not active, while Log interval is running, the following message is displayed for a few seconds:



VIEW LOGGED DATA

Press RCL while in measurement mode to retrieve the stored information.

If no data were logged for the current selected measurement range and no lots are memorized, one of the next messages will be displayed:



No pH measurement records:



No Relative mV and mV records:



No ISE records:



Otherwise, the instrument will display the lot number on the primary LCD line, the number of records on the secondary, "LOG" tag and "CFM" blinking. If samples were logged on demand "MAn" will be displayed on the primary LCD and the number of samples logged on the secondary (see example below: manual log, 15 samples logged).



Press **ARROW** keys to select different lot.

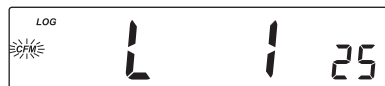

All the existing lots are displayed.

Press **CFM** to view record information.

The instrument will display the **pH** or **relative mV** or **ppm** value on the primary LCD and the last stored record number on the secondary LCD, along with "LOG" tag.



or



or



Use the **ARROW** keys to scroll through the records.

To view additional information press **RANGE**:

- The **mV** value is displayed on the primary LCD and the temperature value on the secondary LCD.



- The **time (hh.mm.ss)** is displayed on the LCD, along with the “TIME” tag.



- The **date (yyyy.mm.dd)** is displayed on the LCD along with the “DATE” tag.



- The calibration **offset** is displayed on the primary LCD and “OFS” message on the secondary LCD.



Note: If in ISE RECALL mode, the instruments will display “----” message on the primary LCD.

- The calibration **slope** is displayed on the primary LCD and “SLP” message on the secondary LCD.



Note: If in Relative mV RECALL mode, the instruments will display “----” message on the primary LCD.

- The interval for lot logging.



To delete a lot, use the **ARROW** keys to select the desired lot. Press **CLR** key, “dEL Lot” will appear in the display. Press **CFM** key to delete.

To delete manual logged records press **CFM** while “MAn” is displayed to view manually logged records. Press the **RCL** key, “dEL” and the record number will be displayed. Press **CFM** to delete.

Use the **ARROW** keys to change the record number.

The "dEL" message is displayed on the primary LCD and the selected record on the secondary LCD, along with "LOG" tag.



- Notes:**
- The **ARROW** keys can be used to change the record.
 - Press **SETUP** to delete all records/lots. The display will show "dEL" in the primary LCD and "ALL" in the secondary LCD.



- Press **CFM** to confirm delete.
- Press **RANGE** to escape and return to the RCL screen.
- If "dEL ALL" option was selected, all the log on demand records or lots are deleted. While deleting the "dEL" tag is displayed blinking.
- Press **RCL** exit record information and enter lot information.
- Press **RCL** again to return to measurement mode.
- If one or more records/lots were deleted the "dEL" tag blinks until the log memory space is reorganized.

SETUP

Setup mode allows viewing and modifying the following parameters:

- Expired Calibration Alarm
- Log Interval
- First Custom Buffer
- Second Custom Buffer
- One-point Calibration Behavior
- pH Resolution
- Ion Charge
- Current Time (hour & minute)
- Current Date (year, month & day)
- Beep Status
- Instrument Id
- Temperature Unit

To enter SETUP mode press **SETUP** while the instrument is in measurement mode.

Select a parameter with the **ARROW** keys.

Press **CAL** to change a parameter value. The selected parameter will start blinking.

Press **RANGE** to toggle between displayed parameters.

Press the **ARROW** keys to increase or decrease the displayed value.

Press **CFM** to save the modified value or **CAL** to escape without saving.

EXPIRED CALIBRATION ALARM

Press **CAL** when the calibration time-out is displayed. Calibration time-out (“OFF” or “1” to “7” days) and “CFM” will start blinking.

Press the **ARROW** keys to change the calibration time-out value.



Press **CFM** to save the modified calibration time-out value.

Press **CAL** to escape without saving.

LOG INTERVAL

Press **CAL** when log interval is displayed. The log interval and “CFM” will start blinking (“MAn” for log on demand, “StAb” log on stability, interval in seconds or minutes).

Press the **ARROW** keys to change the custom buffer value.



Press **CFM** to confirm the selection.

Press **CAL** to escape without saving.

FIRST CUSTOM BUFFER

Press **CAL** when “cb1” is displayed. The custom buffer (disabled – “no” or “0” to “16” pH) and “CFM” will start blinking.

Press the **ARROW** keys to change the custom buffer value.



Press **CFM** to save the modified custom buffer value.

Press **CAL** to escape without saving.

Note: To delete custom buffer press **CAL** then press **CLR** key.

SECOND CUSTOM BUFFER

Press **CAL** when “cb2” is displayed. The custom buffer (disabled – “no” or “0” to “16” pH) and “CFM” will start blinking.

Press the **ARROW** keys to change the custom buffer value.



Press **CFM** to save the modified custom buffer value.

Press **CAL** to escape without saving.

ONE-POINT CALIBRATION BEHAVIOR

Press **CAL** when "1 Pnt" message is displayed on the secondary LCD. One of the two options ("Pnt" or "OFFS") and "CFM" will start blinking (see pH CALIBRATION PROCEDURE for details, page 9).

Press the **ARROW** keys to toggle between "Pnt" and "OFFS" options.



Press **CFM** to save the behavior for one-point calibration.

Press **CAL** to escape without saving.

pH RESOLUTION

Press **CAL** when "rES" message is displayed on the secondary LCD. The set resolution ("0.1", "0.01" or "0.001") and "CFM" will start blinking.

Press the **ARROW** keys to toggle between 0.1, 0.01 and 0.001 options.



Press **CFM** to save the modified value.

Press **CAL** to escape without saving.

ION CHARGE

Press **CAL** when "IonC" is displayed. The ion charge ("UndF", "-2", "-1", "1" or "2") and "CFM" will start blinking.



Press the **ARROW** keys to change the ion charge.

Press **CFM** to save the modified ion charge.

Press **CAL** to escape without saving.

Note: To select the right ion charge, different ion types and their charge are presented in the table below.

ION CHARGE	ION types
-2 (divalent anions)	S
-1 (monovalent anions)	F, Cl, Br, I, CN, SCN, ClO ₂ , NO ₂ , NH ₃
1 (monovalent cations)	Na, K, Ag, NH ₄ , CO ₂
2 (divalent cations)	Mg, Ca, Ba, Cd, Cu, Pb
undF	undefined ion

CURRENT TIME

Press **CAL** when the current time is displayed. The hour and "CFM" will start blinking.



Press the **ARROW** keys to change the hour.

Press **RANGE**. The minutes and "CFM" will start blinking.



Press the **ARROW** keys to change the minutes.

Press **CFM** to save the modified value.

Press **CAL** to escape without saving.

CURRENT DATE

Press **CAL** when the current date is displayed. The year and "CFM" will start blinking.



Press the **ARROW** keys to change the year.

Press **RANGE**. The month and "CFM" will start blinking.



Press the **ARROW** keys to change the month.

Press **RANGE**. The day and "CFM" will start blinking.



Press the **ARROW** keys to change the day.

Press **CFM** to save the modified value.

Press **CAL** to escape without saving.

BEEP STATUS

Press **CAL** when the beep status is displayed. Beep status ("On" or "OFF") and "CFM" will start blinking.



Press the **ARROW** keys to change the beep status (On or OFF).

Press **CFM** to save the modified beep status.

Press **CAL** to escape without saving.

When enable, beep sounds as a short beep every time a key is pressed or when the calibration can be confirmed.

A long beep alert that the pressed key is not active or a wrong condition is detected while in calibration.

INSTRUMENT ID

Press **CAL** when the "InId" is displayed. The instrument ID ("0000" to "9999") and "CFM" will start blinking.



Press the **ARROW** keys to change the instrument ID value.

Press **CFM** to save the modified instrument ID value.

Press **CAL** to escape without saving.

Note: The instrument ID is downloaded to a PC as part of a logged data, set to identify its origin.

TEMPERATURE UNIT

Press **CAL** when "tnP" is displayed. The temperature unit and "CFM" will start blinking.



Press the **ARROW** keys to change the option.

Press **CFM** to save the modified temperature unit.

Press **CAL** to escape without saving.

TEMPERATURE CALIBRATION (for technical personnel only)

All the instruments are factory calibrated for temperature.

Hanna's temperature probes are interchangeable and no temperature calibration is needed when they are replaced.

If the temperature measurements are inaccurate, temperature recalibration should be performed.

For an accurate recalibration, contact your dealer or the nearest Hanna Customer Service Center, or follow the instructions below.

- Prepare a vessel containing ice and water and another one containing hot water (around 50 °C). Place insulation material around the vessels to minimize temperature changes.
- Use a calibrated thermometer with a resolution of 0.1 °C as a reference thermometer.
- With the instrument off, press and hold down the **CFM & SETUP** keys, then power on the instrument. The "CAL" tag will appear and the secondary LCD will show "0.0 °C".



- Submerge the temperature probe in the vessel with ice and water as near as possible to the reference thermometer. Allow a few seconds for the probe to stabilize.
- Use the **ARROW** keys to set the reading on the secondary LCD to that of ice and water, measured by the reference thermometer. When the reading is stable and close to the selected calibration point, "READY" tag will appear and "CFM" tag will blink.
- Press **CFM** to confirm. The secondary LCD will show "50.0 °C".

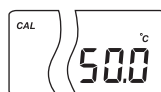

- Submerge the temperature probe in the second vessel as near as possible to the reference thermometer. Allow a few seconds for the probe to stabilize.

- Use the **ARROW** keys to set the reading on the secondary LCD to that of the hot water.



- When the reading is stable and close to the selected calibration point, “READY” tag will appear and “CFM” tag will blink.
- Press **CFM** to confirm. The instrument memorize calibration and restart to measurement mode.



Note: If the reading is not close to the selected calibration point, “WRONG” tag will blink. Change the temperature probe and restart calibration.

mV CALIBRATION (for technical personnel only)

All the instruments are factory calibrated for mV.

Hanna’s ORP electrodes are interchangeable and no mV calibration is needed when they are replaced.

If the mV measurements are inaccurate, mV recalibration should be performed.

For an accurate recalibration, contact your dealer or the nearest Hanna Customer Service Center, or follow the instructions below.

A two-point calibration can be performed at 0.0 mV and 1800.0 mV.

- Attach to the BNC connector a mV simulator with an accuracy of ± 0.1 mV.
- With the instrument off, press and hold down the **CAL & ▼ °C** keys, then power on the instrument. The “CAL” tag will appear and the secondary LCD will show “0.0 mV”.
- Set 0.0 mV on the simulator.

When the reading is stable and close to the selected calibration point, “READY” tag will appear and “CFM” tag will blink.

- Press **CFM** to confirm. The secondary LCD will display “1800 mV”.
- Set 1800.0 mV on the simulator.

When the reading is stable and close to the selected calibration point, “READY” tag will appear and “CFM” tag will blink.

- Press **CFM** to confirm. The instrument memorize calibration and restart to measurement mode.

- Notes:**
- If the reading is not close to the selected calibration point, “**WRONG**” tag will blink. Verify calibration condition or contact your vendor if you can not calibrate.
 - Pressing **CAL** key during temperature or mV calibration the instrument quit calibration mode and restart to measurement mode without memorizing calibration.

PC INTERFACE

Data transmission from the instrument to the PC can be done with the **HI 92000** Windows® compatible software (optional). **HI 92000** also offers graphing and an on-line help feature.

Data can be exported to the most popular spreadsheet programs for further analysis.

To connect your instrument to a PC, use a standard USB cable connector. Make sure that your instrument is switched off and plug one connector to the instrument’s USB socket and the other to the USB port of your PC.

Note: If you are not using Hanna Instruments **HI 92000** software, please see the following instructions.

SENDING COMMANDS FROM PC

It is also possible to remotely control the instrument with any terminal program. Use a standard USB cable to connect the instrument to a PC, start the terminal program and set the communication options as follows: 8, N, 1, no flow control, 9600 baud rate.

COMMAND TYPES

To send a command to the instrument follow the next scheme:

<command prefix> <command> <CR>

where: <command prefix> is a 16 ASCII character
<command> is the command code.

Note: Either small or capital letters can be used.

SIMPLE COMMANDS

RNG	Is equivalent to pressing RANGE
CAL	Is equivalent to pressing CAL
CFM	Is equivalent to pressing CFM
UPC	Is equivalent to pressing the UP arrow key
DWC	Is equivalent to pressing the DOWN arrow key
LOG	Is equivalent to pressing LOG
RCL	Is equivalent to pressing RCL
SET	Is equivalent to pressing SETUP

CHR xx Change the instrument range according with the parameter value (xx):

- xx=00 pH range/0.001 resolution
- xx=01 pH range/0.01 resolution
- xx=02 pH range/0.1 resolution
- xx=03 mV range
- xx=04 Relative mV range
- xx=05 ISE range

The instrument will answer for these commands with:

<STX> <answer> <ETX>

where: <STX> is 02 ASCII code character (start of text)

<ETX> is 03 ASCII code character (end of text)

<answer>:

<ACK> is 06 ASCII code character (recognized command)

<NAK> is 21 ASCII code character (unrecognized command)

<CAN> is 24 ASCII code character (corrupted command)

COMMANDS REQUIRING AN ANSWER

The instrument will answer for these commands with:

<STX> <answer> <checksum> <ETX>

where the checksum is the bytes sum of the answer string sent as 2 ASCII characters.

All the answer messages are with ASCII characters.

RAS Causes the instrument to send a complete set of readings in according with the current range:

- pH, temperature and mV reading on pH range.
- Rel mV, absolute mV and temperature reading on Relative mV range.
- ISE, mV and temperature reading on ISE range.

The answer string contains:

- Meter mode (2 chars):
 - 00 - pH range (0.001 resolution)
 - 01 - pH range (0.01 resolution)
 - 02 - pH range (0.1 resolution)
 - 03 - mV range
 - 04 - Rel mV range
 - 05 - ISE range

- Meter status (2 chars of status byte): represents a 8 bit hexadecimal encoding.
 - 0x10 - temperature probe is connected
 - 0x01 - new GLP data available
 - 0x02 - new SETUP parameter
- Reading status (2 chars): R - in range, O - over range, U - under range. First character corresponds to the appropriate range reading. Second character corresponds to mV reading.
- Primary reading (corresponding to the selected range) - 7 ASCII chars, including sign and decimal point.
- Secondary reading (only when primary reading is not mV) - 7 ASCII chars, including sign and decimal point.
- Temperature reading - 8 ASCII chars, with sign and two decimal points, always in °C.

MDR Requests the instrument model name and firmware code (16 ASCII chars).

GLP Requests the calibration data record.

The answer string contains:

- GLP status (1 char): represents a 4 bit hexadecimal encoding.
 - 0x01 - pH calibration available
 - 0x02 - Rel mV calibration available
 - 0x04 - ISE calibration available
- pH calibration data (if available), which contains:
 - the number of calibrated buffers (1 char)
 - the ion charge, with sign (2 chars)
 - the offset, with sign and decimal point (7 chars)
 - the average of slopes, with sign and decimal point (7 chars)
 - the calibration time, **yymmddhhmmss** (12 chars)
 - buffers information (for each buffer)
 - type (1 char): 0 - standard, 1 - custom
 - status (1 char): N (new) - calibrated in last calibration; O (old) - from an old calibration.
 - warnings during calibration (2 chars): 00 - no warning, 04 - Clean Electrode warning.
 - buffer value, with sign and decimal point (7 chars).

- the calibration time, **yymmddhhmmss** (12 chars).
- electrode condition, with sign (3 chars). The “-01” code means not calculated.
- Rel mV calibration data (if available), which contains:
 - the calibration offset, with sign (7 chars)
 - the calibration time, **yymmddhhmmss** (12 chars).
- ISE calibration data (if available), which contains:
 - the number of calibrated standards (1 char)
 - the ion charge, with sign (0 means undefined) (2 chars)
 - the calibration slope, with sign and decimal point (7 chars)
 - the calibration time, **yymmddhhmmss** (12 chars)
 - standards information (for each standard)
 - type (1 char): 0 - always standard solution.
 - status (1 char): N (new) - calibrated in last calibration; O (old) - from an old calibration.
 - warnings during calibration (2 chars): 00 - no warning.
 - standard value, with sign and decimal point (7 chars).
 - calibration time, **yymmddhhmmss** (12 chars).

PAR Requests the setup parameters setting.

The answer string contains:

- Instrument ID (4 chars)
- Calibration alarm time out for pH range (2 chars)
- Calibration alarm time out for ISE range (2 chars)
- SETUP information (2 chars): 8 bit hexadecimal encoding.
 - 0x01 - beep ON (else OFF)
 - 0x04 - degrees Celsius (else degrees Fahrenheit)
 - 0x08 - Offset calibration (else Point calibration)
- The number of custom buffers (1 char)
- The custom buffer values, with sign and decimal point, for each defined custom buffer (7 chars)
- Ion charge (2 chars)

NSLx Requests the number of logged samples (4 chars).

Command Parameter (1 char):

x - range (see Note)

LODPxxx Requests the xxxth pH record logged data.
LODMxxx Requests the xxxth mV/Rel mV record logged data.
LODIxxx Requests the xxxth ISE record logged data.
LODPALLff Requests all pH Log on demand - ff=frame number
LODMALLff Requests all mV/Rel mV Log on demand - ff=frame number
LODIALLff Requests all ISE Log on demand - ff=frame number

Note: The log on demand can be downloaded in frames of 8 records (01 is first frame number)

LLSxff: Requests information about all lots in frames of 10 lots (a frame contains information about 10 lots)

Command Parameters:

- x - range (see Note)
- ff - requested frame number - first frame is labeled 01

GLDxxxff: Requests the records of the "xxx" lot number. The records are sent in frames of 10 records; "ff" is the frame number (01 first frame). (Example: Lot 13 has 53 records. The records will be sent in 6 frame, 5 with 10 records and 1 with 3 records.)

Command Parameters:

- xxx - Lot number (eq: for lot number 1 xxx = 001)
- ff - requested frame number - first frame is labeled 01

- Errors:**
- "Err3" is sent if the Log on demand is empty.
 - "Err4" is sent if the requested set parameter is not available.
 - "Err5" is sent if an argument of the command is not correct.
 - "Err6" is sent if the requested range is not available.
 - "Err7" is sent if the instrument is in logging mode.
 - "Err8" is sent if the instrument is not in measurement mode.
 - Invalid commands will be ignored.

Note: P - request for pH range.
 M - request for mV and Rel mV ranges.
 I - request for ISE range.

ELECTRODE CONDITIONING & MAINTENANCE

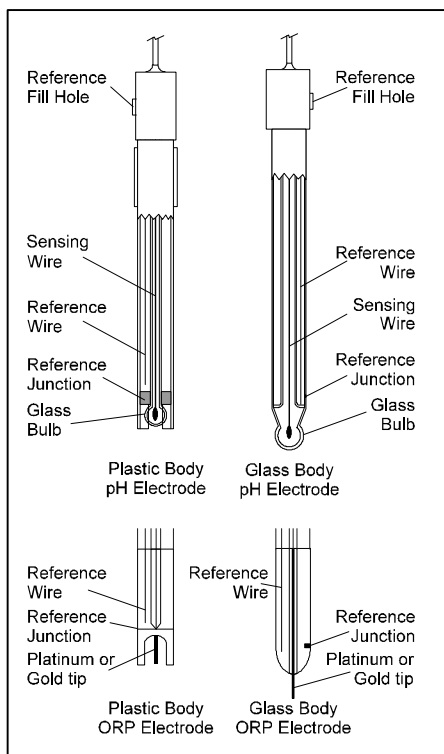

PREPARATION PROCEDURE

Remove the protective cap of the pH electrode.

DO NOT BE ALARMED IF SALT DEPOSITS ARE PRESENT. This is normal with electrodes. They will disappear when rinsed with water.

During transport, tiny bubbles of air may form inside the glass bulb affecting proper functioning of the electrode. These bubbles can be removed by “shaking down” the electrode as you would do with a glass thermometer.

If the bulb and/or junction is dry, soak the electrode in **HI 70300** or **HI 80300** Storage Solution for at least one hour.

For refillable electrodes:

If the filling solution (electrolyte) is more than 2½ cm (1") below the fill hole, add **HI 7082** or **HI 8082** 3.5M KCl Electrolyte Solution for double junction or **HI 7071** or **HI 8071** 3.5M KCl + AgCl Electrolyte Solution for single junction electrodes.

For faster response, unscrew the fill hole screw during measurements.

For AMPHEL® electrodes:

If the electrode does not respond to pH changes, the battery is run down and the electrode should be replaced.

MEASUREMENT

Rinse the electrode tip with distilled water. Submerge the tip (3 cm / 1¼") in the sample and stir gently for a few seconds.

For a faster response and to avoid cross-contamination of the samples, rinse the electrode tip with a few drops of the solution to be tested, before taking measurements.

STORAGE PROCEDURE

To minimize clogging and assure a quick response time, the glass bulb and the junction should be kept moist and not allowed to dry out.

Replace the solution in the protective cap with a few drops of **HI 70300** or **HI 80300** Storage Solution or, in its absence, Filling Solution (**HI 7071** or **HI 8071** for single junction and **HI 7082** or **HI 8082** for double junction electrodes). Follow the Preparation Procedure before taking measurements.

Note: NEVER STORE THE ELECTRODE IN DISTILLED OR DEIONIZED WATER.

PERIODIC MAINTENANCE

Inspect the electrode and the cable. The cable used for connection to the instrument must be intact and there must be no points of broken insulation on the cable or cracks on the electrode stem or bulb. Connectors must be perfectly clean and dry. If any scratches or cracks are present, replace the electrode. Rinse off any salt deposits with water.

For refillable electrodes:

Refill the reference chamber with fresh electrolyte (**HI 7071** or **HI 8071** for single junction and **HI 7082** or **HI 8082** for double junction electrodes).

Allow the electrode to stand upright for 1 hour.

Follow the Storage Procedure above.

CLEANING PROCEDURE

- General Soak in Hanna **HI 7061** or **HI 8061** General Cleaning Solution for approximately ½ hour.
- Protein Soak in Hanna **HI 7073** or **HI 8073** Protein Cleaning Solution for 15 minutes.
- Inorganic Soak in Hanna **HI 7074** Inorganic Cleaning Solution for 15 minutes.
- Oil/grease Rinse with Hanna **HI 7077** or **HI 8077** Oil and Fat Cleaning Solution.

IMPORTANT: After performing any of the cleaning procedures, rinse the electrode thoroughly with distilled water, refill the reference chamber with fresh electrolyte (not necessary for gel-filled electrodes) and soak the electrode in **HI 70300** or **HI 80300** Storage Solution for at least 1 hour before taking measurements.

TROUBLESHOOTING GUIDE

SYMPTOMS	PROBLEM	SOLUTION
Slow response/excessive drift.	Dirty pH electrode.	Clean the electrode and then soak the tip in HI 7061 or HI 8061 for 30 minutes.
Readings fluctuate up and down (noise).	Clogged/dirty junction. Low electrolyte level (refillable electrodes only).	Clean the electrode. Refill with fresh solution (for refillable electrodes only). Check cable and connectors.
The meter does not accept the buffer solution for calibration.	Dirty electrode or contaminated buffer.	Follow the cleaning procedure. If still no results, replace the electrode. Replace buffer.
If the display shows: "pH" and "-2.00" or "16.00" blinking.	Out of range in the pH scale.	a) Verify that the electrode is connected. b) Verify that the shipping cap has been removed. c) Recalibrate the meter. d) Make sure the pH sample is in the specified range. e) Check electrolyte level and general state of the electrode.
If the display shows: "mV" and "-2000" or "2000" blinking	Out of range in the mV scale.	Verify that the electrode is connected.
The meter does not work with the temperature probe.	Broken temperature probe. Wrong temperature probe used.	Replace the temperature probe.
The meter fails to calibrate or gives faulty readings.	Broken pH electrode.	Replace the electrode.
At startup the meter displays all LCD tags permanently.	One of the keys is stuck.	Check the keyboard or contact the vendor.
"Err xx" error message displayed.	Internal error.	Power off the meter and then power it on. If the error persists, contact the vendor.

TEMPERATURE CORRELATION FOR pH SENSITIVE GLASS

The resistance of glass electrodes partially depends on the temperature. The lower the temperature, the higher the resistance. It takes more time for the reading to stabilize if the resistance is higher. In addition, the response time will suffer to a greater degree at temperatures below 25 °C.

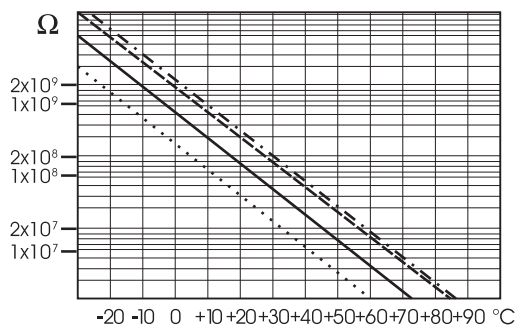

Since the resistance of the pH electrode is in the range of 50 – 200 Mohm, the current across the membrane is in the pico Ampere range. Large currents can disturb the calibration of the electrode for many hours.

For these reasons high humidity environments, short circuits and static discharges are detrimental to a stable pH reading.

The pH electrode's life also depends on the temperature. If constantly used at high temperatures, the electrode life is drastically reduced.

Typical Electrode Life

Ambient Temperature	1 – 3 years
90 °C	Less than 4 months
120 °C	Less than 1 month

Alkaline Error

High concentrations of sodium ions interfere with readings in alkaline solutions. The pH at which the interference starts to be significant depends upon the composition of the glass. This interference is called alkaline error and causes the pH to be underestimated. Hanna's glass formulations have the indicated characteristics.

Sodium Ion Correction for the Glass at 20-25 °C		
Concentration	pH	Error
0.1 Mol L ⁻¹ Na ⁺	13.00	0.10
	13.50	0.14
	14.00	0.20
1.0 Mol L ⁻¹ Na ⁺	12.50	0.10
	13.00	0.18
	14.00	0.40

ACCESSORIES

pH BUFFER SOLUTIONS

HI 70004P	pH 4.01 Buffer Sachets, 20 mL, 25 pcs
HI 70007P	pH 7.01 Buffer Sachets, 20 mL, 25 pcs
HI 70010P	pH 10.01 Buffer Sachets, 20 mL, 25 pcs
HI 7001L	pH 1.68 Buffer Solution, 500 mL
HI 7004L	pH 4.01 Buffer Solution, 500 mL
HI 7006L	pH 6.86 Buffer Solution, 500 mL
HI 7007L	pH 7.01 Buffer Solution, 500 mL
HI 7009L	pH 9.18 Buffer Solution, 500 mL
HI 7010L	pH 10.01 Buffer Solution, 500 mL
HI 8004L	pH 4.01 Buffer Solution in FDA approved bottle, 500 mL
HI 8006L	pH 6.86 Buffer Solution in FDA approved bottle, 500 mL
HI 8007L	pH 7.01 Buffer Solution in FDA approved bottle, 500 mL
HI 8009L	pH 9.18 Buffer Solution in FDA approved bottle, 500 mL
HI 8010L	pH 10.01 Buffer Solution in FDA approved bottle, 500 mL

ELECTRODE STORAGE SOLUTIONS

HI 70300L	Storage Solution, 500 mL
HI 80300L	Storage Solution in FDA approved bottle, 500 mL

ELECTRODE CLEANING SOLUTIONS

HI 70000P	Electrode Rinse Sachets, 20 mL, 25 pcs
HI 7061L	General Cleaning Solution, 500 mL
HI 7073L	Protein Cleaning Solution, 500 mL
HI 7074L	Inorganic Cleaning Solution, 500 mL
HI 7077L	Oil & Fat Cleaning Solution, 500 mL
HI 8061L	General Cleaning Solution in FDA approved bottle, 500 mL
HI 8073L	Protein Cleaning Solution in FDA approved bottle, 500 mL
HI 8077L	Oil & Fat Cleaning Solution in FDA approved bottle, 500 mL

ELECTRODE REFILL ELECTROLYTE SOLUTIONS

HI 7071	3.5M KCl + AgCl Electrolyte, 4x30 mL, for single junction electrodes
HI 7072	1M KNO ₃ Electrolyte, 4x30 mL
HI 7082	3.5M KCl Electrolyte, 4x30 mL, for double junction electrodes
HI 8071	3.5M KCl + AgCl Electrolyte in FDA approved bottle, 4x30 mL, for single junction electrodes
HI 8072	1M KNO ₃ Electrolyte in FDA approved bottle, 4x30 mL
HI 8082	3.5M KCl Electrolyte in FDA approved bottle, 4x30 mL, for double junction electrodes.

ORP PRETREATMENT SOLUTIONS

HI 7091L Reducing Pretreatment Solution, 500 mL

HI 7092L Oxidizing Pretreatment Solution, 500 mL

pH ELECTRODES

All electrodes part numbers ending in B are supplied with a BNC connector and 1 m (3.3') cable, as shown below :



HI 1043B

Glass-body, double junction, refillable, combination pH electrode.

Use: strong acid/alkali.

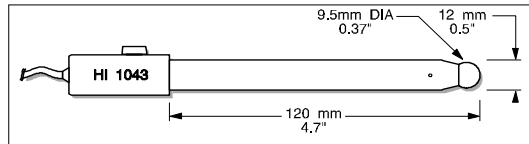

HI 1053B

Glass-body, triple ceramic, conic shape, refillable, combination pH electrode.

Use: emulsions.

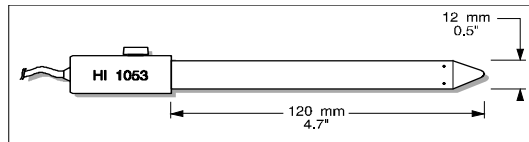

HI 1083B

Glass-body, micro, Viscolene, non-refillable, combination pH electrode.

Use: biotechnology, micro titration.

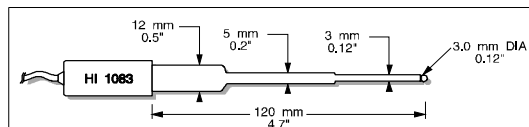

HI 1131B

Glass-body, single junction, refillable, combination pH electrode.

Use: general purpose.

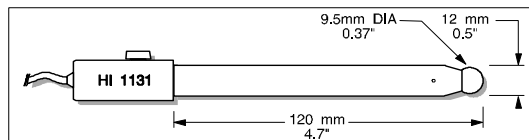

HI 1330B

Glass-body, semimicro, single junction, refillable, combination pH electrode.
Use: laboratory, vials.

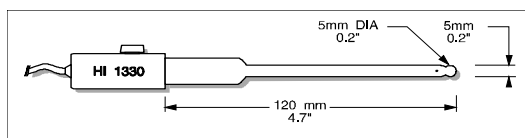

HI 1331B

Glass-body, semimicro, single junction, refillable, combination pH electrode.
Use: flasks.

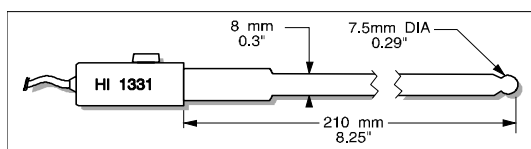

HI 1230B

Plastic-body (PES), double junction, gel-filled, combination pH electrode.
Use: general, field.

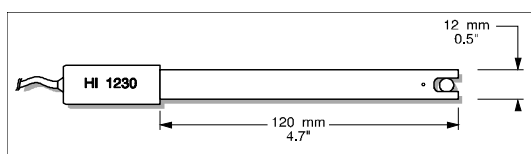

HI 2031B

Glass-body, semimicro, conic, refillable, combination pH electrode.
Use: semisolid products.

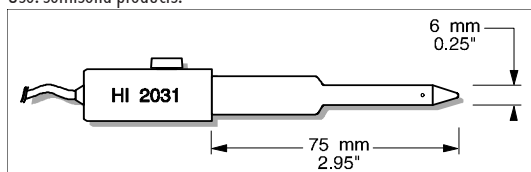

HI 1332B

Plastic-body (PES), double junction, refillable, combination pH electrode.
Use: general purpose.

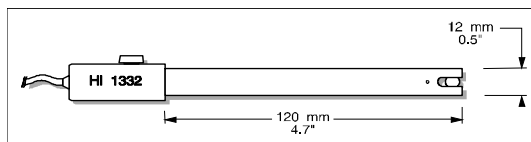

FC 100B

Plastic-body (PVDF), double junction, refillable, combination pH electrode.
Use: general purpose for food industry.

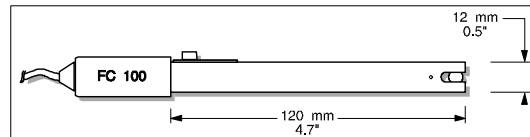

FC 200B

Plastic-body (PVDF), open junction, conic, Viscolene, non-refillable, combination pH electrode. Use: meat & cheese.

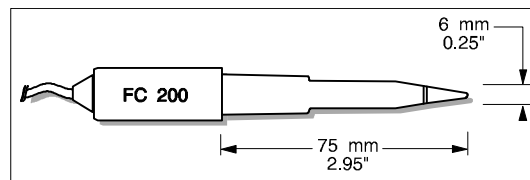

FC 210B

Glass-body, double junction, conic, Viscolene, non-refillable, combination pH electrode. Use: milk, yogurt.

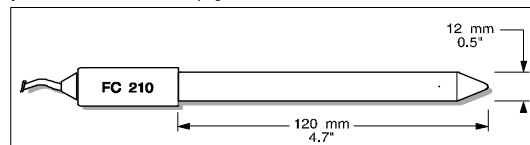

FC 220B

Glass-body, triple-ceramic, single junction, refillable, combination pH electrode. Use: food processing.

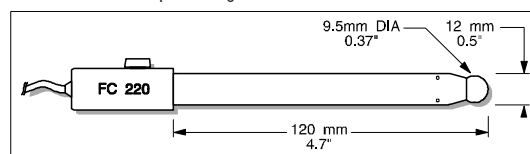

FC 911B

Plastic-body (PVDF), double junction, refillable with built-in amplifier, combination pH electrode. Use: very high humidity.

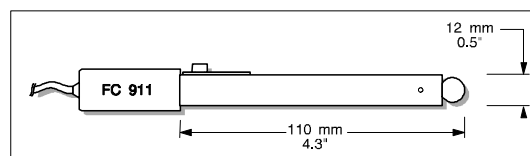

HI 1413B

Glass-body, single junction, flat tip, Viscolene, non-refillable, combination pH electrode. Use: surface measurement.

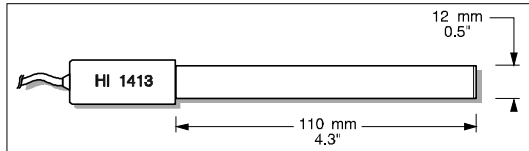

ORP ELECTRODES

HI 3131B

Glass-body, refillable, combination platinum ORP electrode.

Use: titration.

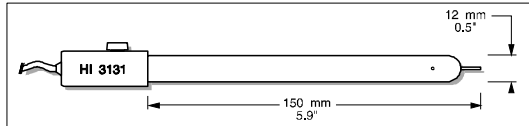

HI 3230B

Plastic-body (PES), gel-filled, combination platinum ORP electrode.

Use: general purpose.

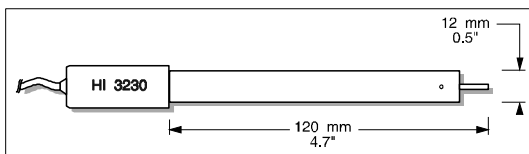

HI 4430B

Plastic-body (PES), gel-filled, combination gold ORP electrode.

Use: general purpose.

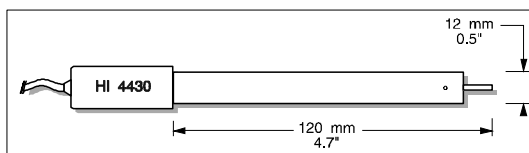

Consult the Hanna General Catalog for more electrodes with screw-type or BNC connectors.

EXTENSION CABLE FOR SCREW-TYPE ELECTRODES (SCREW TO BNC ADAPTER)

HI 7855/1 Extension cable 1 m (3.3') long

HI 7855/3 Extension cable 3 m (9.9') long

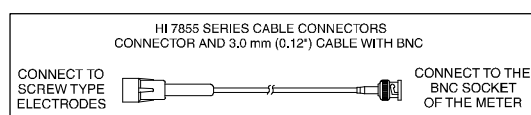

OTHER ACCESSORIES

HI 710005 Voltage adapter from 115 VAC to 12 VDC (USA plug)

HI 710006 Voltage adapter from 230 VAC to 12 VDC (European plug)

HI 710012 Voltage adapter from 240 VAC to 12 VDC (UK plug)

HI 710013 Voltage adapter from 230 VAC to 12 VDC (South Africa plug)

HI 710014 Voltage adapter from 230 VAC to 12 VDC (Australia plug)

HI 76404N Electrode holder

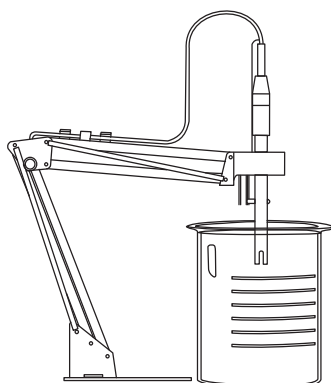

HI 8427 pH and ORP electrode simulator with 1 m (3.3') coaxial cable ending in female BNC connectors

HI 931001 pH and ORP electrode simulator with LCD and 1 m (3.3') coaxial cable ending in female BNC connectors

HI 7662 Temperature probe with 1 m (3.3') cable

HI 92000 Windows® compatible software.

Windows® is registered Trademark of "Microsoft Co."

RECOMMENDATIONS FOR USERS

Before using these products, make sure they are entirely suitable for the environment in which they are used.

Operation of these instruments in residential areas could cause unacceptable interferences to radio and TV equipment, requiring the operator to follow all necessary steps to correct interferences.

The glass bulb at the end of the pH electrode is sensitive to electrostatic discharges. Avoid touching this glass bulb at all times.

During operation, ESD wrist straps should be worn to avoid possible damage to the electrode by electrostatic discharges.

Any variation introduced by the user to the supplied equipment may degrade the instruments' EMC performance.

To avoid electrical shock, do not use these instruments when voltages at the measurement surface exceed 24 VAC or 60 VDC.

To avoid damage or burns, do not perform any measurement in microwave ovens.

Hanna Instruments reserves the right to modify the design, construction and appearance of its products without advance notice.



Hanna Instruments Inc.
Highland Industrial Park
584 Park East Drive
Woonsocket, RI 02895 USA

Technical Support for Customers
Tel. (800) 426 6287
Fax (401) 765 7575
E-mail tech@hannainst.com
www.hannainst.com

Local Sales and Customer Service Office

