

Instruction Manual

HI 83215

Grow Master Basic for Nutrient Analyses

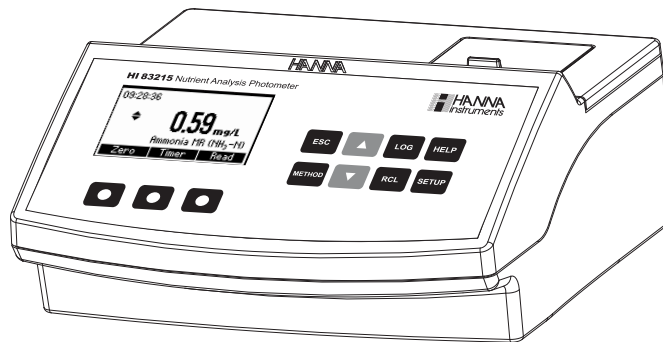

Dear Customer,

Thank you for choosing a Hanna product. Please read this instruction manual carefully before using the instrument. This manual will provide you with the necessary information for the correct use of the instrument. If you need additional technical information, do not hesitate to e-mail us at tech@hannainst.com.

TABLE OF CONTENTS

PRELIMINARY EXAMINATION	3
GENERAL DESCRIPTION	3
ABBREVIATIONS	4
SPECIFICATIONS	4
PRECISION AND ACCURACY	4
PRINCIPLE OF OPERATION	5
FUNCTIONAL DESCRIPTION	6
TIPS FOR AN ACCURATE MEASUREMENT	7
HEALTH & SAFETY	10
METHOD REFERENCE TABLE	11
OPERATIONAL GUIDE	11
SETUP	13
HELP MODE	15
INTRODUCTION	16
SAMPLE PREPARATION	19
AMMONIA HR	23
AMMONIA MR	25
AMMONIA LR	27
NITRATE HR	29
NITRATE MR	31
NITRATE LR	33
PHOSPHORUS HR	35
PHOSPHORUS MR	37
PHOSPHORUS LR	39
POTASSIUM HR	41
POTASSIUM MR	44
POTASSIUM LR	46
ERRORS AND WARNINGS	48
DATA MANAGEMENT	49
STANDARD METHODS	49
ACCESSORIES	50
WARRANTY	51
HANNA LITERATURE	51

All rights are reserved. Reproduction in whole or in part is prohibited without the written consent of the copyright owner, Hanna Instruments Inc., Woonsocket, Rhode Island, 02895, USA.

PRELIMINARY EXAMINATION

Please examine this product carefully. Make sure that the instrument is not damaged. If any damage occurred during shipment, please notify your local Hanna Office.

Each Meter is supplied complete with:

- Four Sample Cuvettes and Caps
- Sample Preparation Kit (see page 19)
- Cloth for wiping cuvettes (1 pcs)
- Scissors
- AC/DC Power Adapter
- Instruction Manual

The sample preparation kit contains:

- 4 cuvettes (10 mL) with caps
- 2 plastic beakers (100 and 170 mL)
- 1 graduated cylinder (100 mL)
- 1 syringe with screw rim (60 mL)
- 1 syringe (5 mL)
- 1 funnel
- 25 filter discs
- 1 spoon
- 2 pipettes
- Carbon powder packets (50 pcs)
- 1 Demineralizer Bottle with filter cap for about 12 liters of deionized water (depending on the hardness level of water to be treated)

Note: Save all packing material until you are sure that the instrument works correctly. Any defective item must be returned in its original packing with the supplied accessories.

GENERAL DESCRIPTION

HI 83215 is a multiparameter bench photometer dedicated for Nutrient analyses. It can measure 12 different methods using specific liquid or powder reagents. The amount of reagent is precisely dosed to ensure maximum reproducibility.

HI 83215 bench photometer can be connected to a PC via an USB cable. The optional **HI 92000** Windows® Compatible Software helps users manage all their results.

HI 83215 has a powerful interactive user support that assists the user during the analysis process.

Each step in the measurement process is help supported. A tutorial mode is available in the Setup Menu.

ABBREVIATIONS

°C:	degree Celsius
°F:	degree Fahrenheit
µg/L:	micrograms per liter (ppb)
mg/L:	milligrams per liter (ppm)
g/L:	grams per liter (ppt)
mL:	milliliter
HR:	high range
MR:	medium range
LR:	low range

SPECIFICATIONS

Light Life	Life of the instrument
Light Detector	Silicon Photocell
Environment	0 to 50°C (32 to 122°F); max 95% RH non-condensing
Power Supply	external 12 Vdc power adapter built-in rechargeable battery
Dimensions	235 x 200 x 110 mm (9.2 x 7.87 x 4.33")
Weight	0.9 Kg

For specifications related to each method (e.g. range, resolution, etc.) refer to the related measurement section.

PRECISION AND ACCURACY

Precision is how closely repeated measurements agree with each other. Precision is usually expressed as standard deviation (SD).

Accuracy is defined as the nearness of a test result to the true value.

Although good precision suggests good accuracy, precise results can be inaccurate. The figure explains these definitions.

For each method, the precision is expressed in the related measurement section.

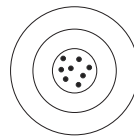

Precise, accurate

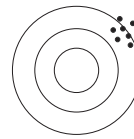

Precise, not accurate

Not precise, accurate

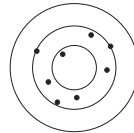

Not precise, not accurate

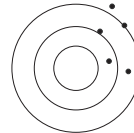

PRINCIPLE OF OPERATION

Absorption of light is a typical phenomenon of interaction between electromagnetic radiation and matter. When a light beam crosses a substance, some of the radiation may be absorbed by atoms, molecules or crystal lattices.

If pure absorption occurs, the fraction of light absorbed depends both on the optical path length through the matter and on the physical-chemical characteristics of substance according to the Lambert-Beer Law:

$$-\log I/I_0 = \epsilon_\lambda c d$$

or

$$A = \epsilon_\lambda c d$$

Where:

- log I/I_0 = Absorbance (A)
- I_0 = intensity of incident light beam
- I = intensity of light beam after absorption
- ϵ_λ = molar extinction coefficient at wavelength λ
- c = molar concentration of the substance
- d = optical path through the substance

Therefore, the concentration "c" can be calculated from the absorbance of the substance as the other factors are known.

Photometric chemical analysis is based on the possibility to develop an absorbing compound from a specific chemical reaction between sample and reagents.

Given that the absorption of a compound strictly depends on the wavelength of the incident light beam, a narrow spectral bandwidth should be selected as well as a proper central wavelength to optimize measurements.

The optical system of **HI 83215** is based on special subminiature tungsten lamps and narrow-band interference filters to guarantee both high performance and reliable results.

Three measuring channels allow a wide range of tests.

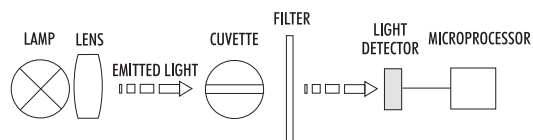

Instrument block diagram (optical layout)

A microprocessor controlled special tungsten lamp emits radiation which is first optically conditioned and beamed through the sample contained in the cuvette. The optical path is fixed by the diameter of the cuvette. Then the light is spectrally filtered to a narrow spectral bandwidth, to obtain a light beam of intensity I_0 or I .

The photoelectric cell collects the radiation I that is not absorbed by the sample and converts it into an electric current, producing a potential in the mV range.

The microprocessor uses this potential to convert the incoming value into the desired measuring unit and to display it on the LCD.

The measurement process is carried out in two phases: first the meter is zeroed and then the actual measurement is performed.

The cuvette has a very important role because it is an optical element and thus requires particular attention. It is important that both the measurement and the calibration (zeroing) cuvette are optically identical to provide the same measurement conditions. Most methods use the same cuvette for both, so it is important that measurements are taken at the same optical point. The instrument and the cuvette cap have special marks that must be aligned in order to obtain better reproducibility.

The surface of the cuvette must be clean and not scratched. This is to avoid measurement interference due to unwanted reflection and absorption of light. It is recommended not to touch the cuvette walls with hands.

Furthermore, in order to maintain the same conditions during the zeroing and the measurement phases, it is necessary to cap the cuvette to prevent any contamination.

FUNCTIONAL DESCRIPTION



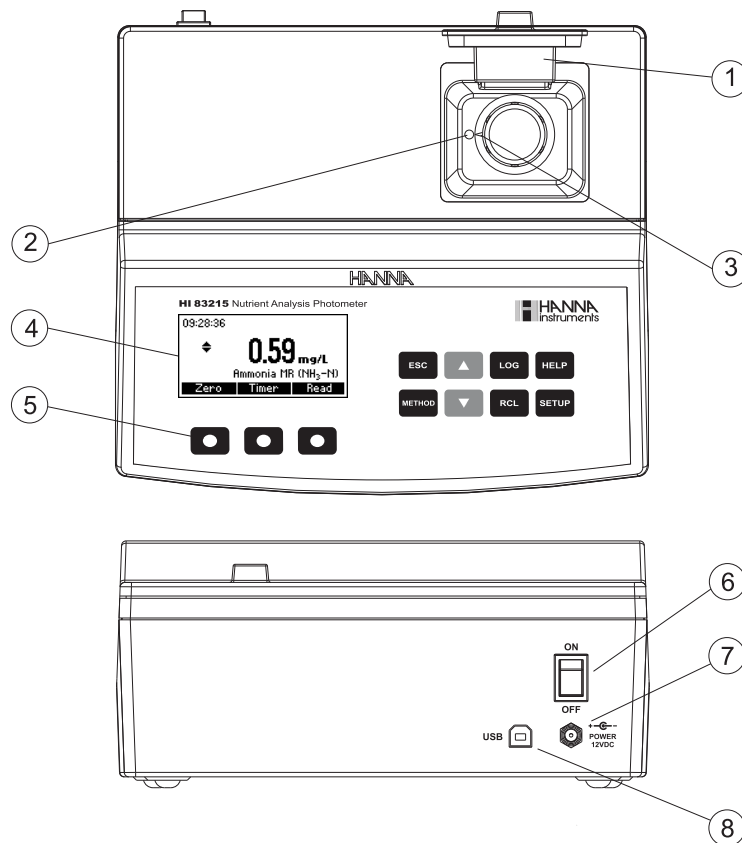





INSTRUMENT DESCRIPTION



- 1) Open Cuvette Lid
- 2) Indexing mark
- 3) Cuvette point
- 4) Liquid Crystal Display (LCD)
- 5) Splash proof keypad
- 6) ON/OFF power switch
- 7) Power input connector
- 8) USB connector

KEYPAD DESCRIPTION

The keypad contains 8 direct keys and 3 functional keys with the following functions:

-  Press to perform the function displayed above it on the LCD.
-  Press to exit the current screen.
-  Press to access the select method menu.
-  Press to move up in a menu or a help screen, to increment a set value, to access second level functions.
-  Press to move down in a menu or a help screen, to decrement a set value, to access second level functions.
-  Press to log the current reading.
-  Press to recall the log.
-  Press to display the help screen.
-  Press to access the setup screen.

TIPS FOR AN ACCURATE MEASUREMENT

The instructions listed below should be carefully followed during testing to ensure most accurate results.

- Color or suspended matter in large amounts may cause interference, and should be removed by treatment with active carbon and filtration: refer to the SAMPLE PREPARATION Chapter (see page 19)
- Ensure the cuvette is filled correctly: the liquid in the cuvette forms a convexity on the top; the bottom of this convexity must be at the same level as the 10 mL mark.

COLLECTING AND MEASURING SAMPLES

- In order to measure exactly 0.5 mL of reagent with the 1 mL syringe:
 - (a) push the plunger completely into the syringe and insert the tip into the solution.

- (b) pull the plunger up until the lower edge of the seal is exactly on the 0.0 mL mark.
- (c) take out the syringe and clean the outside of the syringe tip. Be sure that no drops are hanging on the tip of the syringe, if so eliminate them. Then, keeping the syringe in vertical position above the cuvette, push the plunger down into the syringe until the lower edge of the seal is exactly on the 0.5 mL mark. Now the exact amount of 0.5 mL has been added to the cuvette, even if the tip still contains some solution.

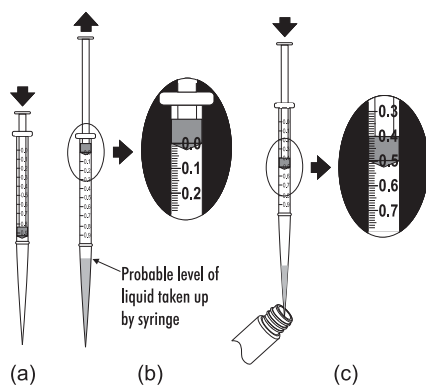

USING LIQUID AND POWDER REAGENTS

- Proper use of the dropper:
 - (a) for reproducible results, tap the dropper on the table for several times and wipe the outside of the dropper tip with a cloth.
 - (b) always keep the dropper bottle in a vertical position while dosing the reagent.

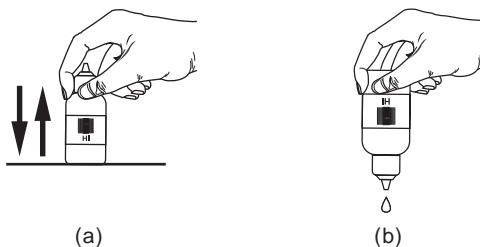

- Proper use of the powder reagent packet:
 - (a) use scissors to open the powder packet;
 - (b) push the edges of the packet to form a spout;
 - (c) pour out the content of the packet.

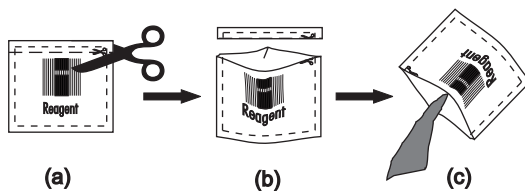

USING CUVETTES

- Proper mixing is very important for reproducibility of the measurements. The right way of mixing a cuvette is specified for each method in the related chapter.

- (a) **invert the cuvette** a couple of times or for a specified time: hold the cuvette in the vertical position. Turn the cuvette upside-down and wait for all of the solution to flow to the cap end, then return the cuvette to the upright vertical position and wait for all of the solution to flow to the cuvette bottom. This is one inversion. The correct speed for this mixing technique is 10-15 complete inversions in 30 seconds.

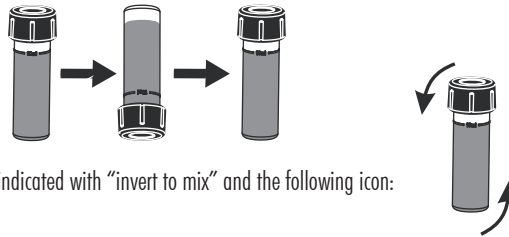

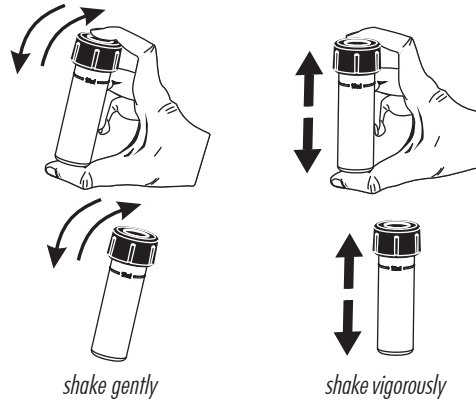

This mixing technique is indicated with “invert to mix” and the following icon:

- (b) **shaking the cuvette**, moving the cuvette up and down. The movement may be gentle or vigorous. This mixing method is indicated with “shake gently” or “shake vigorously”, and one of the following icons:

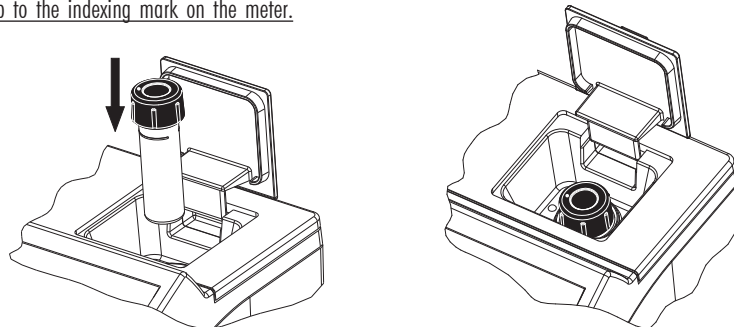

- Pay attention to push the cuvette completely down in the holder and to align the white point on the cap to the indexing mark on the meter.



- In order to avoid reagent leaking and to obtain more accurate measurements, close the cuvette first with the supplied HDPE plastic stopper  and then the black cap.
- Whenever the cuvette is placed into the measurement cell, it must be dry outside, and free of fingerprints, oil or dirt. Wipe it thoroughly with **HI 731318** or a lint-free cloth prior to insertion.
- Shaking the cuvette can generate bubbles in the sample, causing higher readings. To obtain accurate measurements, remove such bubbles by swirling or by gently tapping the cuvette.
- Do not let the reacted sample stand too long after reagent is added. For best accuracy, respect the timings described in each specific method.
- It is possible to take multiple readings in a row, but it is recommended to take a new zero reading for each sample and to use the same cuvette for zeroing and measurement when possible (for most precise results follow the measurement procedures carefully).
- Discard the sample immediately after the reading is taken, or the glass might become permanently stained.
- All the reaction times reported in this manual are at 25 °C (77 °F). In general, the reaction time should be increased for temperatures lower than 20 °C (68 °F), and decreased for temperatures higher than 25 °C (77 °F).

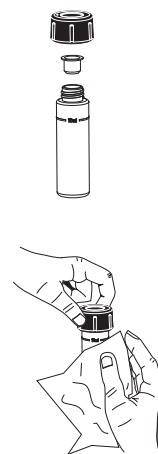

INTERFERENCES

- In the method measurement section the most common interferences that may be present in an average sample matrix have been reported. It may be that for a particular treatment process other compounds do interfere with the method of analysis.

HEALTH & SAFETY



- The chemicals contained in the reagent kits may be hazardous if improperly handled.
- Read the Material Safety Data Sheet (MSDS) before performing tests.
- Safety equipment: Wear suitable eye protection and clothing when required, and follow instructions carefully.
- Reagent spills: If a reagent spill occurs, wipe up immediately and rinse with plenty of water. If reagent contacts skin, rinse the affected area thoroughly with water. Avoid breathing released vapors.
- Waste disposal: for proper disposal of reagent kits and reacted samples, refer to the Material Safety Data Sheet (MSDS).

METHOD REFERENCE TABLE

Method	Method description	Page	Method	Method description	Page
1	Ammonia HR	23	7	Phosphorus HR	35
2	Ammonia MR	25	8	Phosphorus MR	37
3	Ammonia LR	27	9	Phosphorus LR	39
4	Nitrate HR	29	10	Potassium HR	41
5	Nitrate MR	31	11	Potassium MR	44
6	Nitrate LR	33	12	Potassium LR	46

OPERATIONAL GUIDE

POWER CONNECTION AND BATTERY MANAGEMENT

The meter can be powered from an AC/DC adapter (included) or from the built-in rechargeable battery.

Note: Always turn the meter off before unplugging it to ensure no data is lost.

When the meter switches ON, it verifies if the power supply adapter is connected. The battery icon on the LCD will indicate the battery status:

- battery is charging from external adapter
- battery fully charged (meter connected to AC/DC adapter)

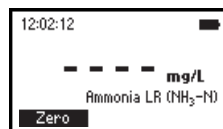
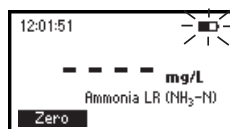

- battery capacity (no external adapter)
- battery Low (no external adapter)

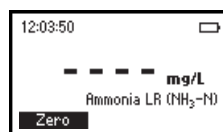
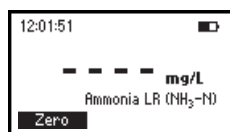

- battery Dead (no external adapter)

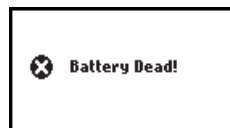

METHOD SELECTION

- Turn the instrument ON via the ON/OFF power switch.
- The meter will perform an autodiagnostic test. During this test, the Hanna Instrument logo will appear on the LCD. After 5 seconds, if the test was successful, the last method used will appear on the display.
- In order to select the desired method press the **METHOD** key and a screen with the available methods will appear.
- Press the ▲▼ keys to highlight the desired method. Press **Select**.

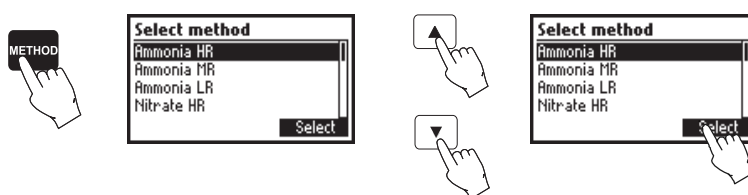

- After the desired method is selected, follow the measurement described in the related section.
- Before performing a test you should read all the instructions carefully.

DATA MANAGEMENT

The instrument features a data log function to help you keep track of all your analysis. The data log can hold 200 individual measurements. Storing, viewing and deleting the data is possible using the **LOG** and **RCL** keys.

Storing data: You can store only a valid measurement. Press **LOG** and the last valid measurement will be stored with date and time stamps.

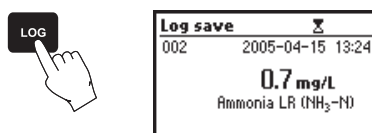

Viewing and deleting: You can view and delete the data log by pressing the **RCL** key. You can only delete the last saved measurement. Additionally, you can delete the data records all at once.

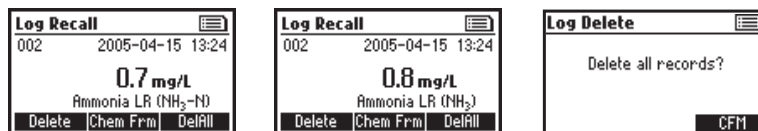

CHEMICAL FORM

Chemical form conversion factors are pre-programmed into the instrument and are method specific. In order to view the displayed result in the desired chemical form press ▲ or ▼ to access the second level functions and then press the **Chem Frm** key to toggle between the available chemical forms for the selected method.

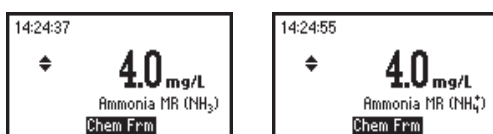

SETUP

In the Setup mode the instrument's parameters can be changed. Some parameters affect the measuring sequence and others are general parameters that change the behavior or appearance of the instrument.

Press **SETUP** to enter the setup mode.

Press **ESC** or **SETUP** to return to the main screen.

A list of setup parameters will be displayed with currently configured settings. Press **HELP** for additional information.

Press the ▲ ▼ keys to select a parameter and change the value as follows:



Backlight

Values: 0 to 8.

Press the **Modify** key to access the backlight value.

Use the ◀ ▶ functional keys or the ▲ ▼ keys to increase or decrease the value.

Press the **Accept** key to confirm or **ESC** to return to the setup menu without saving the new value.

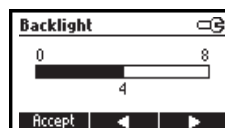
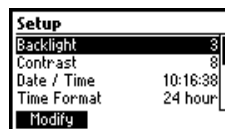

Contrast

Values: 0 to 20.

This option is used to set the display's contrast.

Press the **Modify** key to change the display's contrast.

Use the ◀ ▶ functional keys or the ▲ ▼ keys to increase or decrease the value.

Press the **Accept** key to confirm the value or **ESC** to return to the setup menu without saving the new value.

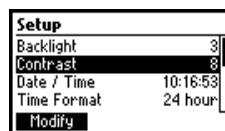

Date / Time

This option is used to set the instrument's date and time.

Press the **Modify** key to change the date/time.

Press the ◀ ▶ functional keys to highlight the value to be modified (year, month, day, hour, minute or second). Use the ▲ ▼ keys to change the value.

Press the **Accept** key to confirm or **ESC** to return to the setup without saving the new date or time.

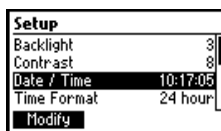

Time format

Option: AM/PM or 24 hour.

Press the functional key to select the desired time format.

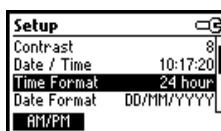

Date format

Press the **Modify** key to change the Date Format.

Use the ▲ ▼ keys to select the desired format.

Press the **Accept** key to confirm or **ESC** to return to the setup menu without saving the new format.

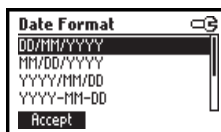
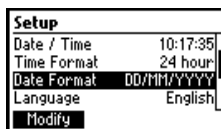

Language

Press the corresponding key to change the language.

If the new language cannot be loaded, the previously selected language will be reloaded.



Tutorial

Option: Enable or Disable.

If enabled this option will provide the user short guide related to the current screen.

Press the functional key to enable/disable the tutorial mode.

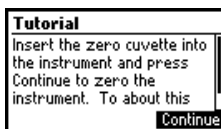
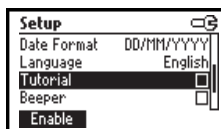

Beeper

Option: Enable or Disable.

When enabled, a short beep is heard every time a key is pressed. A long beep alert sounds when the pressed key is not active or an error condition is detected.

Press the functional key to enable/disable the beeper.

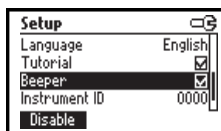

Instrument ID

Option: 0 to 9999.

This option is used to set the instrument's ID (identification number). The instrument ID is used while exchanging data with a PC.

Press the **Modify** key to access the instrument ID screen. Press the **▲ ▼** keys in order to set the desired value.

Press the **Accept** key to confirm the value or **ESC** to return to the setup menu without saving the new value.

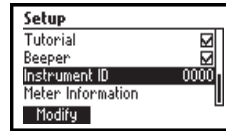

Meter information

Press the **Select** key to view the instrument model, firmware version, language version and instrument serial number.

Press **ESC** to return to the Setup mode.

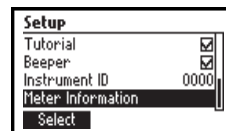

HELP MODE

HI 83215 offers an interactive contextual help mode that assists the user at any time.

To access the help screens press **HELP**.

The instrument will display additional information related to the current screen. To read all the available information, scroll the text using the **▲ ▼** keys.

Press the **Support** key to access a screen with Hanna service centers and their contact details.

Press the **Accessories** key to access a list of instrument reagents and accessories.

To exit support or accessories screens press **ESC** and the instrument will return to the previous help screen.

To exit help mode press the **HELP** or **ESC** key again and the meter will return to the previously selected screen.

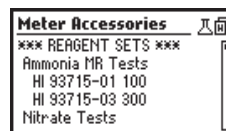
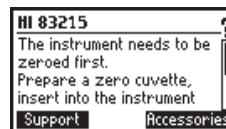

INTRODUCTION

THE ROLE OF NUTRIENTS IN THE GROWTH AND PRODUCTION OF PLANTS

The three elements that are mostly needed by the plants are nitrogen (N), phosphorus (P) and potassium (K). They are called the macronutrients while other elements, needed by plants in smaller amounts, are called microelements. In hydroponics, plants need a balanced nutritive solution, composed of macro and microelements.

Shortage or excess of even only one nutritive element may cause an imbalance in plant physiology and in the absorption of the other nutrients. Nutrients shortages may result in irregular plant growth, low resistance to diseases, scarce production both in quantity and quality, while nutrients excess may cause waste of fertilizer, pollution of the groundwater and the possible accumulation of dangerous substances in the crops produced.

NITROGEN

Nitrogen (N) is mostly absorbed by plants as nitrates (NO_3^-) and, in smaller amount, in the form of ammonium (NH_4^+). In hydroponics, an adequate ratio between the two forms is generally used in nutritive solutions.

<i>PRESENT IN</i>	proteins, enzymes, chlorophyll, hormones, vitamins, DNA and RNA
<i>ACTION</i>	<ul style="list-style-type: none"> • is fundamental for plants in phase of growth • promotes the lengthening of trunks and sprouts • increases the production of foliage • helps to absorb other nutrients (in particular phosphorus) • assists a bigger production for both size and number of fruits
<i>SHORTAGE EFFECTS</i>	<ul style="list-style-type: none"> • slower growth • smaller leaves • yellowing of leaves • smaller fruits • premature ripening
<i>EXCESS EFFECTS</i>	<ul style="list-style-type: none"> • reduction in resistance to diseases and atmospheric agents • increase of water demand (caused by an excessive production of leaves) • bad quality of fruits • delayed ripening • reduction in potassium absorption

PHOSPHORUS

Phosphorus (P) has an important role in many fundamental biochemical and physiological processes. Plants take up phosphorus in the form of phosphate ion (PO_4^{3-}).

<i>PRESENT IN</i>	DNA and RNA, ATP, ADP
<i>ACTION</i>	<ul style="list-style-type: none">• stimulates the roots growth• stimulates blooming• stimulates fecundation and ripeness• strengthens the plant tissues• is necessary in the formation of seeds
<i>SHORTAGE EFFECTS</i>	<ul style="list-style-type: none">• delayed ripening• slower growth• small leaves• decrease of production (smaller fruits and difficult seeds formation)• reduction of root system
<i>EXCESS EFFECTS</i>	<ul style="list-style-type: none">• premature ripening• excess of fruit-setting• negative effects on the absorption of some microelements such as iron, zinc, boron and copper

POTASSIUM

Potassium (K) is essential in proteic synthesis. The problem of lack of potassium is quite frequent in calcareous soils.

Potassium is absorbed as K^+ .

<i>PRESENT IN</i>	tissues responsible for the growth of plants (primary and secondary meristems), embryos and cell vacuole
<i>ACTION</i>	<ul style="list-style-type: none">• improves the quality of fruits and flowers• gives more resistance both to frost and to diseases caused by fungi (increases the cuticular thickness)• regulates the cellular turgidity (helps to regulate the osmotic processes and increases the resistance to dryness)• regulates the stomatic opening and closing (it means a strong influence on transpiration and photosynthesis)
<i>SHORTAGE EFFECTS</i>	<ul style="list-style-type: none">• slower growth• smaller fruits, less colored and less preserved• increase of transpiration• less resistance to the cold
<i>EXCESS EFFECTS</i>	<ul style="list-style-type: none">• reduced absorption of calcium and magnesium• increase of water consumption• increase of the substrate salinity

IRRIGATION WATER (LOW RANGE)

In agricultural areas it is quite common to find altered values in the chemical composition of irrigation waters. The problem concerns mostly the high nitrate concentration, usually determined by excessive fertilization or irrational liquid manure spreading. The analysis of irrigation waters allows us to find out which are the substances present in major or minor quantity and to organize an advantageous fertilization plan.

For example, if the quantity of water utilized for crop cultivation is 250 mm/ha (= 2500000 L/ha) and the nitrate (NO_3^-) concentration is 150 mg/L (34 mg/L as nitrate-nitrogen $\text{NO}_3\text{-N}$), soil receives 85 kg/ha of nitrogen. In choosing type and quantity of fertilizer to be used, it is important to consider this information, in order not to waste fertilizer nor to induce soil pollution.

NUTRIENTS SOLUTIONS (MEDIUM AND HIGH RANGE)

The nutrients requirements of the plants are determined by the type of plant, its age and the environmental conditions. The control of chemical composition of nutrients solutions given to the plants is an operation that allows a correct preparation of the fertilizer. In analyzing the solution, it is possible to choose between medium range and high range values, depending on the concentration of substances.

Medium range usually covers the analysis of residual solutions in recycling systems. The nutritive elements are differently absorbed by the plants, hence the nutrient solution loses substances, becomes impoverished and must be enriched.

High range normally corresponds to the typical values of nutrients solutions. It is therefore possible to verify that the solution given to the plants contains the correct quantities of nutritive substances.

SAMPLE PREPARATION

SAMPLE PREPARATION PROCEDURE

Note: If the water sample to be analyzed is very turbid, let it stand in a beaker for a while until most of the solid particles have settled. Then, use the pipette to transfer the supernatant solution to the other beaker and prepare the samples as described below. To prevent the displacement of the settled solids at the bottom of the beaker, do not induce air bubbles into the solution.

IRRIGATION WATER (LR):

- Measure 100 mL of sample with the graduated cylinder.

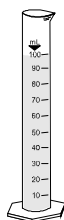

- If the solution contains some turbidity or color, pour it in the large 170 mL beaker and add a powder packet of active carbon.

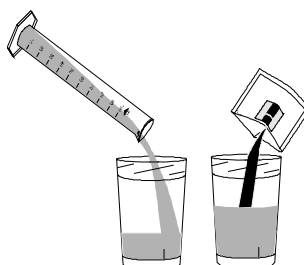

- Mix well using the spoon and then wait for 5 minutes.

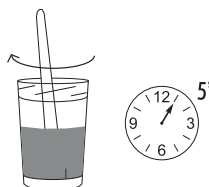

- Fold a filter disc twice as shown in the figure. Separate one side from the other three to form a cone. Insert the folded filter disc in the funnel.

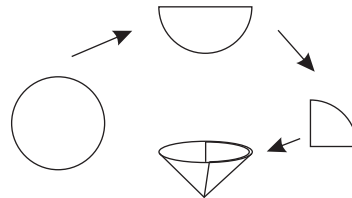

- Filter the treated sample into an empty beaker.
The sample is now ready.

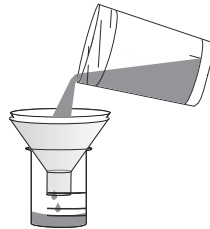

Note: Filter at least 40 mL of solution if all the four methods will be tested. If the solution is still turbid or colored, treat it again with a packet of active carbon. After use, throw the filter disc away and wash the syringe and the filter assembly well. Always use a new disc for another sample.

NUTRIENTS SOLUTION (MR):

- Use the graduated cylinder to measure exactly 20 mL of sample.

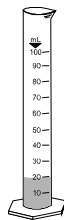

- Remove the cap and fill the Demineralizer Bottle with tap water.

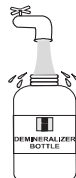

- Replace the cap and shake gently for at least 2 minutes.

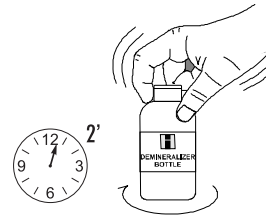

- Open the upper part of the Demineralizer Bottle cap and gently squirt the demineralized water into the cylinder, up to the 100 mL mark.
Note: The ion exchange resin contained in the Demineralizer Bottle is provided with an indicator substance. The indicator will change from green to blue when the resin has been exhausted and needs to be replaced.
- Pour the solution in the large 170 mL beaker, replace the cap and invert several times to mix.

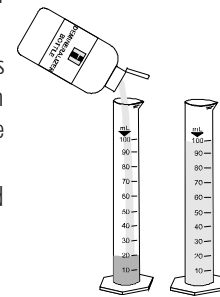
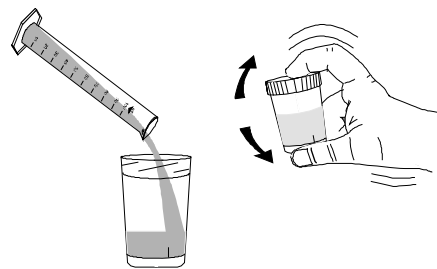

- If the solution contains some turbidity or color, add a powder packet of active carbon and follow the procedure described for **Irrigation Water (LR)**.

NUTRIENTS SOLUTION (HR):

- Add 10 mL of sample to the graduated cylinder using the 5 mL syringe (twice).

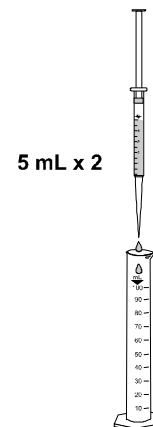

Note: To measure exactly 5 mL of sample with the syringe, push the plunger completely into the sample. Insert the tip into the sample. Pull the plunger out until the lower edge of the seal is on the 5 mL mark of the syringe.

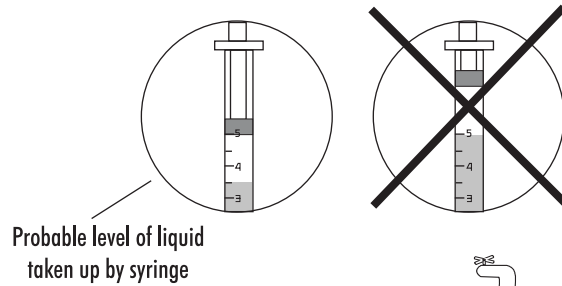

- Remove the cap and fill the Demineralizer Bottle with tap water.



- Replace the cap and shake gently for at least 2 minutes.

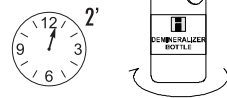

- Open the upper part of the Demineralizer Bottle cap and squirt gently the demineralized water into the cylinder, up to the 100 mL mark.

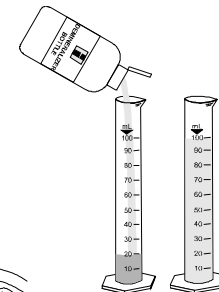

- Pour the solution in the large 170 mL beaker, replace the cap and invert several times to mix.

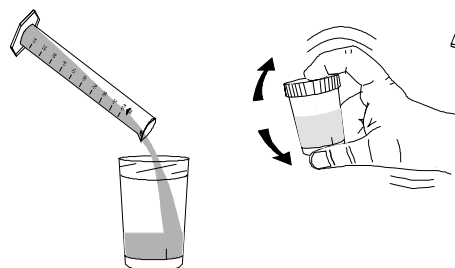

- If the solution contains some turbidity or color, add a powder packet of active carbon and follow the procedure described for **Irrigation Water (LR)**.

AMMONIA HIGH RANGE

SPECIFICATIONS

Range	0 to 100 mg/L
Resolution	1 mg/L
Accuracy	± 1 mg/L $\pm 4\%$ of reading at 25 °C
Typical EMC Deviation	± 1 mg/L
Light Source	Tungsten lamp with narrow band interference filter @ 420 nm
Method	Adaptation of the <i>ASTM Manual of Water and Environmental Technology, D1426-92</i> , Nessler method. The reaction between ammonia and reagents causes a yellow tint in the sample.

REQUIRED REAGENTS

<u>Code</u>	<u>Description</u>	<u>Quantity</u>
HI 93715A-0	First Reagent	4 drops (6 drops for seawater)
HI 93715B-0	Second Reagent	4 drops (10 drops for seawater)

REAGENT SETS

HI 93715-01 Reagents for 100 tests

HI 93715-03 Reagents for 300 tests

For other accessories see page 50.

MEASUREMENT PROCEDURE

ATTENTION:

Note: for sample preparation follow the **NUTRIENTS SOLUTION (HR)** procedure at page 21.

- Select the *Ammonia HR* method using the procedure described in the *Method Selection* section (see page 12).
- Fill the cuvette with 10 mL of unreacted sample (up to the mark) and replace the cap.
- Place the cuvette into the holder and close the lid.

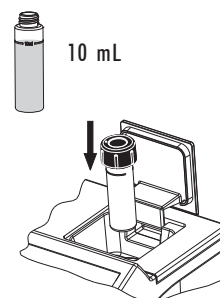

- Press the **Zero** key. The display will show “-0.0-” when the meter is zeroed and ready for measurement.

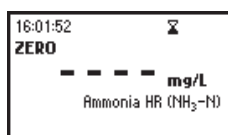
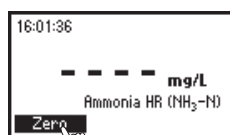

- Remove the cuvette.
- Add 4 drops of HI 93715A-0 First Reagent (6 drops for seawater analysis). Replace the cap and mix the solution by inverting the cuvette a couple of times.
- Add 4 drops of HI 93715B-0 Second Reagent (10 drops for seawater analysis). Replace the cap and mix the solution by inverting the cuvette a couple of times.
- Reinsert the cuvette into the instrument.
- Press **Timer** and the display will show the countdown prior to the measurement or, alternatively, wait for 3 minutes and 30 seconds and press **Read**. When the timer ends the meter will perform the reading. The instrument displays the results in mg/L of ammonia nitrogen ($\text{NH}_3\text{-N}$).

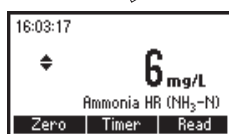
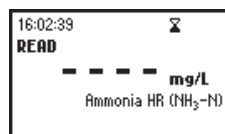
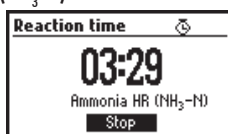
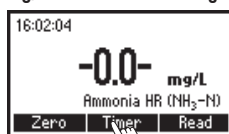
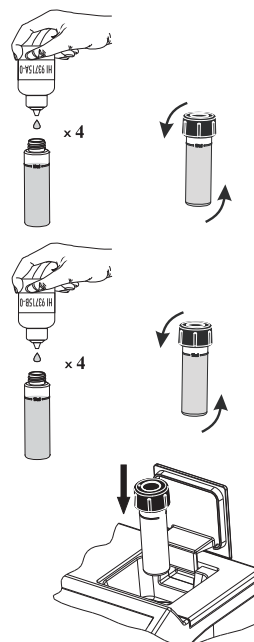

- Press ▲ or ▼ to access the second level functions.
- Press the **Chem Frm** key to convert the result in mg/L of ammonia (NH_3) and ammonium (NH_4^+).

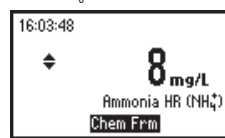
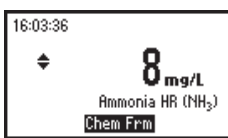
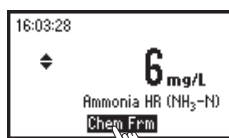

- Press ▲ or ▼ to return to the measurement screen.

INTERFERENCES

Interference may be caused by: acetone, alcohols, aldehydes, glycine, hardness above 1 g/L, iron, organic chloramines, sulfide, various aliphatic and aromatic amines.

AMMONIA MEDIUM RANGE

SPECIFICATIONS

Range	0.0 to 50.0 mg/L
Resolution	0.5 mg/L
Accuracy	± 0.5 mg/L $\pm 4\%$ of reading at 25 °C
Typical EMC	± 0.5 mg/L
Deviation	
Light Source	Tungsten lamp with narrow band interference filter @ 420 nm
Method	Adaptation of the <i>ASTM Manual of Water and Environmental Technology, D1426-92</i> , Nessler method. The reaction between ammonia and reagents causes a yellow tint in the sample.

REQUIRED REAGENTS

Code	Description	Quantity
HI 93715A-0	First Reagent	4 drops (6 drops for seawater)
HI 93715B-0	Second Reagent	4 drops (10 drops for seawater)

REAGENT SETS

HI 93715-01 Reagents for 100 tests

HI 93715-03 Reagents for 300 tests

For other accessories see page 50.

MEASUREMENT PROCEDURE

ATTENTION:

Note: for sample preparation follow the **NUTRIENTS SOLUTION (MR)** procedure at page 20.

- Select the *Ammonia MR* method using the procedure described in the *Method Selection* section (see page 12).
- Fill the cuvette with 10 mL of unreacted sample (up to the mark) and replace the cap.
- Place the cuvette into the holder and close the lid.

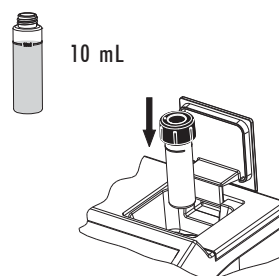

- Press the **Zero** key. The display will show “-0.0-” when the meter is zeroed and ready for measurement.

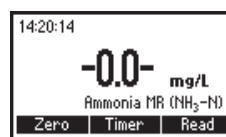
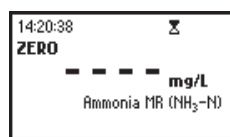
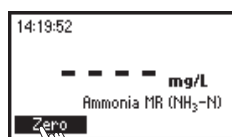

- Remove the cuvette.
- Add 4 drops of HI 93715A-0 First Reagent (6 drops for seawater analysis). Replace the cap and mix the solution by inverting the cuvette a couple of times.
- Add 4 drops of HI 93715B-0 Second Reagent (10 drops for seawater analysis). Replace the cap and mix the solution by inverting the cuvette a couple of times.
- Reinsert the cuvette into the instrument.
- Press **Timer** and the display will show the countdown prior to the measurement or, alternatively, wait for 3 minutes and 30 seconds and press **Read**. When the timer ends the meter will perform the reading. The instrument displays the results in mg/L of ammonia nitrogen ($\text{NH}_3\text{-N}$).

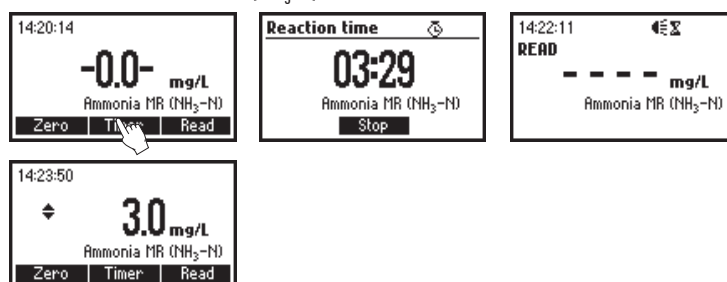
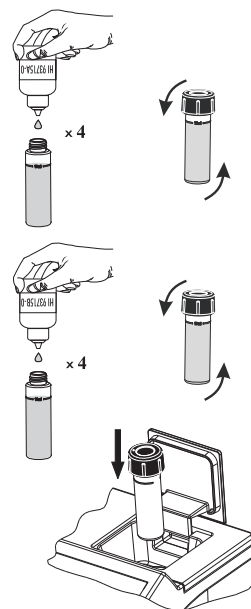

- Press **▲** or **▼** to access the second level functions.
- Press the **Chem Frm** key to convert the result in mg/L of ammonia (NH_3) and ammonium (NH_4^+).

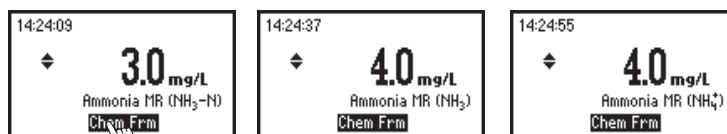

- Press **▲** or **▼** to return to the measurement screen.

INTERFERENCES

Interference may be caused by:

acetone, alcohols, aldehydes, glycine, hardness above 1 g/L, iron, organic chloramines, sulfide, various aliphatic and aromatic amines.

AMMONIA LOW RANGE

SPECIFICATIONS

Range	0.0 to 10.0 mg/L
Resolution	0.1 mg/L
Accuracy	± 0.1 mg/L $\pm 4\%$ of reading at 25 °C
Typical EMC	± 0.1 mg/L
Deviation	
Light Source	Tungsten lamp with narrow band interference filter @ 420 nm
Method	Adaptation of the <i>ASTM Manual of Water and Environmental Technology, D1426-92</i> , Nessler method. The reaction between ammonia and reagents causes a yellow tint in the sample.

REQUIRED REAGENTS

<u>Code</u>	<u>Description</u>	<u>Quantity</u>
HI 93715A-0	First Reagent	4 drops (6 drops for seawater)
HI 93715B-0	Second Reagent	4 drops (10 drops for seawater)

REAGENT SETS

HI 93715-01 Reagents for 100 tests

HI 93715-03 Reagents for 300 tests

For other accessories see page 50.

MEASUREMENT PROCEDURE

ATTENTION:

Note: for sample preparation follow the **IRRIGATION WATER (LR)** procedure at page 19.

- Select the *Ammonia LR* method using the procedure described in the *Method Selection* section (see page 12).
- Fill the cuvette with 10 mL of unreacted sample (up to the mark) and replace the cap.

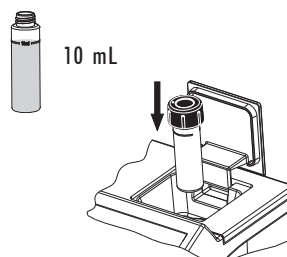

- Place the cuvette into the holder and close the lid.
- Press the **Zero** key. The display will show **"-0.0-"** when the meter is zeroed and ready for measurement.

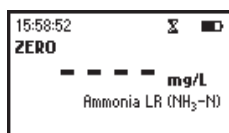
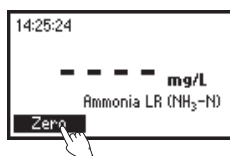

- Remove the cuvette.
- Add 4 drops of HI 93715A-0 First Reagent (6 drops for seawater analysis). Replace the cap and mix the solution by inverting the cuvette a couple of times.
- Add 4 drops of HI 93715B-0 Second Reagent (10 drops for seawater analysis). Replace the cap and mix the solution by inverting the cuvette a couple of times.
- Reinsert the cuvette into the instrument.
- Press **Timer** and the display will show the countdown prior to the measurement or, alternatively, wait for 3 minutes and 30 seconds and press **Read**. When the timer ends the meter will perform the reading. The instrument displays the results in **mg/L of ammonia nitrogen (NH₃-N)**.

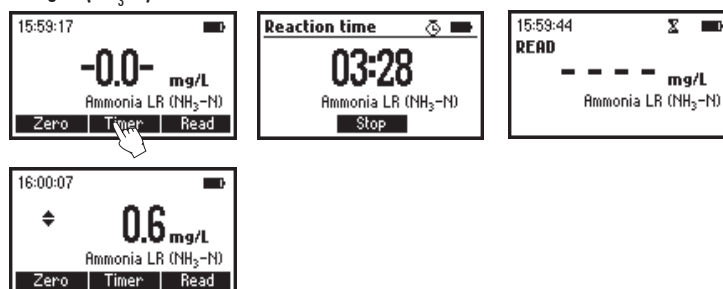
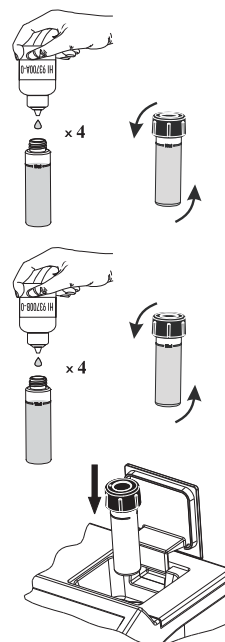

- Press ▲ or ▼ to access the second level functions.
- Press the **Chem Frm** key to convert the result in mg/L of ammonia (NH₃) and ammonium (NH₄⁺).

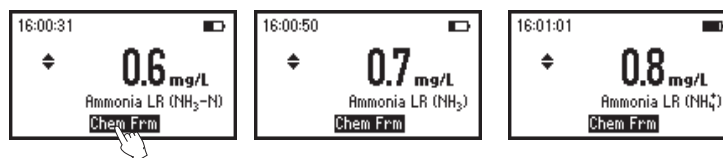

- Press ▲ or ▼ to return to the measurement screen.

INTERFERENCES

Interference may be caused by: acetone, alcohols, aldehydes, glycine, hardness above 1 g/L, iron, organic chloramines, sulfide, various aliphatic and aromatic amines.

NITRATE HIGH RANGE

SPECIFICATIONS

Range	0 to 300 mg/L
Resolution	5 mg/L
Accuracy	±10 mg/L ±8% of reading at 25 °C
Typical EMC Deviation	±5 mg/L
Light Source	Tungsten lamp with narrow band interference filter @ 525 nm
Method	Adaptation of the cadmium reduction method. The reaction between nitrate-nitrogen and the reagent causes an amber tint in the sample.

REQUIRED REAGENTS

Code	Description	Quantity
HI 93728-0	Powder reagent	1 packet

REAGENT SETS

HI 93728-01 Reagents for 100 tests

HI 93728-03 Reagents for 300 tests

For other accessories see page 50.

MEASUREMENT PROCEDURE

Note: for sample preparation follow the NUTRIENTS SOLUTION (HR) procedure at page 21.

- Select the *Nitrate HR* method using the procedure described in the *Method Selection* section (see page 12).
- Using the pipette, fill the cuvette with 6 ml of sample, up to half of its height, and replace the cap.
- Place the cuvette into the holder and close the lid.

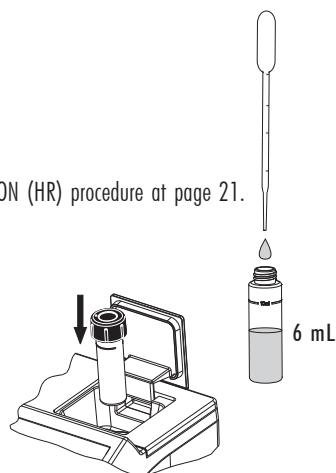

- Press the **Zero** key. The display will show “-0.0-” when the meter is zeroed and ready for measurement.

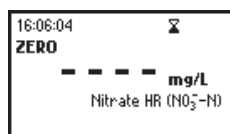
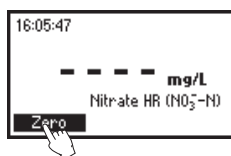

- Remove the cuvette and add the content of one packet of HI 93728-0 reagent.



- Replace the cap and immediately shake vigorously up and down for exactly 10 seconds. Continue to mix by inverting the cuvette gently for 50 seconds, while taking care not to induce air bubbles. Powder will not completely dissolve. Time and way of shaking could sensitively affect the measurement.
- Reinsert the cuvette into the instrument, taking care not to shake it.
- Press **Timer** and the display will show the countdown prior to the measurement or, alternatively, wait for 4 minutes and 30 seconds and press **Read**. When the timer ends the meter will perform the reading. The instrument displays the results in **mg/L of nitrate-nitrogen**.

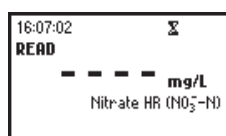
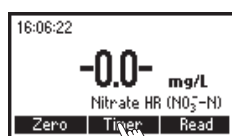
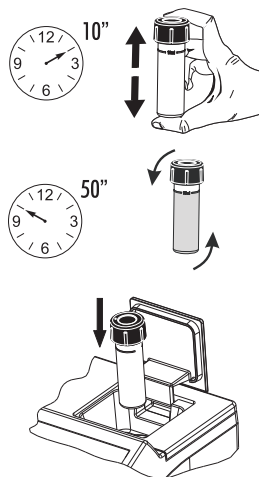

- Press ▲ or ▼ to access the second level functions.
- Press the **Chem Frm** key to convert the result in mg/L of nitrate (NO_3^-).



- Press ▲ or ▼ to return to the measurement screen.

INTERFERENCES

Interference may be caused by:

Ammonia and amines, as urea and primary aliphatic amines

Chloride above 100 ppm

Chlorine above 2 ppm

Copper

Iron(III)

Strong oxidizing and reducing substances

Sulfide must be absent

NITRATE MEDIUM RANGE

SPECIFICATIONS

Range	0 to 150 mg/L
Resolution	2.5 mg/L
Accuracy	± 5 mg/L $\pm 8\%$ of reading at 25 °C
Typical EMC Deviation	± 2.5 mg/L
Light Source	Tungsten lamp with narrow band interference filter @ 525 nm
Method	Adaptation of the cadmium reduction method. The reaction between nitrate-nitrogen and the reagent causes an amber tint in the sample.

REQUIRED REAGENTS

<u>Code</u>	<u>Description</u>	<u>Quantity</u>
HI 93728-0	Powder reagent	1 packet

REAGENT SETS

HI 93728-01 Reagents for 100 tests

HI 93728-03 Reagents for 300 tests

For other accessories see page 50.

MEASUREMENT PROCEDURE

Note: for sample preparation follow the NUTRIENTS SOLUTION (MR) procedure at page 20.

- Select the *Nitrate MR* method using the procedure described in the *Method Selection* section (see page 12).
- Using the pipette, fill the cuvette with 6 ml of sample, up to half of its height, and replace the cap.
- Place the cuvette into the holder and close the lid.

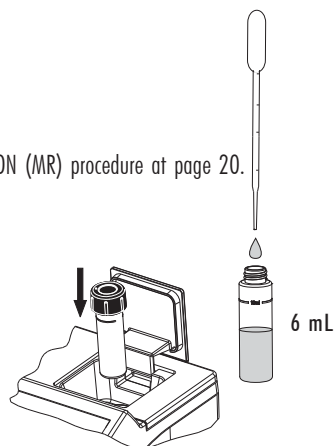

- Press the **Zero** key. The display will show “-0.0-” when the meter is zeroed and ready for measurement.

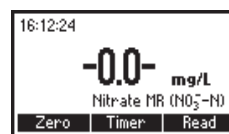
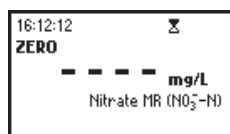
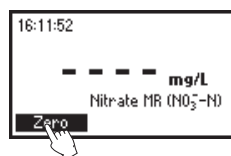

- Remove the cuvette and add the content of one packet of HI 93728-0 reagent.



- Replace the cap and immediately shake vigorously up and down for exactly 10 seconds. Continue to mix by inverting the cuvette gently for 50 seconds, while taking care not to induce air bubbles. Powder will not completely dissolve. Time and way of shaking could sensitively affect the measurement.
- Reinsert the cuvette into the instrument, taking care not to shake it.
- Press **Timer** and the display will show the countdown prior to the measurement or, alternatively, wait for 4 minutes and 30 seconds and press **Read**. When the timer ends the meter will perform the reading. The instrument displays the results in **mg/L of nitrate-nitrogen**.

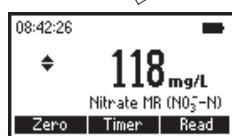
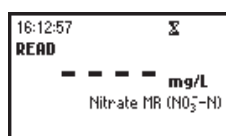
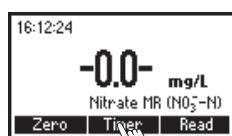
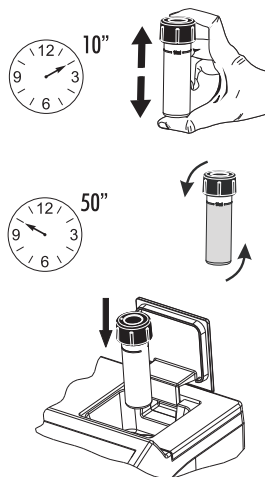

- Press **▲** or **▼** to access the second level functions.
- Press the **Chem Frm** key to convert the result in mg/L of nitrate (NO_3^-).

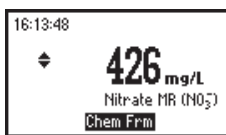
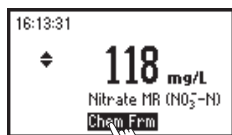

- Press **▲** or **▼** to return to the measurement screen.

INTERFERENCES

Interference may be caused by:

- Ammonia and amines, as urea and primary aliphatic amines
- Chloride above 100 ppm
- Chlorine above 2 ppm
- Copper
- Iron(III)
- Strong oxidizing and reducing substances
- Sulfide must be absent

NITRATE LOW RANGE

SPECIFICATIONS

Range	0.0 to 30.0 mg/L
Resolution	0.5 mg/L
Accuracy	± 1.0 mg/L $\pm 8\%$ of reading at 25 °C
Typical EMC	± 0.5 mg/L
Deviation	
Light Source	Tungsten lamp with narrow band interference filter @ 525 nm
Method	Adaptation of the cadmium reduction method. The reaction between nitrate-nitrogen and the reagent causes an amber tint in the sample.

REQUIRED REAGENTS

Code	Description	Quantity
HI 93728-0	Powder reagent	1 packet

REAGENT SETS

HI 93728-01 Reagents for 100 tests

HI 93728-03 Reagents for 300 tests

For other accessories see page 50.

MEASUREMENT PROCEDURE

Note: for sample preparation follow the IRRIGATION WATER (LR) procedure at page 19.

- Select the *Nitrate LR* method using the procedure described in the *Method Selection* section (see page 12).
- Using the pipette, fill the cuvette with 6 ml of sample, up to half of its height, and replace the cap.
- Place the cuvette into the holder and close the lid.
- Press the **Zero** key. The display will show “-0.0-” when the meter is zeroed and ready for measurement.

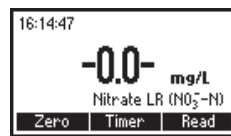
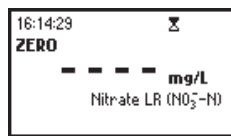
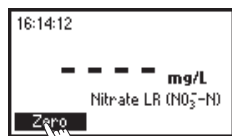
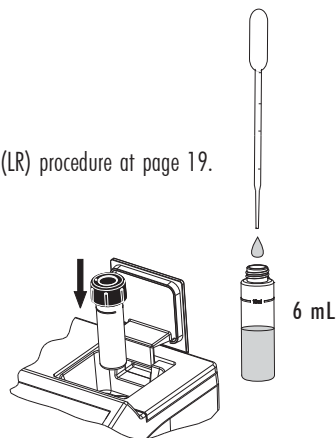

- Remove the cuvette and add the content of one packet of HI 93728-0 reagent.



- Replace the cap and immediately shake vigorously up and down for exactly 10 seconds. Continue to mix by inverting the cuvette gently for 50 seconds, while taking care not to induce air bubbles. Powder will not completely dissolve. Time and way of shaking could sensitively affect the measurement.
- Reinsert the cuvette into the instrument, taking care not to shake it.
- Press **Timer** and the display will show the countdown prior to the measurement or, alternatively, wait for 4 minutes and 30 seconds and press **Read**. When the timer ends the meter will perform the reading. The instrument displays the results in **mg/L of nitrate-nitrogen**.

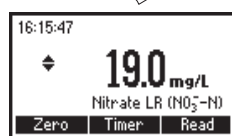
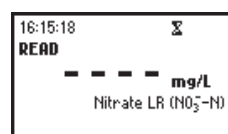
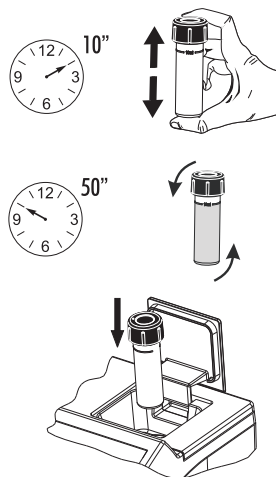

- Press **▲** or **▼** to access the second level functions.
- Press the **Chem Frm** key to convert the result in mg/L of nitrate (NO_3^-).

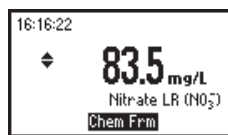

- Press **▲** or **▼** to return to the measurement screen.

INTERFERENCES

Interference may be caused by:

Ammonia and amines, as urea and primary aliphatic amines

Chloride above 100 ppm

Chlorine above 2 ppm

Copper

Iron(III)

Strong oxidizing and reducing substances

Sulfide must be absent

Nitrate LR

PHOSPHORUS HIGH RANGE

SPECIFICATIONS

Range	0 to 100 mg/L
Resolution	1 mg/L
Accuracy	± 5 mg/L ± 4% of reading at 25 °C
Typical EMC Dev.	± 1 mg/L
Light Source	Tungsten lamp with narrow band interference filter @ 525 nm
Method	Adaptation of the <i>Standard Methods for the Examination of Water and Wastewater, 18th edition</i> , Amino Acid method. The reaction between phosphorus and reagents causes a blue tint in the sample.

REQUIRED REAGENTS

<u>Code</u>	<u>Description</u>	<u>Quantity</u>
HI 93706A-0	Molybdate	10 drops
HI 93706B-0	Amino Acid Powder	1 packet

REAGENT SETS

HI 93706-01 Reagents for 100 tests

HI 93706-03 Reagents for 300 tests

For other accessories see page 50.

MEASUREMENT PROCEDURE

Note: for sample preparation follow the NUTRIENTS SOLUTION (HR) procedure at page 21.

- Select the *Phosphorus HR* method using the procedure described in the *Method Selection* section (see page 12).
- Fill the cuvette with 10 mL of unreacted sample (up to the mark) and replace the cap.
- Place the cuvette into the holder and close the lid.
- Press the **Zero** key. The display will show “-0.0-” when the meter is zeroed and ready for measurement.

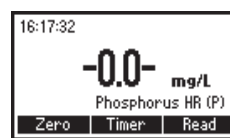
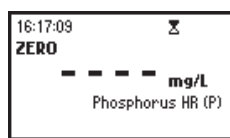
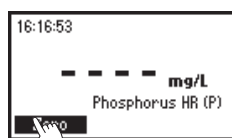
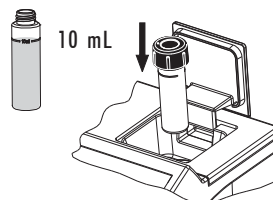

- Remove the cuvette.
- Add 10 drops of HI 93706A-0 Molybdate reagent.



- Add the content of one packet of HI 93706B-0 Phosphorus Reagent B (Amino Acid) to the cuvette. Replace the cap and shake gently until completely dissolved.

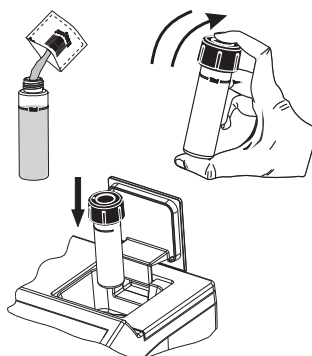

- Reinsert the cuvette into the instrument.

- Press **Timer** and the display will show the countdown prior to the measurement or, alternatively, wait for 5 minutes and press **Read**. When the timer ends the meter will perform the reading. The instrument displays the results in **mg/L of phosphorus (P)**.

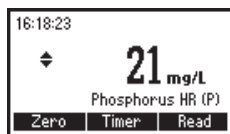
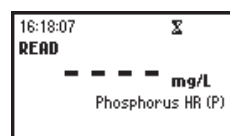
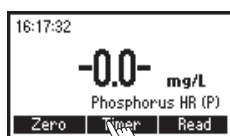

- Press ▲ or ▼ to access the second level functions.
- Press the **Chem Frm** key to convert the result in mg/L of phosphate (PO_4^{3-}) and phosphorus pentoxide (P_2O_5).

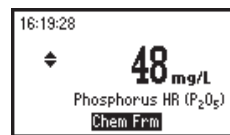
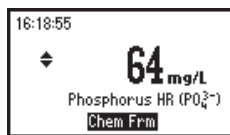
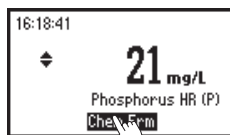

- Press ▲ or ▼ to return to the measurement screen.

INTERFERENCES

Interference may be caused by:

Sulfide

Chloride above 150000 mg/L

Calcium above 10000 mg/L as CaCO_3

Magnesium above 40000 mg/L as CaCO_3

Ferrous iron above 100 mg/L

Phosphorus HR

PHOSPHORUS MEDIUM RANGE

SPECIFICATIONS

Range	0.0 to 50.0 mg/L
Resolution	0.5 mg/L
Accuracy	± 2.5 mg/L $\pm 4\%$ of reading at 25 °C
Typical EMC Dev.	± 0.5 mg/L
Light Source	Tungsten lamp with narrow band interference filter @ 525 nm
Method	Adaptation of the <i>Standard Methods for the Examination of Water and Wastewater, 18th edition</i> , Amino Acid method. The reaction between phosphorus and reagents causes a blue tint in the sample.

REQUIRED REAGENTS

Code	Description	Quantity
HI 93706A-0	Molybdate	10 drops
HI 93706B-0	Amino Acid Powder	1 packet

REAGENT SETS

HI 93706-01 Reagents for 100 tests

HI 93706-03 Reagents for 300 tests

For other accessories see page 50.

MEASUREMENT PROCEDURE

Note: for sample preparation follow the NUTRIENTS SOLUTION (MR) procedure at page 20.

- Select the *Phosphorus* method using the procedure described in the *Method Selection* section (see page 12).
- Fill the cuvette with 10 mL of unreacted sample (up to the mark) and replace the cap.
- Place the cuvette into the holder and close the lid.
- Press the **Zero** key. The display will show “-0.0-” when the meter is zeroed and ready for measurement.

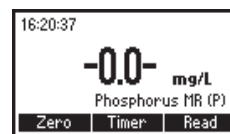
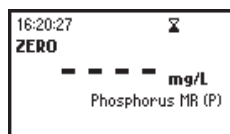
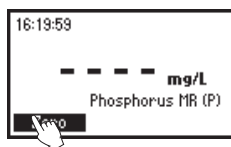
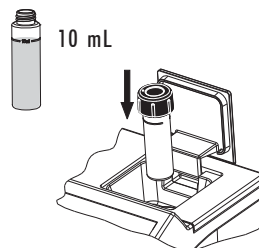

- Remove the cuvette.
- Add 10 drops of HI 93706A-0 Molybdate reagent.



- Add the content of one packet of HI 93706B-0 Phosphorus Reagent B (Amino Acid) to the cuvette. Replace the cap and shake gently until completely dissolved.

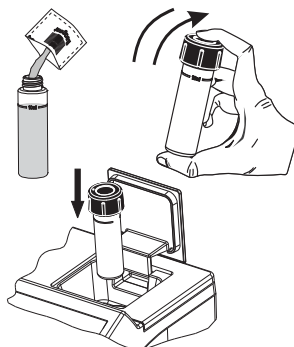

- Reinsert the cuvette into the instrument.

- Press **Timer** and the display will show the countdown prior to the measurement or, alternatively, wait for 5 minutes and press **Read**. When the timer ends the meter will perform the reading. The instrument displays the results in **mg/L of phosphorus (P)**.

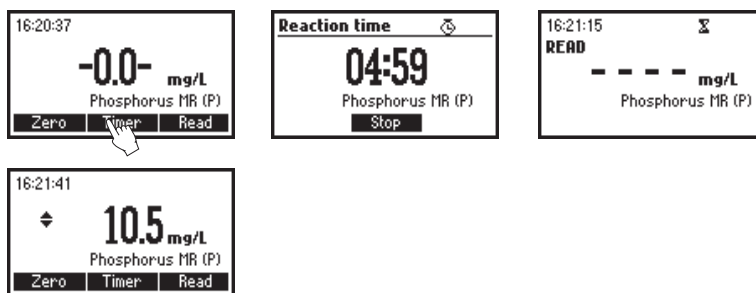

- Press ▲ or ▼ to access the second level functions.
- Press the **Chem Frm** key to convert the result in mg/L of phosphate (PO_4^{3-}) and phosphorus pentoxide (P_2O_5).

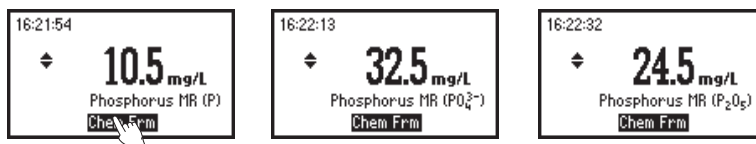

- Press ▲ or ▼ to return to the measurement screen.

INTERFERENCES

Interference may be caused by:

Sulfide

Chloride above 150000 mg/L

Calcium above 10000 mg/L as CaCO_3

Magnesium above 40000 mg/L as CaCO_3

Ferrous iron above 100 mg/L

PHOSPHORUS LOW RANGE

SPECIFICATIONS

Range	0.0 to 10.0 mg/L
Resolution	0.1 mg/L
Accuracy	±0.5 mg/L ±4% of reading at 25 °C
Typical EMC Dev.	±0.1 mg/L
Light Source	Tungsten lamp with narrow band interference filter @ 525 nm
Method	Adaptation of the <i>Standard Methods for the Examination of Water and Wastewater, 18th edition</i> , Amino Acid method. The reaction between phosphorus and reagents causes a blue tint in the sample.

REQUIRED REAGENTS

Code	Description	Quantity
HI 93706A-0	Molybdate	10 drops
HI 93706B-0	Amino Acid Powder	1 packet

REAGENT SETS

HI 93706-01 Reagents for 100 tests

HI 93706-03 Reagents for 300 tests

For other accessories see page 50.

MEASUREMENT PROCEDURE

Note: for sample preparation follow the IRRIGATION WATER (LR) procedure at page 19.

- Select the *Phosphorus* method using the procedure described in the *Method Selection* section (see page 12).
- Fill the cuvette with 10 mL of unreacted sample (up to the mark) and replace the cap.
- Place the cuvette into the holder and close the lid.
- Press the **Zero** key. The display will show “-0.0-” when the meter is zeroed and ready for measurement.

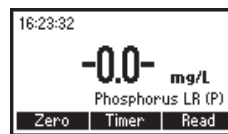
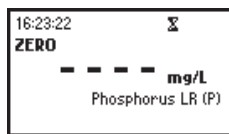
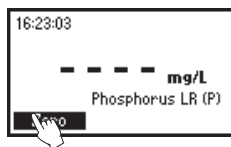
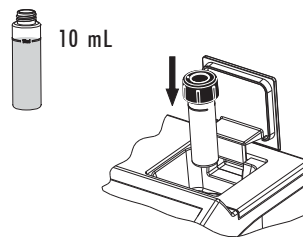

- Remove the cuvette.
- Add 10 drops of HI 93706A-0 Molybdate reagent.

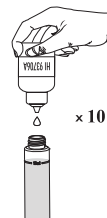

- Add the content of one packet of HI 93706B-0 Phosphorus Reagent B (Amino Acid) to the cuvette. Replace the cap and shake gently until completely dissolved.

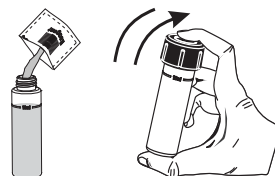

- Reinsert the cuvette into the instrument.

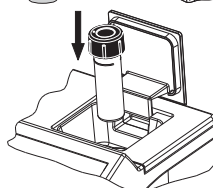

- Press **Timer** and the display will show the countdown prior to the measurement or, alternatively, wait for 5 minutes and press **Read**. When the timer ends the meter will perform the reading. The instrument displays the results in **mg/L of phosphorus (P)**.

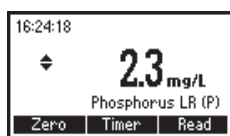
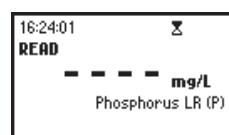
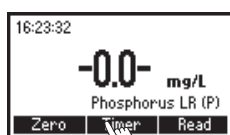

- Press **▲** or **▼** to access the second level functions.
- Press the **Chem Frm** key to convert the result in mg/L of phosphate (PO_4^{3-}) and phosphorus pentoxide (P_2O_5).

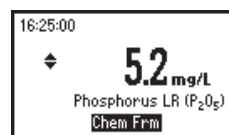
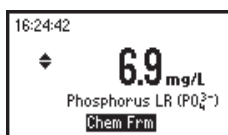
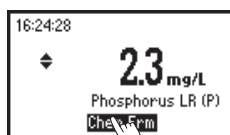

- Press **▲** or **▼** to return to the measurement screen.

INTERFERENCES

Interference may be caused by:

Sulfide

Chloride above 150000 mg/L

Calcium above 10000 mg/L as CaCO_3

Magnesium above 40000 mg/L as CaCO_3

Ferrous iron above 100 mg/L

POTASSIUM HIGH RANGE

SPECIFICATIONS

Range	20 to 200 mg/L
Resolution	5 mg/L
Accuracy	± 30 mg/L $\pm 7\%$ of reading at 25 °C
Typical EMC	± 5 mg/L
Deviation	
Light Source	Tungsten lamp with narrow band interference filter @ 610 nm
Method	Adaptation of the Turbidimetric Tetraphenylborate method. The reaction between Potassium and reagents causes turbidity in the sample.

REQUIRED REAGENTS

<u>Code</u>	<u>Description</u>	<u>Quantity</u>
HI 93750A-0	Potassium Reagent	6 drops
HI 93750B-0	Powder Reagent	1 packet

REAGENT SETS

HI 93750-01 Reagents for 100 tests

HI 93750-03 Reagents for 300 tests

For other accessories see page 50.

MEASUREMENT PROCEDURE

Note: for sample preparation follow the NUTRIENT SOLUTIONS (HR) procedure at page 21.

- Select the *Potassium HR* method using the procedure described in the *Method Selection* section (see page 12).
- Fill the cuvette with 10 mL of sample, up to the mark.
- Add six drops of HI 93750A-0, replace the cap and swirl the solution.
- Place the cuvette into the holder and close the lid.

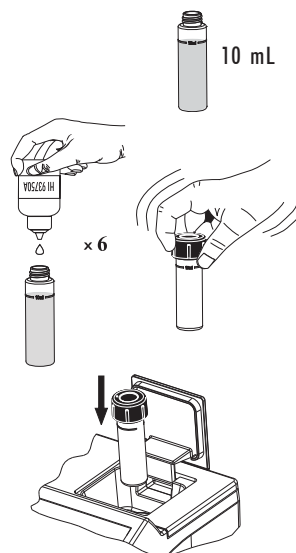

- Press the **Zero** key. The display will show “-0.0-” when the meter is zeroed and ready for measurement.

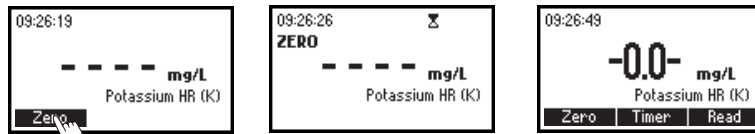

- Remove the cuvette and add the content of one packet of HI 93750B-0 reagent. Replace the cap and gently mix for one minute by slowly turning the cuvette upside down.

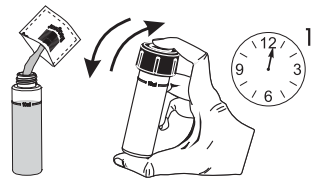

- Reinsert the cuvette into the instrument.

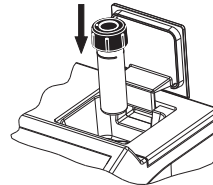

- Press **Timer** and the display will show the countdown prior to the measurement or, alternatively, wait for 2 minutes and press **Read**. When the timer ends the meter will perform the reading. The instrument displays the results in **mg/L (ppm) of potassium (K)**.

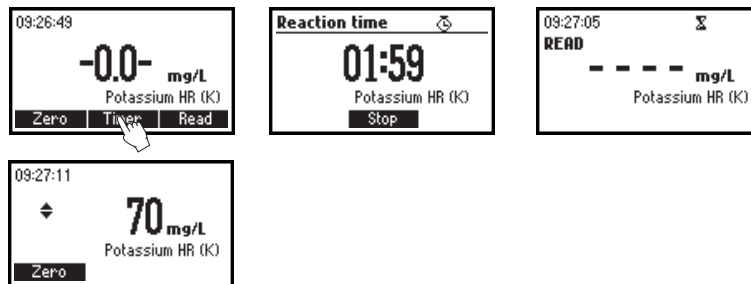

- Press **▲** or **▼** to access the second level functions.
- Press the **Chem Frm** key to convert the result in mg/L of potassium oxide (K₂O)

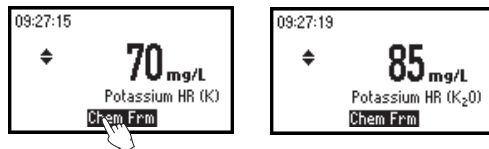

- Press **▲** or **▼** to return to the measurement screen.
- For **ULTRA HIGH RANGE** samples: follow the procedure described at page 43.

INTERFERENCES

Interferences may be caused by:

Ammonium above 10 ppm

Calcium above 10000 ppm as CaCO_3

Chloride above 12000 ppm

Magnesium above 8000 ppm as CaCO_3

Sodium above 8000 ppm

POTASSIUM ULTRA HIGH RANGE

For samples containing more than 200 ppm of Potassium: follow the sample preparation procedure described at page 21 for NUTRIENTS SOLUTION (HR). Then add to the graduated cylinder 20 mL of the prepared sample (for HR) and fill the cylinder with demineralized water from the Demineralizer Bottle up to the 100 mL mark.

Follow the MEASUREMENT PROCEDURE at page 41.

Read the result in mg/L of Potassium on the display and multiply the reading by 5 to obtain the actual concentration of Potassium.

POTASSIUM MEDIUM RANGE

SPECIFICATIONS

Range	10 to 100 mg/L
Resolution	2.5 mg/L
Accuracy	± 15 mg/L $\pm 7\%$ of reading at 25 °C
Typical EMC	± 2.5 mg/L
Deviation	
Light Source	Tungsten lamp with narrow band interference filter @ 610 nm
Method	Adaptation of the Turbidimetric Tetraphenylborate method. The reaction between Potassium and reagents causes turbidity in the sample.

REQUIRED REAGENTS

Code	Description	Quantity
HI 93750A-0	Potassium Reagent	6 drops
HI 93750B-0	Powder Reagent	1 packet

REAGENT SETS

HI 93750-01 Reagents for 100 tests

HI 93750-03 Reagents for 300 tests

For other accessories see page 50.

MEASUREMENT PROCEDURE

Note: for sample preparation follow the NUTRIENTS SOLUTION (MR) procedure at page 20.

- Select the *Potassium MR* method using the procedure described in the *Method Selection* section (see page 12).
- Fill the cuvette with 10 mL of sample, up to the mark.
- Add six drops of HI 93750A-0, replace the cap and swirl the solution.
- Place the cuvette into the holder and close the lid.

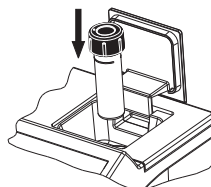
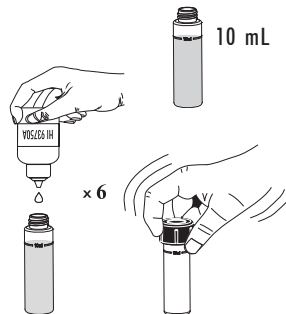

- Press the **Zero** key. The display will show “-0.0-” when the meter is zeroed and ready for measurement.

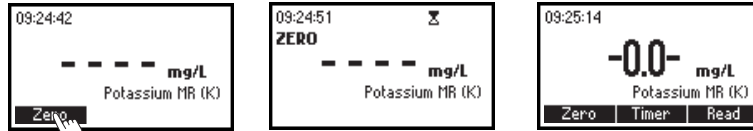

- Remove the cuvette and add the content of one packet of HI 93750B-0 reagent. Replace the cap and gently mix for one minute by slowly turning the cuvette upside down.

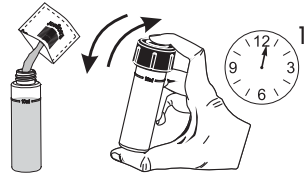

- Reinsert the cuvette into the instrument.
- Press **Timer** and the display will show the countdown prior to the measurement or, alternatively, wait for 2 minutes and press **Read**. When the timer ends the meter will perform the reading. The instrument displays the results in mg/L (ppm) of potassium (K).

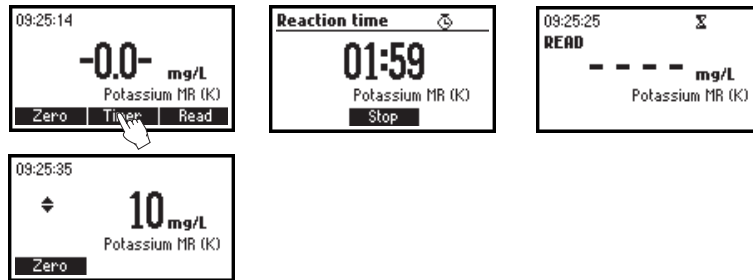
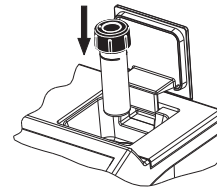

- Press **▲** or **▼** to access the second level functions.
- Press the **Chem Frm** key to convert the result in mg/L of potassium oxide (K_2O).



- Press **▲** or **▼** to return to the measurement screen.

INTERFERENCES

Interferences may be caused by:
 Ammonium above 10 ppm
 Calcium above 10000 ppm as $CaCO_3$
 Chloride above 12000 ppm
 Magnesium above 8000 ppm as $CaCO_3$
 Sodium above 8000 ppm

POTASSIUM LOW RANGE

SPECIFICATIONS

Range	0.0 to 20.0 mg/L
Resolution	0.5 mg/L
Accuracy	± 3.0 mg/L $\pm 7\%$ of reading at 25 °C
Typical EMC Deviation	± 0.5 mg/L
Light Source	Tungsten lamp with narrow band interference filter @ 610 nm
Method	Adaptation of the Turbidimetric Tetraphenylborate method. The reaction between Potassium and reagents causes turbidity in the sample.

REQUIRED REAGENTS

Code	Description	Quantity
HI 93750A-0	Potassium Reagent	6 drops
HI 93750B-0	Powder Reagent	1 packet

REAGENT SETS

HI 93750-01 Reagents for 100 tests

HI 93750-03 Reagents for 300 tests

For other accessories see page 50.

MEASUREMENT PROCEDURE

Note: for sample preparation follow the IRRIGATION WATER (LR) procedure at page 19.

- Select the *Potassium LR* method using the procedure described in the *Method Selection* section (see page 12).
- Fill the cuvette with 10 mL of sample, up to the mark.
- Add 6 drops of HI 93750A-0 Potassium Reagent, replace the cap and swirl the solution.
- Place the cuvette into the holder and close the lid.

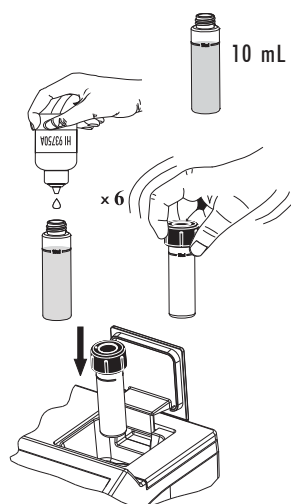

- Press the **Zero** key. The display will show “-0.0-” when the meter is zeroed and ready for measurement.

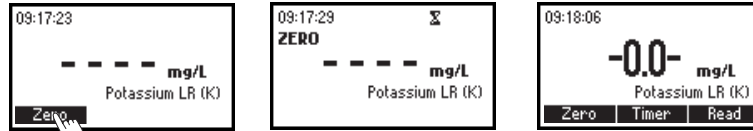

- Remove the cuvette and add the content of one packet of HI 93750B-0 reagent. Replace the cap and gently mix for one minute by slowly turning the cuvette upside down.

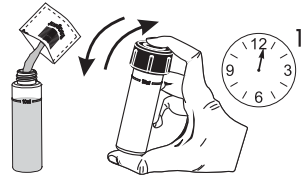

- Reinsert the cuvette into the instrument.
- Press **Timer** and the display will show the countdown prior to the measurement or, alternatively, wait for 2 minutes and press **Read**. When the timer ends the meter will perform the reading. The instrument displays the results in **mg/L (ppm) of potassium (K)**.

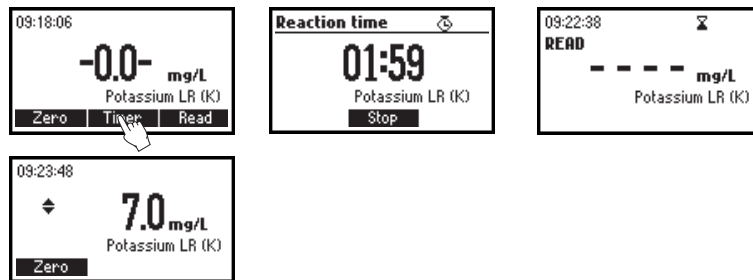
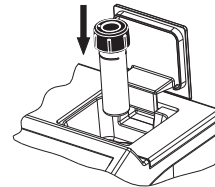

- Press **▲** or **▼** to access the second level functions.
- Press the **Chem Frm** key to convert the result in mg/L of potassium oxide (K_2O).

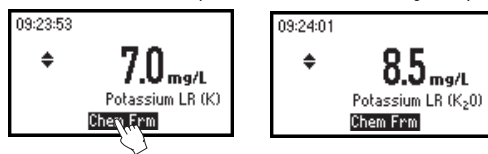

- Press **▲** or **▼** to return to the measurement screen.

INTERFERENCES

Interferences may be caused by:
 Ammonium above 10 ppm
 Calcium above 10000 ppm as $CaCO_3$
 Chloride above 12000 ppm
 Magnesium above 8000 ppm as $CaCO_3$
 Sodium above 8000 ppm

ERRORS AND WARNINGS

The instrument shows clear warning messages when erroneous conditions appear and when measured values are outside the expected range. These messages are described below.



No Light: The light source is not functioning properly.



Light Leak: There is an excess amount of ambient light reaching the detector.



Inverted cuvettes: The sample and the zero cuvettes are inverted.



Battery Low: The battery capacity is lower than 10%.



Light Low: The instrument cannot adjust the light level. Please check that the sample does not contain any debris.



Light High: There is too much light to perform a measurement. Please check the preparation of the zero cuvette.

DATA MANAGEMENT

The analyzed data can be managed using Hanna's product HI92000, Windows® Compatible Software.

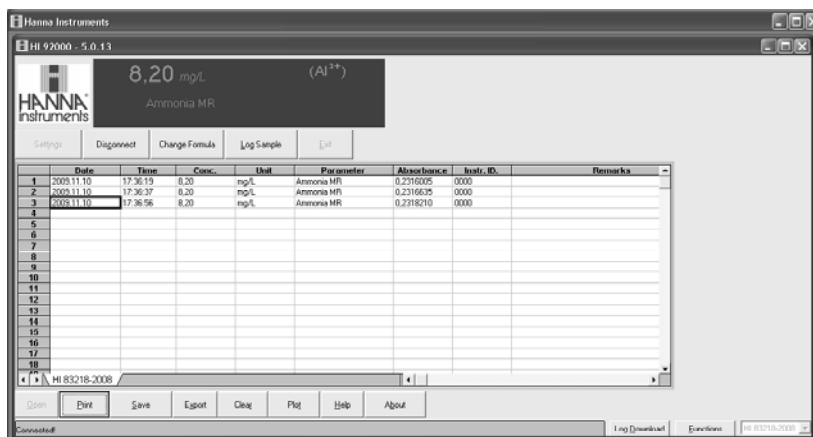

STANDARD METHODS

<u>Description</u>	<u>Range</u>	<u>Method</u>
Ammonia HR	0 to 100 mg/L	Nessler
Ammonia MR	0.0 to 50.0 mg/L	Nessler
Ammonia LR	0.0 to 10.0 mg/L	Nessler
Nitrate HR	0 to 300 mg/L	Cadmium Reduction
Nitrate MR	0 to 150 mg/L	Cadmium Reduction
Nitrate LR	0.0 to 30.0 mg/L	Cadmium Reduction
Phosphorus HR	0 to 100 mg/L	Amino Acid
Phosphorus MR	0.0 to 50.0 mg/L	Amino Acid
Phosphorus LR	0.0 to 10.0 mg/L	Amino Acid
Potassium HR	20 to 200 mg/L	Turbidimetric
Potassium MR	10 to 100 mg/L	Turbidimetric
Potassium LR	0.0 to 20.0 mg/L	Turbidimetric

Windows® is registered Trademark of "Microsoft Co."

ACCESSORIES

REAGENT SETS

HI 93706-01	100 phosphorus tests
HI 93706-03	300 phosphorus tests
HI 93715-01	100 ammonia tests
HI 93715-03	300 ammonia tests
HI 93728-01	100 nitrate tests
HI 93728-03	300 nitrate tests
HI 93750-01	100 potassium tests
HI 93750-03	300 potassium tests

OTHER ACCESSORIES

HI 731318	cloth for wiping cuvettes (4 pcs)
HI 731321	glass cuvettes (4 pcs)
HI 731325W	new cap for cuvette (4 pcs)
HI 740034	cap for 100 mL beaker (6 pcs)
HI 740036	100 mL plastic beaker (6 pcs)
HI 740157	plastic refilling pipette (20 pcs)
HI 740223	170 mL plastic beaker
HI 740224	170 mL plastic beakers (12 pcs)
HI 740225	60 mL graduated syringe
HI 740226	5 mL graduated syringe
HI 740227	filter assembly
HI 740228	filter discs (25 pcs)
HI 740229	100 mL graduated cylinder
HI 740230	230 mL demineralized water
HI 92000	Windows compatible software
HI 920013	PC connection cable
HI 93703-50	cuvette cleaning solution (230 mL)
HI 93703-54	dried resin (100 g)
HI 93703-55	activated carbon (50 pcs)

WARRANTY

All Hanna Instruments meters are warranted for two years against defects in workmanship and materials when used for its intended purpose and maintained according to the instructions.

This warranty is limited to repair or replacement free of charge.

Damages due to accident, misuse, tampering or lack of prescribed maintenance are not covered.

If service is required, contact your dealer. If under warranty, report the model number, date of purchase, serial number and the nature of the failure. If the repair is not covered by the warranty, you will be notified of the charges incurred.

If the instrument is to be returned to Hanna Instruments, first obtain a Returned Goods Authorization Number from the Customer Service Department and then send it with shipment costs prepaid. When shipping any instrument, make sure it is properly packaged for complete protection.

To validate your warranty, fill out and return the enclosed warranty card within 14 days from the date of purchase.

Recommendations for Users

Before using these products, make sure that they are entirely suitable for your specific application and for the environment in which they are used.

Operation of these instruments may cause unacceptable interferences to other electronic equipments, this requiring the operator to take all necessary steps to correct interferences.

Any variation introduced by the user to the supplied equipment may degrade the instruments' EMC performance.

To avoid damages or burns, do not put the instrument in microwave ovens. For yours and the instrument safety do not use or store the instrument in hazardous environments.

Hanna Instruments reserves the right to modify the design, construction and appearance of its products without advance notice.

HANNA LITERATURE

Hanna publishes a wide range of catalogs and handbooks for an equally wide range of applications. The reference literature currently covers areas such as:

- **Water Treatment**
- **Process**
- **Swimming Pools**
- **Agriculture**
- **Food**
- **Laboratory**

and many others. New reference material is constantly being added to the library.

For these and other catalogs, handbooks and leaflets contact your dealer or the Hanna Customer Service Center nearest to you. To find the Hanna Office in your vicinity, check our home page at www.hannainst.com.



Hanna Instruments Inc.
Highland Industrial Park
584 Park East Drive
Woonsocket, RI 02895 USA

Technical Support for Customers
Tel. (800) 426 6287
Fax (401) 765 7575
E-mail tech@hannainst.com
www.hannainst.com

Local Sales and Customer Service Office

