

proceq

PROFOSCOPE OPERATING INSTRUCTIONS



Contents

- 1. Safety and Liability 5**
 - 1.1 Safety and Usage Precautions 5
 - 1.2 Liability..... 5
 - 1.3 Safety Instructions..... 5
 - 1.4 Designated Use 5
 - 1.5 Labeling used in the Manual..... 5

- 2. Overview of the Profoscope 6**

- 3. Tutorial..... 7**
 - 3.1 The Measurement Principle..... 7
 - 3.2 Calibrated Measuring with Profoscope 7
 - 3.3 The Measuring Range..... 8
 - 3.4 Factors Affecting the Measurement..... 8

- 4. Getting Started 11**

- 5. Performing a Real Test..... 12**
 - 5.1 Preparations 12
 - 5.2 Locate a Rebar 13
 - 5.3 Measure Cover Depth..... 18
 - 5.4 Measure Rebar Diameter..... 22

- 6. Settings..... 24**
 - 6.1 Navigating through the Settings Menu 24
 - 6.2 Regional Setting..... 25
 - 6.3 Rebar Diameter..... 25
 - 6.4 Measuring Range Selection 26
 - 6.5 Audio Setting..... 26
 - 6.6 Minimum Cover..... 26
 - 6.7 Neighboring Bar Compensation 27
 - 6.8 Memory Function (for Profoscope+ only) 27

- 7. Technical Specifications 29**

- 8. Standards and Guidelines 30**
 - 8.1 Standards 30
 - 8.2 Guidelines 30

- 9. Part Numbers and Accessories 30**

- 10. Maintenance and Support..... 31**
 - 10.1 Protective Cover and Batteries 31
 - 10.2 Support Concept 31
 - 10.3 Standard Warranty and Extended Warranty 31

- 11. Quick Reference Guide for ProfoLink (for Profoscope+ only) 31**
 - 11.1 Installation..... 31
 - 11.2 Data Management and File structure: 32

1. Safety and Liability

1.1 Safety and Usage Precautions

This manual contains important information on the safety, use and maintenance of the Profoscope. Read through the manual carefully before the first use of the instrument. Keep the manual in a safe place for future reference.

1.2 Liability

Our “General Terms and Conditions of Sale and Delivery” apply in all cases. Warranty and liability claims arising from personal injury and damage to property cannot be upheld if they are due to one or more of the following causes:

- Failure to use the instrument in accordance with its designated use as described in this manual.
- Incorrect performance check for operation and maintenance of the instrument and its components.
- Failure to adhere to the sections of the manual dealing with the performance check, operation maintenance of the instrument and its components.
- Unauthorized structural modifications to the instrument and its components.
- Serious damage resulting from the effects of foreign bodies, accidents, vandalism and force majeure.

All information contained in this documentation is presented in good faith and believed to be correct. Proceq SA makes no warranties and excludes all liability as to the completeness and/or accuracy of the information.

1.3 Safety Instructions

The instrument is not allowed to be operated by children or anyone under the influence of alcohol, drugs or pharmaceutical preparations. Anyone who is not familiar with this manual must be supervised when using the instrument.

1.4 Designated Use

- The instrument is only to be used for its designated purpose as described in these operating instructions.
- Replace faulty components only with original replacement parts from Proceq.
- Accessories should only be installed or connected to the instrument if they are expressly authorized by Proceq. If other accessories are installed or connected to the instrument then Proceq will accept no liability and the product guarantee is forfeit.

1.5 Labeling used in the Manual



NOTE! This symbol indicates important information.

2. Overview of the Profoscope

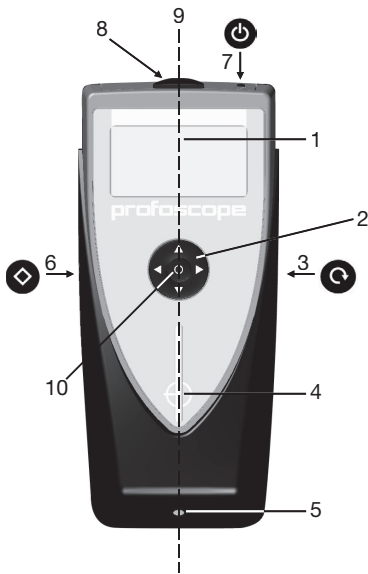

- 1 Display
- 2 Navigation
- 3 Reset Key
- 4 Measurement Center (MC)
- 5 LED Indicator
- 6 Function Key
- 7 On/Off Button
- 8 Battery Compartment
- 9 Center Line (CL)
- 10 Select Button

Fig 1: Profoscope set up

The Profoscope Display

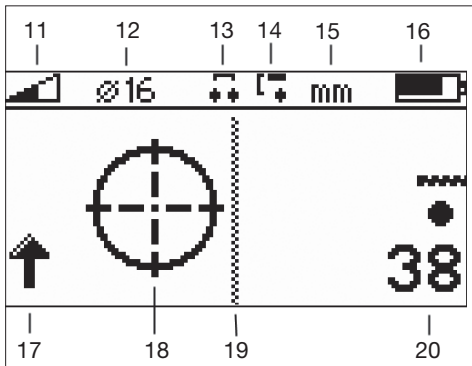

- 11 Measuring Range (Standard, Auto)
- 12 Reference Rebar Diameter
- 13 Neighboring Rebar Correction Active
- 14 Minimum Cover Alert¹ Active
- 15 Measuring Unit
- 16 Battery Status
- 17 Signal Strength (Increasing / Decreasing)²
- 18 Rifle Scope
- 19 Center Line
- 20 Measured Cover Depth

Fig 2: Profoscope display

¹ The minimum cover alert is automatically deactivated, when the memory function is set. One of the three icons appears instead, see 6.8.

² The signal strength arrow is replaced by the measured bar diameter: e. g. when the Function Key (6) for bar diameter is pressed.

3. Tutorial

3.1 The Measurement Principle

The Profoscope uses electromagnetic pulse induction technology to detect rebars. Coils in the probe are periodically charged by current pulses and thus generate a magnetic field. On the surface of any electrically conductive material which is in the magnetic field eddy currents are produced. They induce a magnetic field in the opposite direction. The resulting change in voltage can be utilized for the measurement.

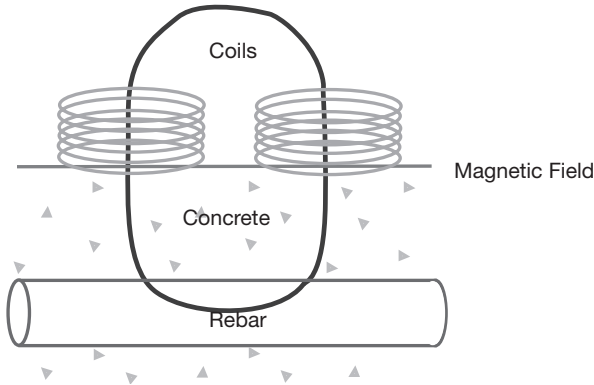

Fig 3: Measurement principle

The Profoscope uses different coil arrangements to generate several magnetic fields. Advanced signal processing allows

1. Localization of a rebar
2. Localization of the mid-point between rebars.
3. Determination of the cover
4. Estimation of the bar diameter

This method is unaffected by all non conductive materials such as concrete*, wood, plastics, bricks etc. However any kind of conductive materials within the magnetic field (approx. 400 mm / 16" sphere) will have an influence on the measurement.

* Some concrete types and other structural materials may have metallic content.



NOTE! Remove all metallic objects such as rings and watches before you start measuring.

3.2 Calibrated Measuring with Profoscope

The Profoscope is calibrated to measure on a normal rebar arrangement; which is an arrangement of non-stainless steel rebars fastened with binding wires only. E. g. when measuring on welded mesh wires the cover and diameter readings must be corrected (see 5.3.3 and 5.4.5). The following information on accuracy, measuring ranges and resolutions refer to measurements on such normal rebar arrangements.

3.3 The Measuring Range

The pulse induction principle used by Profoscope has defined operating ranges and accuracies. The measuring range is dependent on the bar size. The expected accuracy of the cover measurement is indicated in the graphic below. (Complies with BS1881 part 204, for a single rebar with sufficient spacing and known diameter).

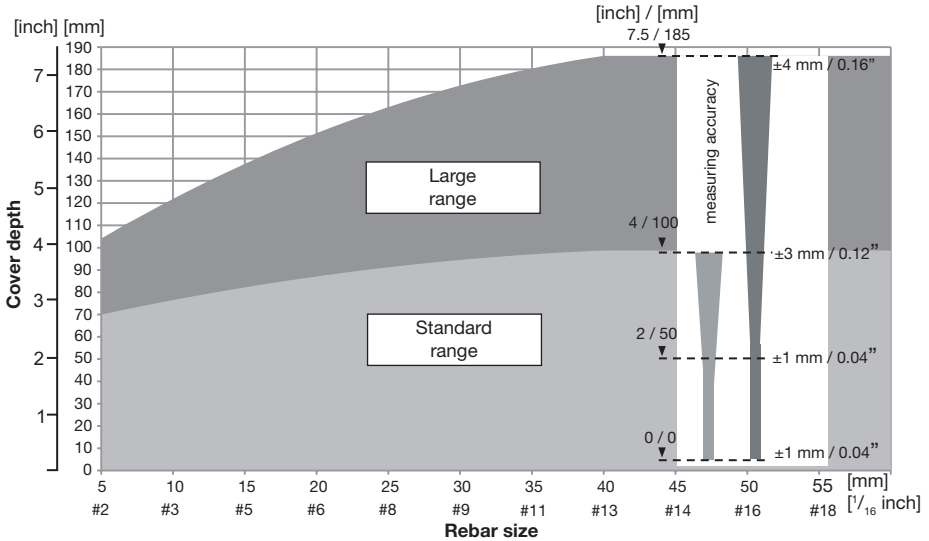
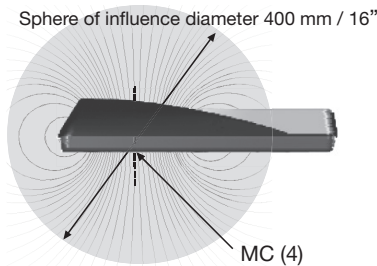

Fig 4: Measuring ranges

3.4 Factors Affecting the Measurement

3.4.1 Errors due to Neighboring Bars

All rebars within the sphere of influence affect the reading.



Any ferromagnetic material within the sphere may have an influence on the signal value (e.g. during a reset)

Fig 5: Influence area

i NOTE! This effect can be reduced by the neighboring bar correction implemented in the Profoscope.

3.4.2 Resolution

There is a limit to the minimum spacing of bars depending on the cover depth and rebar diameter. It is impossible to distinguish between individual bars above these limits.

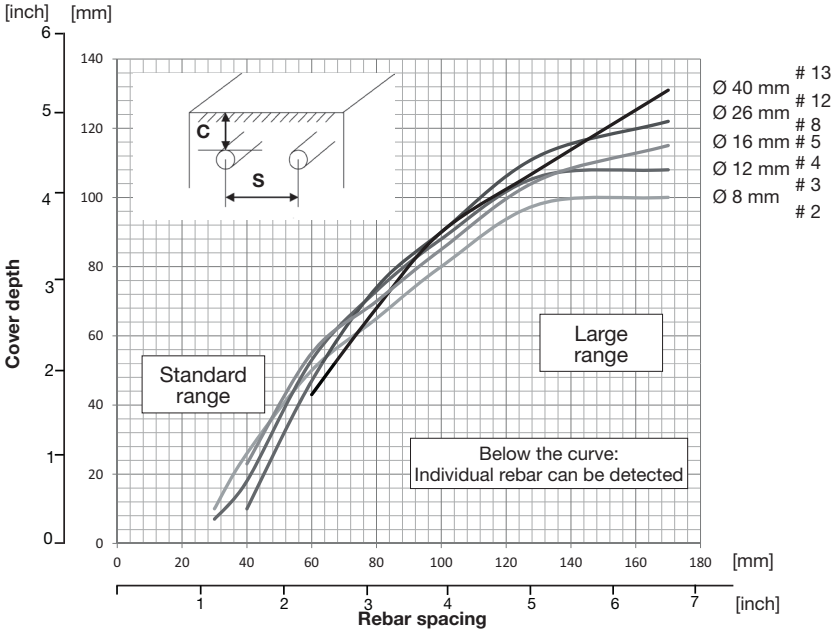

Fig 6: Resolution

3.4.3 Effect of Setting Incorrect Bar Diameter

The accuracy of the cover measurement is also dependent on setting the correct bar diameter. The following chart gives an estimation of the error of the cover reading for different rebar sizes if a default size of 16 mm / #5 is set.

i NOTE! In case the diameter is not known and cannot be measured the rebars should be exposed in one area to set the correct diameter in the Profoscope. With the correct diameter set the cover over a single rebar can be measured with the accuracy shown in chapter 3.3.

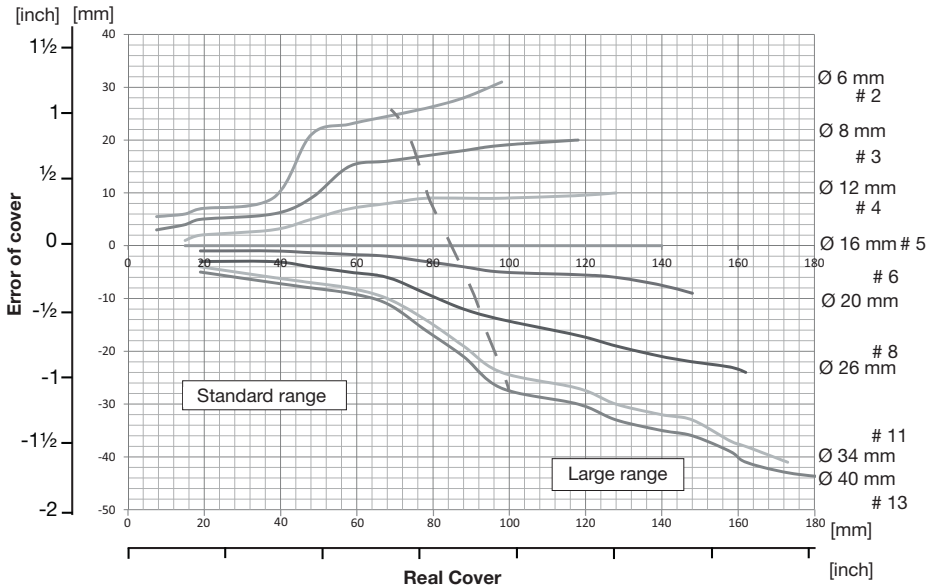

Fig 7: Error values for covers measured with default diameter of 16 mm / # 5 set

3.4.4 Factors Affecting Diameter Determination

Two factors affect the determination of the rebar diameter. One is the cover depth. Diameter can be determined for rebars with cover not exceeding 80% of the Standard range. 64 mm / 2.5".

The second is the spacing between neighboring bars. For accurate determination of the diameter, the spacing between the rebars must be greater than the limits shown in the drawing below with reference to the MC (4).

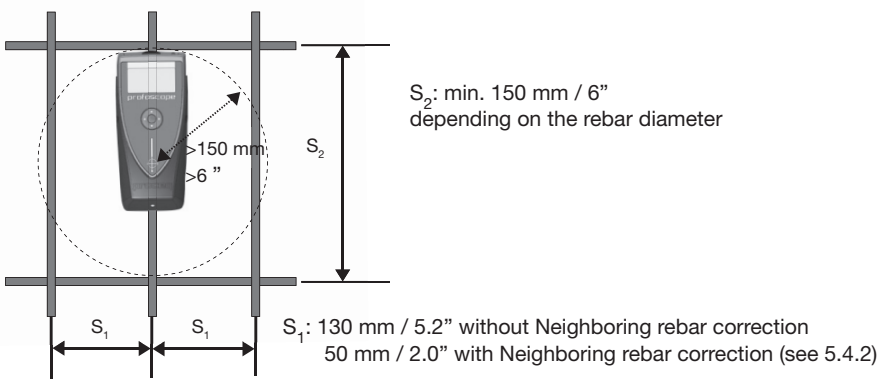

Fig 8: Minimum rebar spacing for correct readings

3.4.5 Orientation



The strongest signal results when the Center Line (9) of the probe is parallel to a bar. The Center Line (9) in the Profoscope is the long axis of the instrument. This property is used to help determine the orientation of the rebars (see 5.2.3).

4. Getting Started

A start-up test kit (two 16 mm / #5 diameter rebars) is provided with the packaging to help you familiarize yourself with the instrument.



NOTE: Complete the tutorial or see a demo by a qualified Proceq representative.

1. Verify that there are no metal items on hands, fingers, or in the vicinity of the test area, (e. g. steel frame of the table, metal trolleys etc.)
2. Power on: Press the On/Off Button (7)  on the top panel.
3. Reset the instrument with the Reset Key (3) 
4. Check the location of the Measurement Center (MC) which indicates the center of the probe.

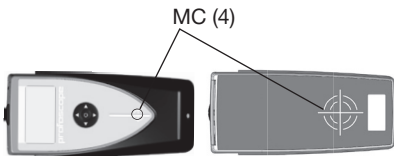

Fig 9: Measurement Center (MC)

5. Check the operation with the start-up test kit and confirm:
 - The location and orientation of the rebars
 - The position between two rebars
 - Cover depths approximately 15 mm / 0.59 and 60 mm / 2.36"
 - Diameter 16 mm / #5, see 3.4.1

Congratulations! Your new Profoscope is fully operational and you can now continue with your measurements.

Performing a Reset



The pulse induction measuring principle is prone to drift with temperature and other external influences. Performing a reset corrects for any drift and ensures accurate measurements. We recommend a reset every 5 minutes or so.

On power on, the Profoscope reminds the user to perform a reset.

Fig 10: Reset

Hold the Profoscope in free space (no metal within a 200 mm / 8" sphere) and press the Reset Key (3) . A circular arrow rotates on the display for approximately 2.5 seconds while the reset is carried out.

5. Performing a Real Test

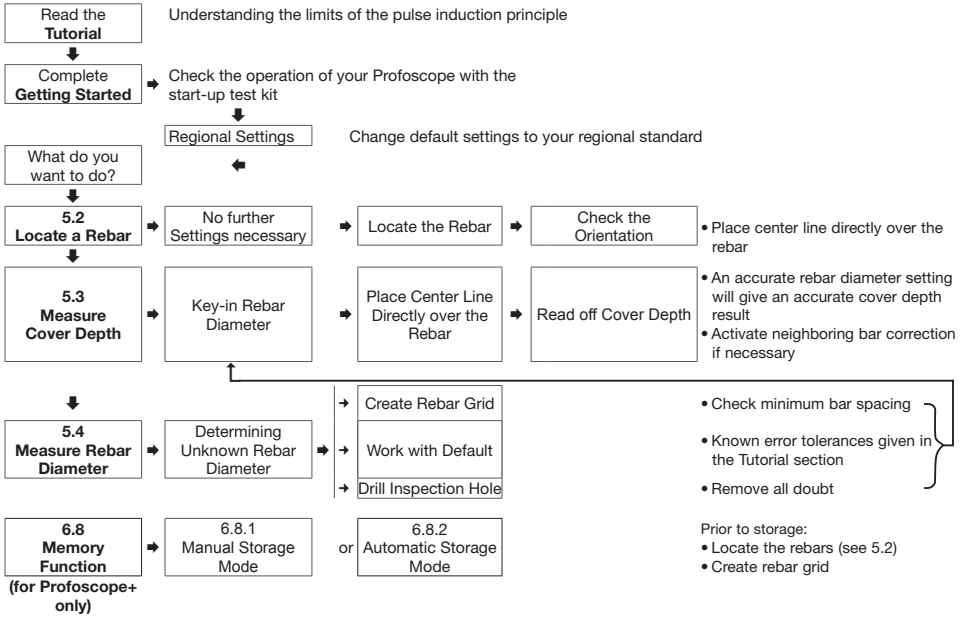

5.1 Preparations

5.1.1 Measuring Screen Short Cuts

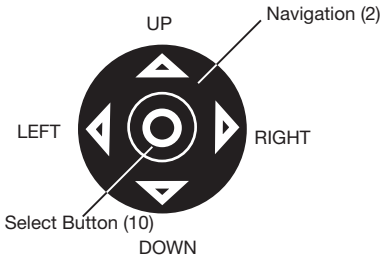







Pressing the up arrow will switch the back-light on/off.

Pressing the right arrow toggles between measuring ranges.

Fig 11: Short cuts

5.1.2 Settings in the Main Menu

Prior to the measurements, check if the correct settings are selected (see 4.).

- **Regional Setting**  Choose between Metric, ASTM inch, ASTM mm or Japanese Bar Diameter
Keep the default diameter of 16 mm / #5
- **Bar Diameter**  Keep the default diameter of 16 mm / #5
- **Measuring Range**  Choose the “Auto” mode (see also short cuts in chapter 5.1.1)
- **Audio Setting**  Set it according to your preference
- **Minimum Cover Alert**  Must be turned off by setting (-)
- **Neighboring Bar Correction**  Must be turned off by setting (-)
- **Memory function**  (for Profoscope+ only)
Must be turned off by setting (-)

5.2 Locate a Rebar

Switch on the Profoscope and perform a reset as explained in “Getting Started”. The Profoscope can immediately be used to locate a rebar.



NOTE! The Profoscope is able to locate a rebar and also the mid-point between two rebars. It is important to be able to distinguish between the two situations.

5.2.1 Finding a Rebar

Place the Profoscope on the test surface and move it slowly in a chosen direction. The Profoscope reacts differently depending on its orientation relative to the rebars. There are three scenarios.

Scenario A: Sweeping Perpendicular to the Rebars

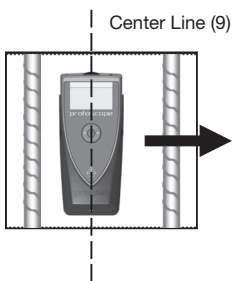

The Center Line (9) is in parallel to the rebars
This is the correct scenario to detect the rebars.
Try it out on the start up test kit.

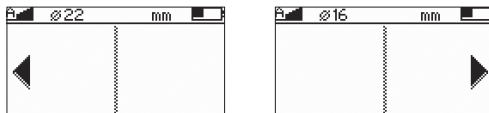

Arrows   on screen indicate of the rebar.

Fig 12: Sweeping perpendicular and display of rebar proximity

Continue sweeping in the chosen direction.

As you get closer, the Rifle Scope indicates either:

- The presence of a rebar beneath the instrument or,
- The mid-point between two rebars beneath the instrument.

It is very simple to differentiate between the two.

Approaching a Rebar

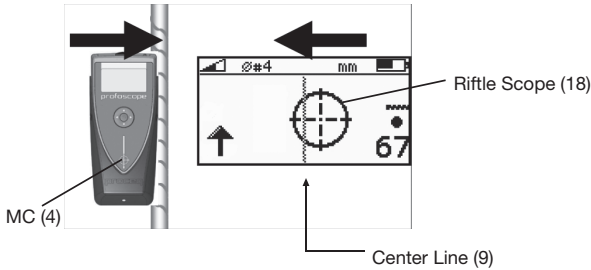

Fig 13: Approaching a rebar

Rifle Scope moves in opposite direction to the Profoscope.

The signal strength is increasing ↑ as the Rifle Scope moves towards the Center Line (9).

Continue sweeping until the Rifle Scope is exactly at the Center Line (9). The LED Indicator will light. (If the acoustic signal is activated it will sound as long as the LED is lit). The rebar is directly beneath the MC (4).

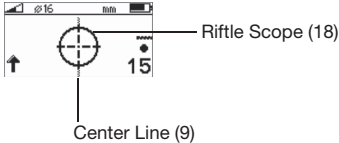

Fig 14: Rebar centered

Approaching a Midpoint

The Rifle Scope moves in the same direction as the Profoscope.

The signal strength is decreasing ↓ as the Rifle Scope moves towards the Center Line (9).

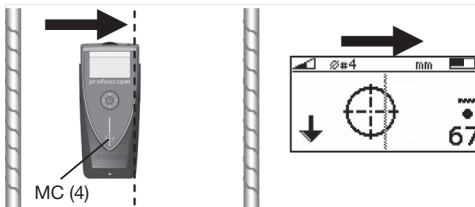

Fig 15: Approaching a mid point

Continue sweeping until the Rifle Scope is exactly at the Center Line (9). The midpoint is directly beneath the MC (4). The LED Indicator will not light.

Distinguishing between a Rebar and a mid point

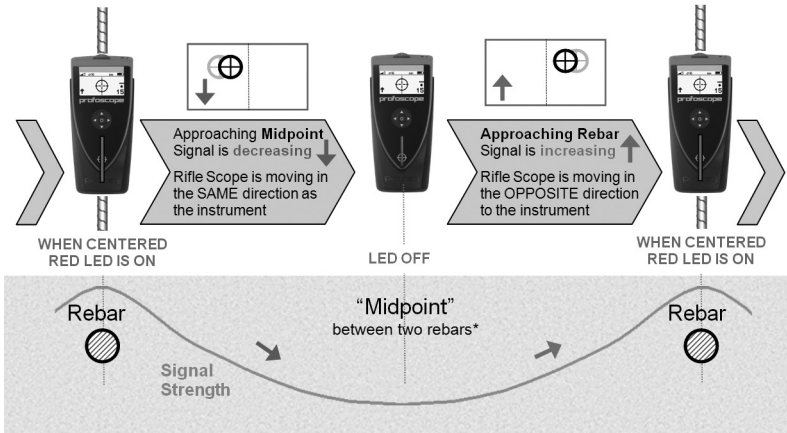

Fig 16: Distinguishing between a Rebar and a mid point

Scenario B: Sweeping Parallel to the Rebars

The Center Line (9) is perpendicular to the rebars.

Try it out on the start up test kit.

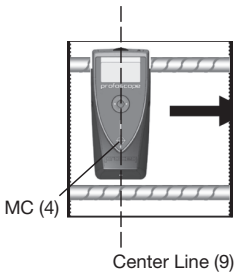

Fig 17: Sweeping parallel

If there are rebars within the range, the Rifle Scope will remain close to the Center Line (9) of the screen and moves very little.

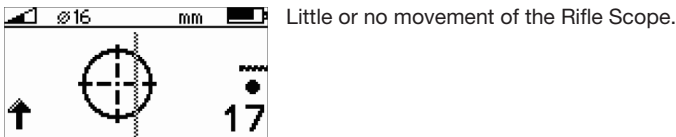
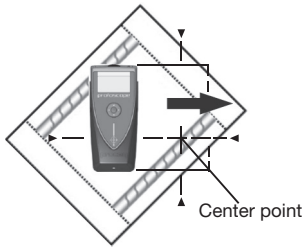

Fig 18: Rifle close to the Center Line (9)

In this case turn the Profoscope by 90° and continue sweeping as described under Scenario A) above.

Scenario C: Sweeping at an Angle to the Rebars

Markings for MC (4)



Try it out on the start up test kit.

Fig 19: Sweeping at an angle

The response on the screen will be similar to the case when you are sweeping perpendicular (Scenario A), but the movement of the Rifle Scope will be slower.

Move the Profoscope until the LED lights. The MC (4) is precisely above the rebar. Mark the position of the MC (4) on all four sides of the Profoscope, thus the center point for checking the orientation (see 5.2.2) is defined on the test surface.

5.2.2 Check the Rebar Direction

Once you have defined the center point, you need to check the direction of the rebar by rotating around the center point.

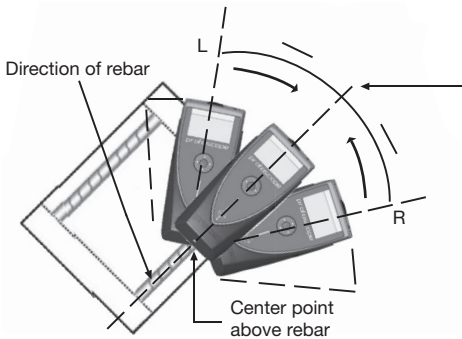

Try it out on the start up test kit.

LED-Light up when Center Line (9) over the rebar

Fig 20: Checking the rebar direction

Position the Profoscope with the lower edge (LED output) of the Center Line (9) at the center point of the rebar. Rotate the Profoscope around this center point either from left (L) or right (R). It will light up once the Center Line (9) is precisely over and parallel to the rebar. Mark the position of the Center Line (9) at the display side of the Profoscope. A line drawn through this point and the marked center point will give the orientation of the rebar.



NOTE! The signal strength arrow \downarrow \uparrow can be used as an aid here. The signal strength will increase as you rotate towards the correct orientation and decrease as rotate away.

5.2.3 Verification of the Cover along one Rebar

Verify by moving the Profoscope with the Center Line (9) parallel to the rebar direction and with the MC (4) directly above the rebar. Observe that the cover depth reading displays a constant value. You may also start directly with the mapping of the rebar grid, see 5.2.4.

5.2.4 Map out the Rebar Grid

“Reset Key (3)”  the Profoscope and proceed with Scenario A to locate further rebars. Sweep in one direction first and then at 90° to build up the grid.

Please consider the following advice when measuring with the Profoscope:

- Whenever possible begin by locating the first rebar layer. (e. g. in a column the horizontal stirrups are the first layer), i. e. hold the Profoscope with the Center Line (9) horizontal and move the Profoscope in the vertical direction. Mark the locations of the first layer on the surface.
- When locating the second layer (e. g. in a column the vertical rebars are the second layer) hold the Profoscope with the Center Line (9) perpendicular to the rebars of the first layer (e. g. in a column hold it vertical). Now move the instrument with the MC (4) along the midpoint line of two first layer rebars parallel to direction of the first layer (e. g. in a column move it horizontally) to detect the rebars of the second layer.

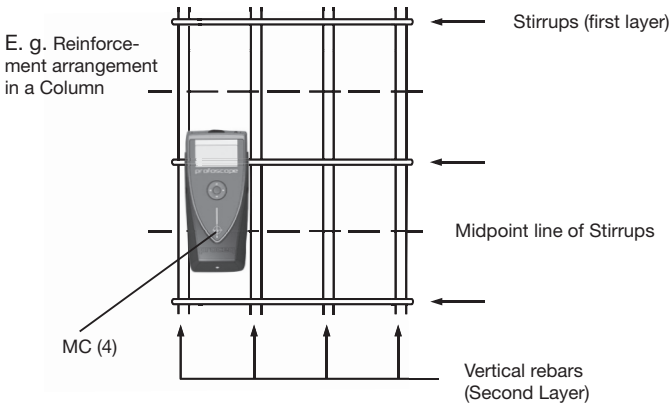

Fig 21: Creation of a rebar map

You will soon see the rebar configuration to help you begin drilling or to conduct further measurements of cover depth (see 5.3) and rebar diameter (see 5.4), with storage of values (see 6.1, only with Profoscope+ possible) and so forth.

5.3 Measure Cover Depth

Once the rebar grid has been located the cover can be measured.



NOTE! In all cases mentioned under 5.3.2 and 5.3.3 (especially when the measured cover is close to a minimum required one), it is advisable to expose at least one first layer rebar of each rebar arrangement to determine the real cover. The measured covers can then be compared and if necessary corrected with the real cover.

5.3.1 Cover Measurement on areas with sufficient Spacing of the Rebars

A sufficient spacing is equal to or larger than the minimum spacing defined in 3.4.4.

Set the Rebar Diameter

An accurate knowledge of the rebar diameter will also give best cover depth results.

The default Reference Rebar Diameter set in the instrument is 16 mm or #5. This can be seen in the status row at the top of the display screen.

If you already know the actual rebar diameter, select the icon in the menu to set this as the reference.



NOTE! If you DO NOT know the rebar diameter, then proceed to 5.4. to measure the diameter first. But this is only possible to a maximum cover of 60 mm to 65 mm / 2.5" to 2.6".

Now you can set the measured diameter.

Read the Cover Depth

Place the centre line of the Profoscope directly over the rebar and read off the cover depth.

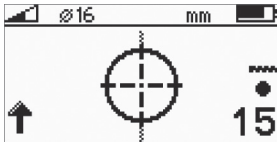

e. g.

Cover depth = 15 mm

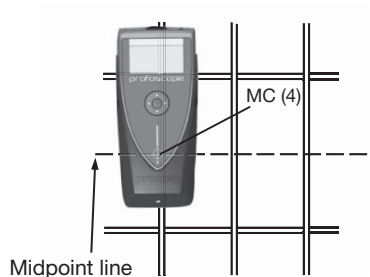

Fig 22: Display of cover depth

Fig 23: Cover depth measurements



NOTE! Ensure that the Centre Line (9) is directly over and in line with the rebar and that the MC (4) is ideally at the midpoint between two rebars of the second layer.

5.3.2 Cover Measurement on Areas with insufficient Spacing of the Rebars

An insufficient spacing is smaller than the minimum spacing defined in 3.4.4.

Special case of Rebars without spacing

In overlapping areas the rebars are normally tied together: e. g. this is the case in a cut and cover tunnel section on the lower part of the side walls, where rebars from the bottom slab are tied together with the vertical rebars of the wall.

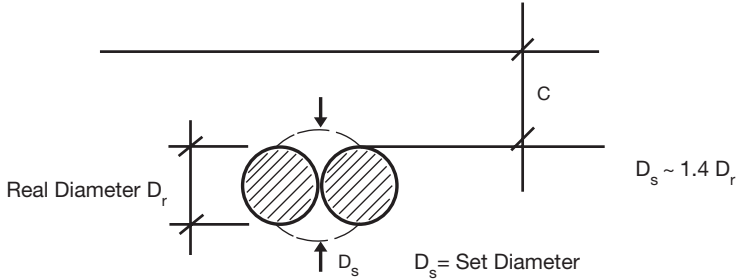

Fig 24: Measured diameter D_s at overlapping areas

In such areas you will measure a larger diameter and a smaller cover than it is actually the case. However, the accuracy of the cover measurement can drastically be increased by setting the measured diameter in the Profoscope prior to the measurements. In case the diameter can not be measured the rebars should be exposed in one area. The diameter to be set is in general 1.4 times the real diameter of a single bar.

Covers	12	18	26	34	40	Real Diameter D_r
	16	25	40	40	40	Set Diameter D_s
19	1	0	0	0	1	Accuracy in mm when measured with the diameter D_s set
38	2	0	0	2	3	
58	3	0	1	4	4	
88	4	0	0	8	10	
98	4	0	0	9	12	
108		0	0	10	14	
128		0	-1	12	17	
158			-3	12	21	
163				12	22	
168				13	23	
178					24	

Tab. 1 Accuracy of cover measurements at overlapping rebars

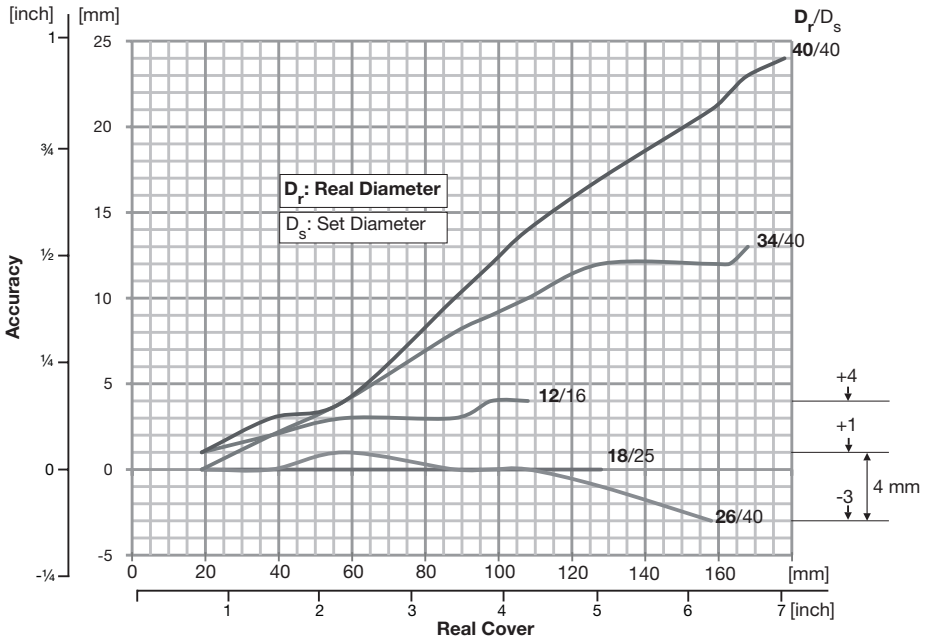

Fig 25: Accuracy of cover measurements and overlapping rebars

Table 1 and Figure 25: Accuracy for cover measurements when setting the measured diameter

- For smaller rebars with a diameter up to 16 mm / # 5 the accuracy of cover measurement is within 1 mm to 4 mm / 0.04" to 0.16"
- For rebars with a diameter from about 18 mm to 30 mm / # 6 to # 9 the accuracy of cover measurement is within 0 to 3 mm / 0.00" to 0.12"



NOTE! Without setting the measured diameter the error can be up to 44 mm / 1.73"

- For larger rebars with a diameter > 30 mm / > # 9 the accuracy of cover measurement is within 1% to 15% of the actual cover.

The accuracy is decreasing with larger cover.

Special case of measuring cover at stirrups

You will find typical arrangement of rebars with stirrups in concrete beams, columns, piles and girders. For some common arrangements you may refer to the Excel-Macro "Cover Measurement at Stirrups" on our website www.proceq.com under Profoscope.



NOTE! In all other cases the first layer rebar must be exposed on some spots to determine the real cover and compare it with the Profoscope readings.

5.3.3 Measurements over Welded Reinforcement Meshes

The instrument cannot detect whether the rebars are welded to one another or connected with binding wires. The two reinforcement types with the same dimensions however create different signals. The setting of the bar diameter must be slightly higher than the actual diameter of the mesh rebar. The input depends on the bar diameter and on the mesh spacings. This input value should be determined by means of a test on an open system with specific rebar mesh wire arrangements. Measure on each arrangement with different covers to find out the diameter setting at which the correct cover is indicated.

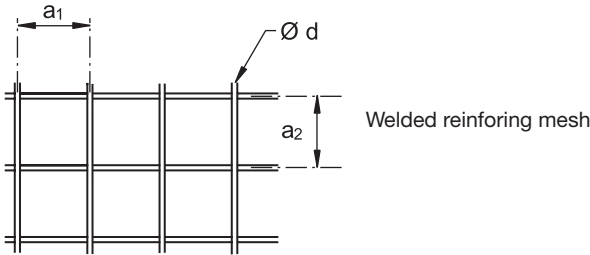

a_1 [mm]	a_2 [mm]	current d [mm]	d to be set [mm]
100	100	5	8
150	150	6	7

Fig 26: Examples for diameter settings at welded mesh

Select the “Standard” measuring range. The “Large” measuring range cannot be used with welded reinforcing meshes. Locate and measure the cover as explained in the previous chapters.

5.3.4 Minimum Cover Alert



This is particularly useful for detecting insufficient concrete cover depth when conducting large scale checks on structures after removing the formwork or large scale building inspections and so forth.

Enter the settings menu, select the icon and set the required cover depth limit. Verify that minimum cover alert symbol  is active in the status line at the top of the display.

Move the Profoscope over the test surface. Whenever the cover depth is less than the programmed minimum the LED Indicator will light and if it is enabled, an acoustic alarm will be given.



NOTE! In this mode the LED will not light to indicate that a rebar has been located.

5.4 Measure Rebar Diameter

In case the real rebar diameter is not known, the Profoscope can accurately determine the diameter of a rebar under certain conditions.



NOTE! The determination of the rebar diameter with Profoscope is limited to a maximum cover of 64 mm / 2.5".

The tutorial chapter on the pulse induction principle describes the limitations of the technology and clearly outlines the conditions whereby accurate readings of rebar diameter CANNOT be made if there is too much interference from neighboring rebars or other metallic objects within the sphere of influence.

We present four working methods which are recommended to obtain the best results.



NOTE! In all cases mentioned under 5.4.2 and 5.4.3, it is advisable to expose at least one first layer rebar of each rebar arrangement to measure the real diameter. The obtained diameter values can then be compared and if necessary corrected with the measured real diameter.

5.4.1 Diameter Measurement on Areas with sufficient Spacing of the Rebars

A sufficient spacing is equal or larger as the minimum spacing defined in 3.4.4.

Method 1

Map out a rebar grid on a test surface and then select one rebar from the grid that has sufficient spacing from other rebars.

- Step 1 Create a rebar grid as described in 5.2.4.
- Step 2 Select one rebar that has the largest spacing from neighboring rebars.
- Step 3 Use a ruler and confirm that the spacing is at least as indicated in 3.4.4. If not, redo Steps 1 and 2 until a rebar is located with the required spacing to a neighboring rebar.
- Step 4 Place the MC (4) of the Profoscope over the rebar at the midpoint line of the rebars running crosswise to the rebar under test and click the Function Key (6)  on the left side.

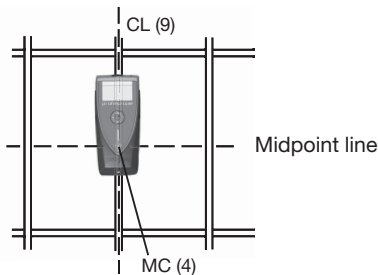

Fig 27: Diameter measurement

The measured rebar diameter appears for a few seconds instead of the signal strength arrow on the bottom left corner of the display.

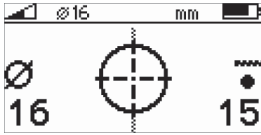

Fig 28: Display of measured diameter

Note down the rebar diameter. With the Profoscope+ you may also store the measured diameter (see 6.8.1).

5.4.2 Diameter Measurement on Areas with insufficient Spacing of the Rebars (Neighboring Rebar Correction)

Method 2





As described in the tutorial neighboring rebars that are within the sphere of influence will also be detected by the Profoscope and will affect cover depth and diameter estimation results. A insufficient spacing is smaller as the minimum spacing defined in 3.4.4.

The effects of neighboring rebars can be mitigated by keying-in a correction value.



NOTE! This works only for rebars of the same layer running in parallel to the rebar under test.

- Step 1 Create a rebar as described in 5.2.4.
- Step 2 Select one rebar that has the largest spacing from neighboring rebars.
- Step 3 Use a ruler to measure the spacing. In case the spacing from the rebar under test to a neighboring rebar is equal or less than 130 mm / 5.2" go to the main menu, select the icon  and input the measured spacing. Verify that neighboring rebar correction symbol  is active in the status line at the top of the display.
- Step 4 Place the MC (4) of the Profoscope over the rebar at the midpoint line of the rebars running crosswise to the rebar under test and click the Function Key (6)  on the left side.

The measured rebar diameter appears for a few seconds instead of the signal strength arrow on the bottom left corner of the display.

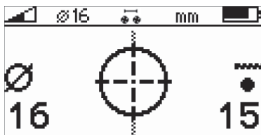



Fig 29: Display of measured diameter with neighboring rebar correction set

Note down the rebar diameter. With the Profoscope+ you may also store the measured diameter (see 6.8.1).

Try it out on the start-up test kit.

5.4.3 Work with a Default Value

Method 3

The purpose of this approach is to work with a default value with known error tolerances. From the menu item “Bar diameter”  select the default value 16 mm or #5 for the diameter.

Use the chart in section 3.4.3 of the tutorial to understand the errors that can be expected in the cover readings when the actual rebar diameters differ from the reference value. You may correct the measured cover with the error value.

5.4.4 Drill an Inspection Hole

Method 4

The purpose of this approach is to accurately determine the rebar diameter through destructive means.

If neither of the methods 1, 2 and 3 are feasible for whatever reason and you are still in doubt (this could be the case when rebars are bunched too close together or are too small in diameter), then drill an inspection hole wide enough to allow the use of a caliper to measure the rebar diameter. Set this value into the Profoscope and proceed.

5.4.5 Diameter Measurements on Welded Reinforcement Meshes

In most cases a diameter can be measured but the displayed value is far too high and cannot be used. The only way to determine the diameter is by an inspection hole as described under 5.4.4 above.

6. Settings

6.1 Navigating through the Settings Menu

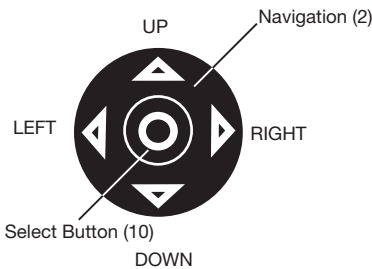

The settings menu can be entered by pressing the Select Button (10). Use the Navigation (2) to select the desired menu icon and press the Select Button (10) again.

Fig 30: Navigation with the keys (2) and (10)

Scroll within the menus to the setting you wish to make and press the Select Button (10) to implement it. To go back to the main menu press the Select Button (10) In case all settings are done or to exit from the main menu press either the Reset Key (3) or Function Key (6). In either case the measuring field appears on the display. You are ready for the measurements. Each menu item is described in detail below.



Icon only in Profoscope

Fig 31: Main menu icons

6.2 Regional Setting

 The Profoscope supports four regional settings. This setting affects all other displays and should be done prior to making other selections.

Metric	Cover and bar diameters in mm according to table in 6.3
ASTM inch	Cover in inch, bar diameters according to table in 6.3
ASTM mm	Cover in mm, bar diameters according to table in 6.3
Japanese	Cover in mm, bar diameters according to table in 6.3



6.3 Rebar Diameter

 Based on the regional setting, the bar diameter menu supports following bar dimensions.

Metric		ASTM			Japanese	
Bar size	Diam. (mm)	Bar size	Diam. (inch)	Diam. (mm)	Bar size	Diam. (mm)
5	5	#2	0.250	6	6	6
6	6	#3	0.375	10	9	9
7	7	#4	0.500	13	10	10
8	8	#5	0.625	16	13	13
9	9	#6	0.750	19	16	16
10	10	#7	0.875	22	19	19
11	11	#8	1.000	25	22	22
12	12	#9	1.125	29	25	25
14	14	#10	1.250	32	29	29
16	16	#11	1.375	35	32	32
18	18	#12	1.500	38	35	35
20	20	#13	1.625	41	38	38
22	22	#14	1.750	44	41	41
25	25	#15	1.875	48	44	44
28	28	#16	2.000	51	48	48
32	32	#18	2.250	57	51	51
36	36				57	57
40	40					
44	44					
50	50					

Tab. 2 Rebar diameters

6.4 Measuring Range Selection

	Auto Standard*	< 80 mm	< 3 inch
	Auto Large*	< 180 mm	< 7 inch
	Standard	< 80 mm	< 3 inch

*The Profoscope measures first in the “Auto Standard” range. It switches automatically from “Auto Standard” to “Auto Large” if the signal becomes too weak.

The range “Standard” must be set, when measuring over welded wire meshes.

6.5 Audio Setting

 The device can give an audible tone to assist in location or to give an alarm when minimum cover alert is activated.

-	No audio signals, silent
Centre	Key pressed. Tone when rebar is centered. Minimum cover alert.

6.6 Minimum Cover

 If a minimum cover is selected, the LED is lit when the cover is below this limit. If audio is on, an audio signal is given.

The minimum cover setting is possible with a cover up to 180 mm / 7.08”.

Metric, ASTM mm, Japanese		ASTM inch	
-	mm	-	inch
5	mm	0.20	inch
6	mm	0.24	inch
7	mm	0.28	inch
---		---	
179	mm	7.04	inch
180	mm	7.08	inch

Tab. 3 Minimum covers

6.7 Neighboring Bar Compensation

 Cover and bar diameter measurements are influenced by neighboring bars. This can be compensated by selecting the bar spacing.

Metric, ASTM mm, Japanese		ASTM inch	
-	mm	-	inch
50	mm	2.0	inch
60	mm	2.4	inch
70	mm	2.8	inch
80	mm	3.2	inch
90	mm	3.6	inch
100	mm	4.0	inch
110	mm	4.4	inch
120	mm	4.8	inch
130	mm	5.2	inch

Tab. 4 Spacings for neighbor bar corrections

The space setting is possible with a spacing from 50 mm to 130 mm / 2.0" to 5.2".
For larger spacing the compensation is not necessary and the space value must be set to zero (-).

6.8 Memory Function (for Profoscope+ only)

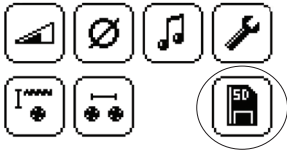

Fig 32: Main menu icons of Profoscope+

Select memory card symbol to activate the data storage mode. Minimum cover function is automatically deactivated if the memory function is turned on.

Two different memory functions are supported:



Fig 33: Sub menu "Memory"

After selecting the memory function, the status line on the measuring screen is modified:

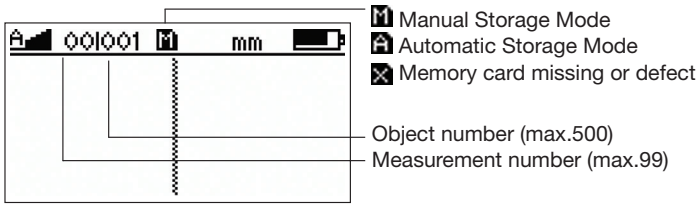

Fig 34: Display of memory functions

It is recommended to set up a separate object for each structural element (e. g. column, wall). Every measuring position on this object can then be assigned to a measurement number.

6.8.1 Manual Storage Mode:

After locating a rebar (the Rifle Scope is on the Center Line (9) and the LED Indicator (5) is lit), the cover value and the rebar diameter can be stored by pressing the Function Key (6). This procedure must be repeated for each rebar.

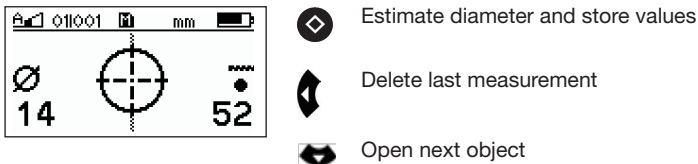

Fig 35: Display of manual storage

6.8.2 Automatic Storage Mode:

This mode is used for surface scans.

Position the Profoscope with the Center Line (9) parallel to the rebars of which the cover will be stored. Press the Function Key (6) and start moving sideways over the rebars.

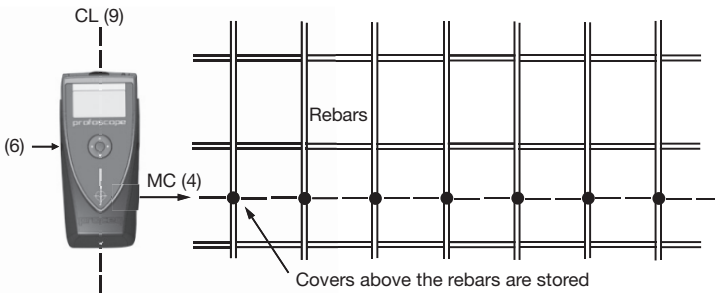

Fig 36: Automatic storage of covers

Every time a rebar is detected, the cover value is stored automatically.

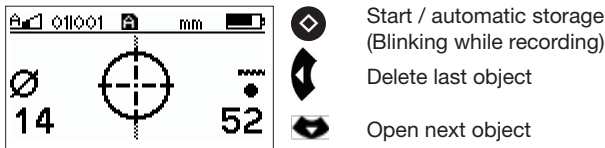

Fig 37: Display of automatic storage

The rebar diameter is not stored in automatic mode

7. Technical Specifications

Power supply	
Power source	2 x 1.5 V AA (LR6) batteries
Voltage range	3.6 V to 1.8 V
Current Consumption	
Power on, backlight off	~ 50 mA
Power on, backlight on	~ 200 mA
Sleep mode	~ 10 mA
Power off	< 1 μ A
Battery Lifetime	
Backlight off	> 50 h
Backlight on	> 15 h
Time Outs	
Sleep mode	90 s
Auto shut down	120 s
Environmental Conditions	
Temperature range	-10° to 60° C / 14° to 140° F
Humidity range	0 to 100% rH
IP classification	IP54
Conformity	CE, RoHS and WEEE
Memory (for Profoscope+ only)	
Memory Capacity	49'500 Measurements

8. Standards and Guidelines

8.1 Standards

The Profoscope is designed according to the following standards:

British:	BS 1881 part 204,
German:	DIN1045
Swiss:	SN 505 262

8.2 Guidelines

The non-destructive rebar detection method is described in the German guide line B2 of the DGZfP (Deutsche Gesellschaft zum zerstörungsfreien Prüfen, German society of non destructive testing).



9. Part Numbers and Accessories

Part Number	Item
391 10 000	Profoscope incl. standard accessories (Packaging with integrated start-up test kit, batteries, canvas bag, carrying strap, chalk and product documentation).
391 20 000	Profoscope+ incl. standard accessories (Packaging with integrated start-up test kit, batteries, canvas bag, carrying strap, chalk, product documentation and ProfoLink software).
Standard Accessories Delivered	
391 80 100	Canvas bag
350 74 025	Battery type AA
391 80 110	Carrying strap
Optional Accessories	
391 10 121S	Self-adhesive protection covers (Set of 3)
390 00 270	Calibration test block
325 34 018S	Chalk (Set of 10)
Extended Warranty	
391 88 001	Additional 1-year warranty *
391 88 002	Additional 2-year warranty *
391 88 003	Additional 3-year warranty *
* See 10.3	

10. Maintenance and Support

10.1 Protective Cover and Batteries

In order to prevent abrasion the instrument is protected by a self-adhesive protective cover. It is recommended to check and replace this cover periodically.

Remove the two AA-batteries when the Profoscope is not used for longer periods to prevent damages due to battery leakage.

10.2 Support Concept

Proceq is committed to providing a complete support service for this instrument. It is recommended that the user register the product on the www.proceq.com to obtain valuable information on available updates and other useful information.

10.3 Standard Warranty and Extended Warranty

The standard warranty covers the electronic portion of the instrument for 24 months and the mechanical portion of the instrument for 6 months. An extended warranty for one, two or three years for the electronic portion of the instrument may be purchased up to 90 days of date of purchase.

11. Quick Reference Guide for ProfoLink (for Profoscope+ only)

11.1 Installation

Locate the file „Profolink_Setup“ on your computer or the CD and follow the installation wizard. Open the Battery Compartment and connect the Profoscope+ to the USB port. If the icon  appears on the Profoscope+ screen, the connection is established properly.

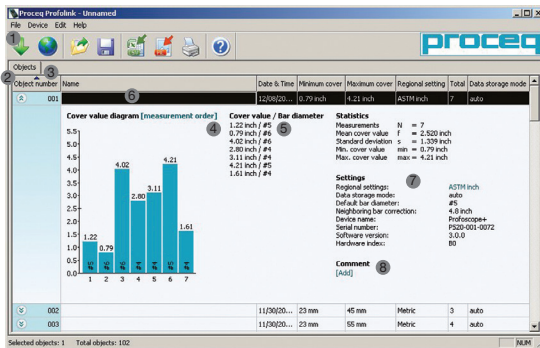

Fig 38: Profolink PC-Windows

- 1 Download objects from the Profoscope+
- 2 Expand object to see details
- 3 Measurement number
- 4 Cover value
- 5 Rebar diameter
- 6 Add object name
- 7 Switch between regional settings or units
- 8 Add comments

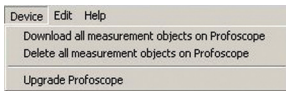

Fig 39: Profolinke Menu “Device”

Select the menu “delete all objects” to delete all data stored on Profoscope+. This will delete all objects and cannot be undone.

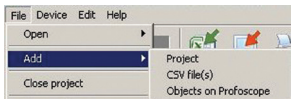
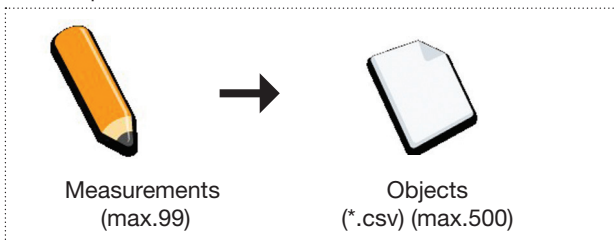

Fig 40: Profolinke Menu “File”

“Add” function synchronizes data between PC and Profoscope+. In addition, locally stored data files can be added to an existing project.

11.2 Data Management and File structure:

Profoscope



PC / Profolink

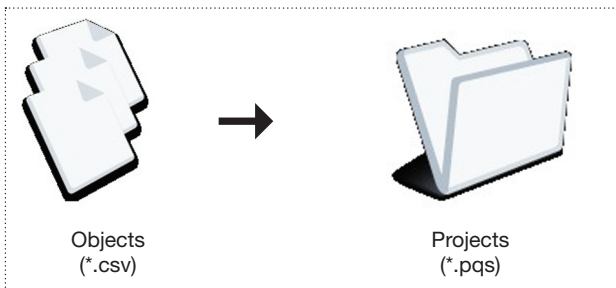

Fig 41: Data Management

Proceq Europa

Ringstrasse 2
CH-8603 Schwerzenbach
Telefon +41-43-355 38 00
Fax +41-43-355 38 12
info-europe@proceq.com

Proceq UK Ltd.

Bedford i-lab, Priory Business Park
Stannard Way
Bedford MK44 3RZ
Vereinigtes Königreich
Telefon +44-12-3483-4515
info-uk@proceq.com

Proceq USA, Inc.

117 Corporation Drive
Aliquippa, PA 15001
Telefon +1-724-512-0330
Fax +1-724-512-0331
info-usa@proceq.com

Proceq Asia Pte Ltd

12 New Industrial Road
#02-02A Morningstar Centre
Singapur 536202
Telefon +65-6382-3966
Fax +65-6382-3307
info-asia@proceq.com

Proceq Rus LLC

Ul. Optikov 4
Korp. 2, Lit. A, Office 412
197374 St. Petersburg
Russland
Telefon/Fax + 7 812 448 35 00
info-russia@proceq.com

Proceq Middle East

P. O. Box 8365, SAIF Zone,
Sharjah, Vereinigte Arabische Emirate
Telefon +971-6-557-8505
Fax +971-6-557-8606
info-middleeast@proceq.com

Proceq SAO Ltd.

South American Operations
Alameda Jaú, 1905, cj 54
Jardim Paulista, São Paulo
Brasilien Cep. 01420-007
Telefon +55 11 3083 38 89
info-southamerica@proceq.com

Proceq China

Unit B, 19th Floor
Five Continent International Mansion, No. 807
Zhao Jia Bang Road
Shanghai 200032
Telefon +86 21-63177479
Fax +86 21 63175015
info-china@proceq.com

Subject to change. Copyright © 2014 by Proceq SA, Schwerzenbach. All rights reserved.
Part Number: 820 391 01E ver 11 2014, Firmware Version 3.0.1, Profolink Version 1.0.1