

Programmable DC Electronic Load

PEL-2000 Series

USER MANUAL

GW INSTEK PART NO. 82EL-20040MA1



ISO-9001 CERTIFIED MANUFACTURER

GW INSTEK

March 2010

This manual contains proprietary information, which is protected by copyright. All rights are reserved. No part of this manual may be photocopied, reproduced or translated to another language without prior written consent of the Good Will company.

The information in this manual was correct at the time of printing. However, Good Will continues to improve products and reserves the right to change specification, equipment, and maintenance procedures at any time without notice.

Table of Contents

SAFETY INSTRUCTIONS	5
GETTING STARTED.....	10
Main Features	12
Series Overview	13
Package Contents and Accessories.....	15
Measurement Overview	16
Front Panel Overview.....	17
Display Overview – Mainframe	22
Rear Panel Overview	25
Front Panel Overview – Load Module...	28
LED Display Overview – Load Module..	32
Installation	35
Load Connections	43
Frame Link Connection	54
Channel Control Connection	56
Go/NoGo Connection	59
OPERATING DESCRIPTION.....	60
Operating Mode Description	61
Run Program.....	71
Sequence	74
Parallel Dynamic Loading	78
Configurations Description	79
Interface and File System.....	89
TUTORIALS.....	96
Local loads	97
Single Channel Load	99
Programming.....	101
Sequences.....	103

Frame Link	104
Channel Control	106
General Configuration Options	108
OPERATION	109
Local Mode Operation	112
Mainframe Basic Operation	119
Channel Configuration	160
Mainframe Configuration	180
Interface Configuration (settings)	195
Save / Recall	201
INTERFACE	232
Interface Configuration	233
FAQ	241
APPENDIX	242
Fuse Replacement	242
Battery Replacement	243
Firmware Update	244
Calibration	245
Range Chart	246
Default Settings	251
Specifications	253
Dimensions	261
EC Declaration of Conformity.....	263
INDEX.....	264

S SAFETY INSTRUCTIONS

This chapter contains important safety instructions that you must follow when operating the PEL-2002/PEL-2004, and when keeping it in storage. Read the following before operating the PEL-2002/2004 to ensure your safety and to keep the PEL-2000 series in the best possible condition.

Safety Symbols

These safety symbols may appear in this manual or on the PEL-2002/2004.



WARNING

Warning: Identifies conditions or practices that could result in injury or loss of life.



CAUTION

Caution: Identifies conditions or practices that could result in damage to THE PEL-2002/2004 or to other properties.



DANGER High Voltage



Attention Refer to the Manual



Protective Conductor Terminal



Earth (ground) Terminal



Do not dispose electronic equipment as unsorted municipal waste. Please use a separate collection facility or contact the supplier from which this instrument was purchased.

Safety Guidelines

General Guideline



CAUTION

- Do not place any heavy object on the PEL-2002/2004.
- Avoid severe impact or rough handling that leads to damaging the PEL-2002/2004.
- Do not discharge static electricity to the PEL-2002/2004.
- Do not block or obstruct the cooling fan vent openings.
- Do not perform measurement at circuits directly connected to Mains (Note below).
- Do not disassemble the PEL-2002/2004 unless you are qualified as service personnel.
- The equipment is not for measurements performed for CAT II, III and IV.

(Measurement categories) EN 61010-1:2001 specifies the measurement categories and their requirements as follows. The PEL-2002/2004 falls under category I.

- Measurement category IV is for measurement performed at the source of low-voltage installation.
 - Measurement category III is for measurement performed in the building installation.
 - Measurement category II is for measurement performed on the circuits directly connected to the low voltage installation.
 - Measurement category I is for measurements performed on circuits not directly connected to Mains.
-

Power Supply**WARNING**

- AC Input voltage: 115V/230V switchable, 50/60Hz
 - The power supply voltage should not fluctuate more than 15%.
 - Connect the protective grounding conductor of the AC power cord to an earth ground, to avoid electrical shock.
-

Fuse**WARNING**

- Fuse type: T3.15A/250V
 - Make sure the correct type of fuse is installed before power up.
 - To avoid fire, only replace the fuse with the specified type and rating.
 - Disconnect the power cord before fuse replacement.
 - Make sure the cause of a fuse blowout is fixed before replacing the fuse.
-

Battery**WARNING**

- Battery type: CR17345 (See page 243).
 - When replacing the battery ensure that the correct make and model are used.
-

**Cleaning the
PEL-2000**

- Disconnect the power cord before cleaning.
 - Use a soft cloth dampened in a solution of mild detergent and water. Do not spray any liquid.
 - Do not use chemicals or cleaners containing harsh material such as benzene, toluene, xylene, and acetone.
-

**Operation
Environment**

- Location: Indoor, no direct sunlight, dust free, almost non-conductive pollution (Note below)
- Temperature: 0°C to 40°C
- Altitude: Up to 2000m
- Transient Overvoltage on the main supply is 2500V.

(Pollution Degree) EN 61010-1:2001 specifies the pollution degrees and their requirements as follows. THE PEL-2002/2004 falls under degree 2.

Pollution refers to “addition of foreign matter, solid, liquid, or gaseous (ionized gases), that may produce a reduction of dielectric strength or surface resistivity”.

- Pollution degree 1: No pollution or only dry, non-conductive pollution occurs. The pollution has no influence.
- Pollution degree 2: Normally only non-conductive pollution occurs. Occasionally, however, a temporary conductivity caused by condensation must be expected.
- Pollution degree 3: Conductive pollution occurs, or dry, non-conductive pollution occurs which becomes conductive due to condensation which is expected. In such conditions, equipment is normally protected against exposure to direct sunlight, precipitation, and full wind pressure, but neither temperature nor humidity is controlled.

**Storage
environment**

- Location: Indoor
- Relative Humidity: < 80%
- Temperature: -10°C to 70°C

Disposal

Do not dispose this instrument as unsorted municipal waste. Please use a separate collection facility or contact the supplier from which this instrument was purchased. Please make sure discarded electrical waste is properly recycled to reduce environmental impact.

Power cord for the United Kingdom

When using the PEL-2002/2004 in the United Kingdom, make sure the power cord meets the following safety instructions.

NOTE: This lead/appliance must only be wired by competent persons



WARNING: THIS APPLIANCE MUST BE EARTHED

IMPORTANT: The wires in this lead are coloured in accordance with the following code:

Green/ Yellow:	Earth
Blue:	Neutral
Brown:	Live (Phase)



As the colours of the wires in main leads may not correspond with the coloured marking identified in your plug/appliance, proceed as follows:

The wire which is coloured Green & Yellow must be connected to the Earth terminal marked with either the letter E, the earth symbol (⊕) or coloured Green/Green & Yellow.

The wire which is coloured Blue must be connected to the terminal which is marked with the letter N or coloured Blue or Black.

The wire which is coloured Brown must be connected to the terminal marked with the letter L or P or coloured Brown or Red.

If in doubt, consult the instructions provided with the equipment or contact the supplier.

This cable/appliance should be protected by a suitably rated and approved HBC mains fuse: refer to the rating information on the equipment and/or user instructions for details. As a guide, a cable of 0.75mm² should be protected by a 3A or 5A fuse. Larger conductors would normally require 13A types, depending on the connection method used.

Any exposed wiring from a cable, plug or connection that is engaged in a live socket is extremely hazardous. If a cable or plug is deemed hazardous, turn off the mains power and remove the cable, any fuses and fuse assemblies. All hazardous wiring must be immediately destroyed and replaced in accordance to the above standard.

G E T T I N G S T A R T E D

This chapter describes the features and functions of the PEL-2002/2004, including the front and rear panel appearance, panel installation and connection types. Use the Tutorial section for quick access to step by step instructions on the main functions.



Main Features	12
Series Overview.....	13
Package Contents and Accessories	15
Measurement Overview.....	16
Front Panel Overview	17
Display Overview – Mainframe	22

Rear Panel Overview.....	25
Front Panel Overview – Load Module.....	28
LED Display Overview – Load Module	32
Installation	35
Load Module Installation	35
GPIB Installation	38
Rack Mount Installation.....	39
Channel Number.....	40
Power Up & Self Test	41
Load Connections	43
Precautions and Procedures	43
Remote (Sense) Connection.....	48
Single Load Connections.....	50
Parallel Load Connections.....	52
Frame Link Connection.....	54
Channel Control Connection.....	56
Go/NoGo Connection	59

Main Features

Description The PEL-2002 and 2004 are multichannel programmable DC electronic load mainframes. The PEL-2002 mainframe is able to hold 2 load modules, whilst the PEL-2004 is able to hold 4. The flexible module configuration allows the mainframes to either sink multiple loads independently or large loads when used in parallel.

The PEL-2000 series support three operation modes: constant current (CC), constant voltage (CV and CV+CC) and constant resistance (CR). Constant current and constant resistance mode can operate in either static or dynamic mode.

-
- Feature Overview**
- Flexible operation with removable load modules
 - Multiple independent isolated channels
 - High performance, up to 5 digit resolution
 - High slew rate enabling a high response speed
 - High capacity when frame linked
 - Different load module types can be used in the same mainframe
 - Supports rack mount installation (PEL-2004)
 - Supports frame link connections, with up to 4 slave units
 - Color LCD display
 - 120 different sets of programmable sequences
 - Accurate load simulation using Sequences
 - 4 panel setups
 - USB flash drive support
-

Interface	<ul style="list-style-type: none">• USB• RS-232C• GPIB (optional)
-----------	---

Series Overview

The PEL-2000 series comprises of two different Mainframes: the PEL-2002 and the PEL-2004. The Mainframes differ by the number of load modules that can be accommodated. The PEL-2002 has two load module slots whilst the PEL-2004 has 4. There are 4 different load module models, the PEL-2020, PEL-2030, PEL-2040 and PEL-2041.

PEL-2004

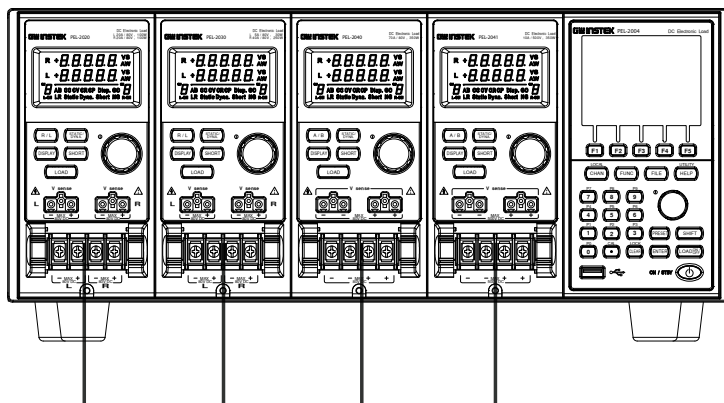

PEL-2020 PEL-2030 PEL-2040 PEL-2041

PEL-2002

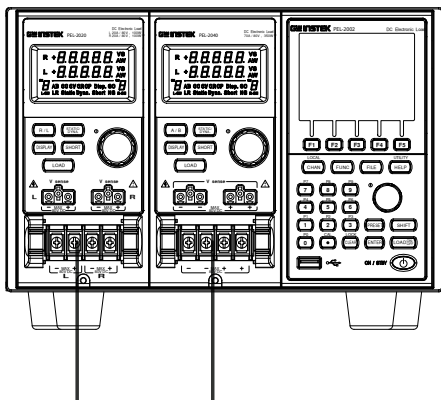

PEL-2020 PEL-2040

The 4 different load module models each differ in the amount of current, voltage and power and the amount of channels that the load module can accommodate. The procedures in this manual will be load module model independent unless specifically stated. Below is a table showing the basic differences between each load module model. For detailed specifications, please see page 253.

Load Module	Channels	Power (W) CH L/R	Current (A) Range Low/High	Voltage (V)
PEL-2020 (100Wx2)	2	100/100	2/20	1-80
PEL-2030 (30/250W)	2	30/250	5/4/40	1-80
PEL-2040	1	350	7/70	1-80
PEL-2041	1	350	1/10	2.5-500

Package Contents and Accessories

The PEL-2000 electronic load generator has a number of standard and optional accessories that can be ordered. For more information please visit the GW Instek website at www.gwinstek.com or consult your authorized distributor for details.

Standard Accessories	Description
Power Cable	Mains power cable (region dependent)
User Manual	PEL-2000 Series Electronic DC load User Manual (region dependent)
GTL-120	Load cables 2X red, 2X black (per load module)
GTL-121	Remote sense cables , 1X red, 1X black (per load module)

Options	Description
PEL-2020	Load Module
PEL-2030	
PEL-2040	
PEL-2041	
PEL-001	GPIB interface (Factory installed)

Optional Accessories	Description
PEL-002	PEL-2000 Rack Mount kit (handle only)
GTL-232	RS-232C
GTL-246	USB
GTL-248	GPIB cable
GTL-249	Frame link

Measurement Overview

The PEL-2000 series has a number of different operating modes that are completely configurable. All the modes have customizable Go/NoGo limits, range limits, timers, slew rates, alarms and protection limits. To make tests, Programs and Sequences can be created.

Function	Description
Constant Current Mode (CC)	In constant current mode, the PEL-2002/2004 will sink a constant amount of current, regardless of the voltage.
Constant Voltage Mode (CV)	Under constant voltage mode, the voltage remains unchanged, regardless of the current.
Constant Resistance Mode (CR)	In constant resistance mode, the resistance load will remain unchanged as the voltage and current remain proportional.
Programmable Sequences (Prog.)	The PEL 2000 series supports programming sequences. With up to 120 different memory settings in 12 programs with 10 sequences.
Sequences (Seq.)	Used to create load profiles to accurately simulate a load. Sequences can be created for each channel.

Front Panel Overview

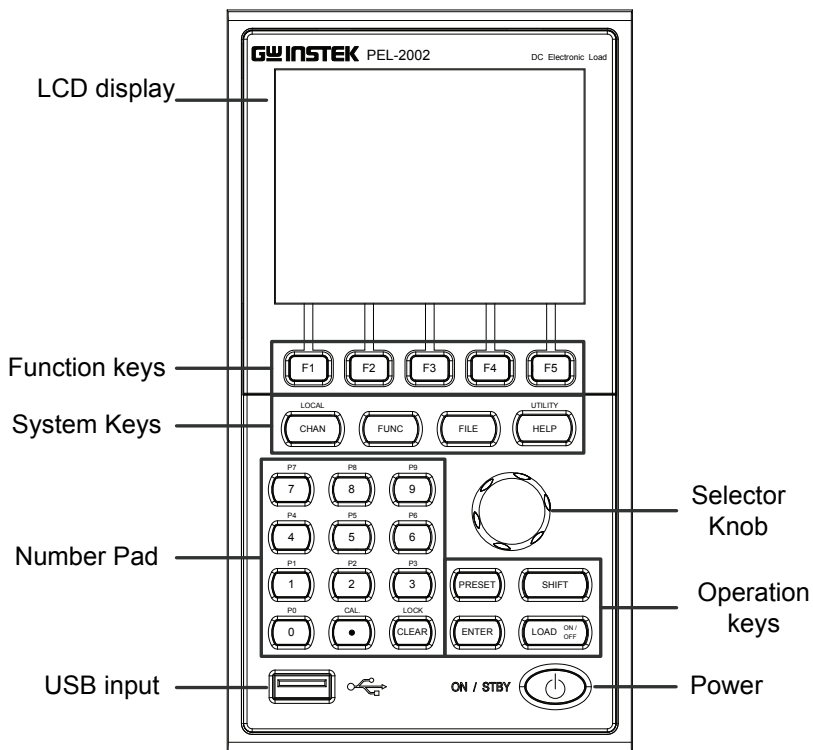



LCD display 320 by 240, TFT LCD display.

Function keys  ~  Assigned to the menu functions on the bottom of the display.

System Keys

LOCAL
 CHAN/LOCAL is used to select the load channel. Combined with the shift key, Local is used to activate/deactivate local control (during remote control via the interface or frame link connections).

LOCAL
 Brings up the Channel Menu.

  Used to activate local control mode during remote control via the interface

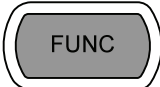
 Used to access the Program or Sequence menu.

 Used to access the File menu.

UTILITY
 Brings up the Help menu and utility menu.

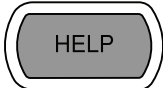
UTILITY
 Provides help for the last function /key pressed.

  Activates the Utility Menu.

Number pad

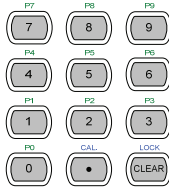

Enter numerical values, or to save/recall presets (P0-P9).

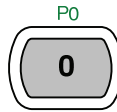

Number values.

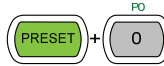

Preset numbers P0-P9.

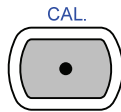

Decimal point and Calibration key

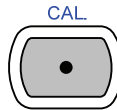

Decimal point.

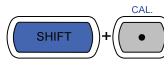

Activate calibration mode.



Note

Please note, calibration mode is not supported. Please see your distributor for calibration needs.



Clears current values. Alternative function locks the keys and the Selector knob.



Clears the current value.



Locks all the keys and Selector knob.

USB Input



USB flash memory slot.

Selector Knob

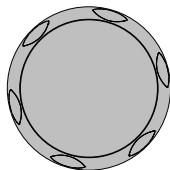

Used to select operations and to increase/decrease values.

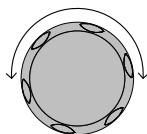

When turned left or right moves the cursor in menus or changes the selected item or value.

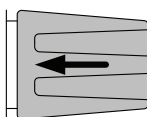

When pushed down, acts as the Enter key.

Operation Keys



Saves and recalls preset settings and values.

When pressed in combination with the number pad, Presets P0-P9 can be recalled or saved.



Inactive



Active. Used in combination with the number pad and/or shift key.



Press to recall a channel preset

Hold to save a channel preset

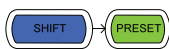

Press to recall all channel presets.

Hold to save all channel presets.



The shift key is used to access alternate functions assigned to select keys

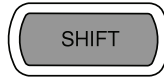

Inactive



Active. When active the shift key can be used to access the Local and Utility menus.



Confirms selections.



Turns the current load/channel on or off



Load is currently off. (unlit)



Load is currently on. (orange light)

Power



Turns the unit on or into standby mode.



Standby mode.



On.

Display Overview – Mainframe

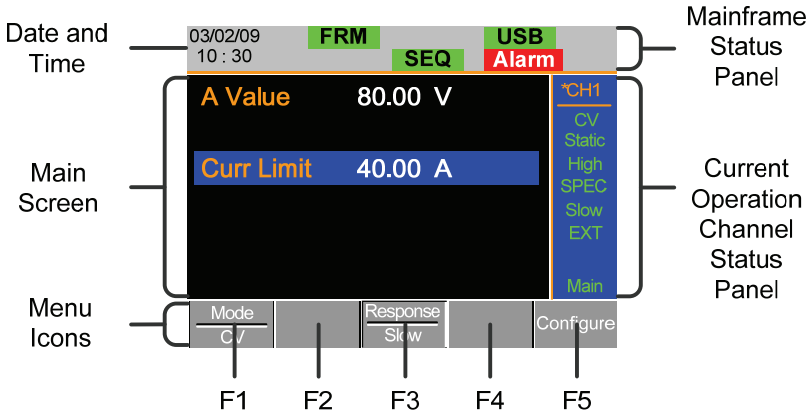

Mainframe Status Panel The Mainframe Status Panel displays the status of the Mainframe interface, programs and alarm status.

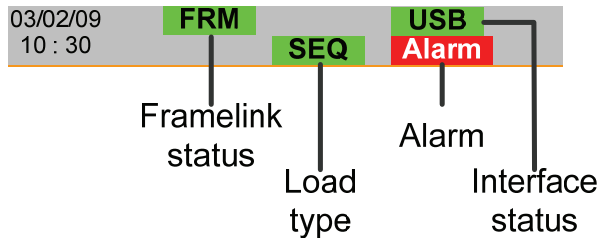

Frame Link Status **FRM** Indicates Frame Link is turned on and that the mainframe is set as either a master (FRM) or slave (FRS) unit.

Load Type

The Load Type Icon indicates if a Sequence (SEQ) or Program (PROG) is turned on. If not then LOAD is displayed as default. When any Load type is running, their icon will turn orange.

Interface Status

The interface status icon displays which interface type is set.

Current Operation Channel Status Panel

The Current Operation Channel Status panel generally displays the status of the current channel.

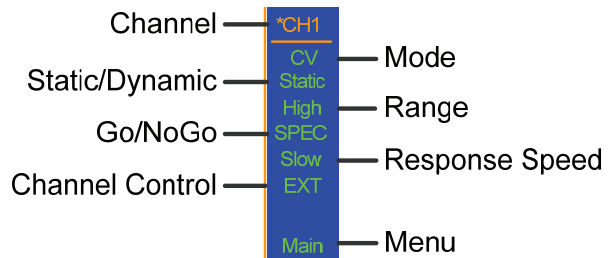

Channel

*CH1~
*CH8

Displays the current channel. An asterisk * denotes independent mode for the channel.

Mode	CC CR CV	Displays the current mode.
Static / Dynamic		Displays whether the channel is in Static or Dynamic mode.
Range	High Low	Displays High or Low range.
Go/NoGo	SPEC	If Go/NoGo is turned on, SPEC will be displayed.
Response Speed	Slow Fast	In CV mode the response speed will be shown, Slow or Fast.
Channel Control	EXT	When Channel Control is set to External, EXT will be displayed.
Menu	Main Conf s_edit File s_loop	Shows the current menu. = Chan menu = Chan→Configure menu = Chan→Seq.Edit menu = File menu = Chan→Seq.Edit→Loop menu
Date and Time	03/02/09 10 : 30	The date is displayed as Month/Day/Year and the time is set as a 24-hour time notation.
Main Screen	Main display screen	
Menu Icons	F1~F5	Each Menu Icon is controlled by the F1~F5 function keys directly below.

Rear Panel Overview

PEL-2004

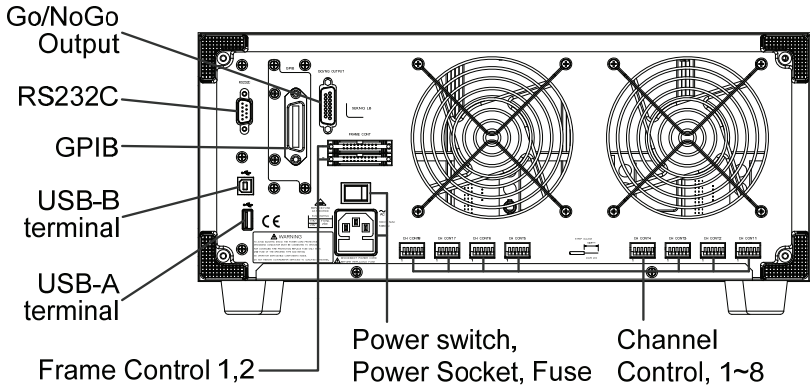

PEL-2002

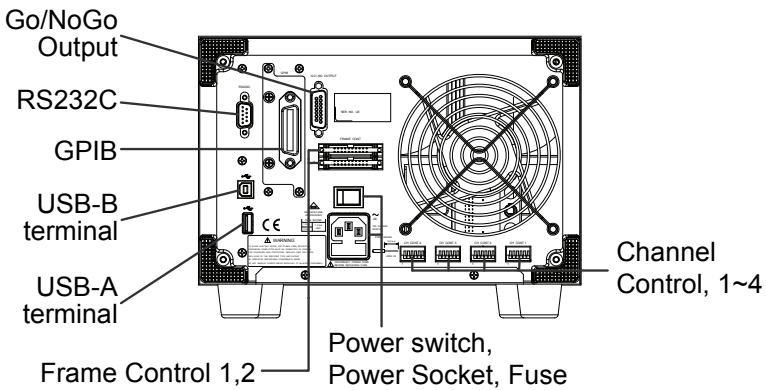

Go/NoGo Output

GO/NG OUTPUT

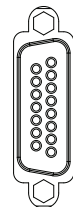

The Go/NoGo Output terminal outputs a pass (high)/fail (low) voltage for each channel.

See page 239, 59 for details.

RS232 port/
GPIB port

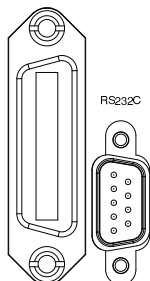

The RS232 and GPIB port is used for remote control connections.

RS-232C: DB-9 pin male

GPIB: 24-pin female

See pages 233, 234 for remote control details.

USB-A(host)/
USB-B (device)
port

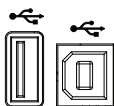

The USB-B (device) port, like the RS232/GPIB port is used for remote control. Like the front panel, the USB-A port is used for data storage.

See page 89 for interface details.

Frame Control
Port

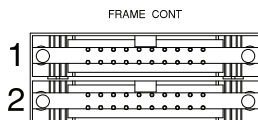

The Frame Control port is used for Frame Link connections. Mainframes are daisy-chained together. There are two Frame control ports.

1: Slave

2: Master

Connection type: MIL 20-pin connector.

For details about frame link connections see page 54, 236.

Power Switch

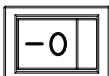

External Power Switch

Power Socket/
Fuse

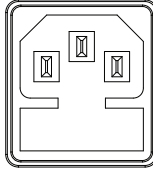

The power supply socket accepts the AC mains Voltage. The fuse holder is located below the power socket.

Power: 50/60 Hz (180 VA)

Fuse: T3.15A/250V

For fuse replacement details see page 242.

Channel
Control port
(1~8)



Each channel has a dedicated Channel control port to enable external monitoring and control. The channel control port has 6 wire sockets that are screw-less and self clamping.

Required wire gauge: 24 AWG

For connection or specification details see pages 56 & 235.

Front Panel Overview – Load Module

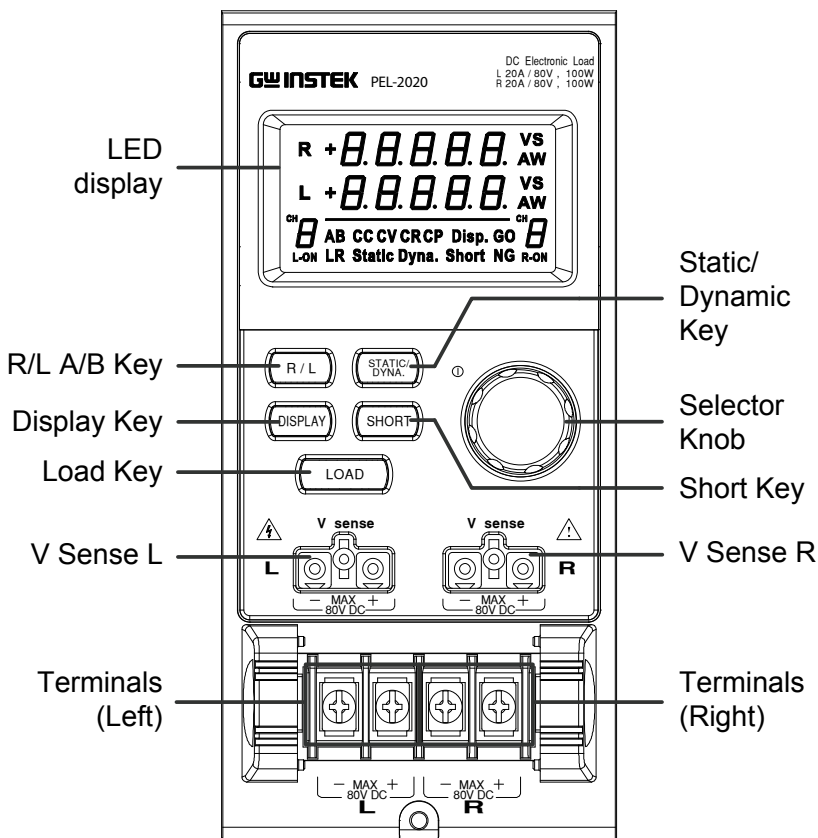

LED display

2x5 digit custom LED display.

Right/Left Key
or
A/B Key



The L/R key is used to switch between the right and left load channel on a dual channel load module. The A/B key is used to switch between A&B Values for single channel load modules.

Display Key



Used to alternate the display output on the load module.

Current

Voltage

Power

Load time

Load Key



Activates the load for the active channel. (Right or Left)(A or B)

Left Voltage Sense

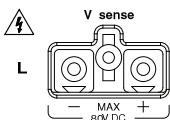

The voltage sense terminals are used when precise measurement is needed. V Sense terminals are used to compensate for voltage drops across the main terminals caused by the resistance of the load wires.

Right Voltage Sense

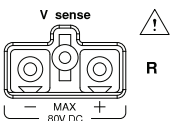

It is automatically activated when connected to a DUT.

Positive and Negative Terminals Left

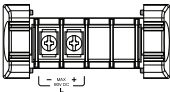

The terminals for both the left and right side of a load can draw differing amounts depending on the load module specifications.

Positive and Negative Terminals Right

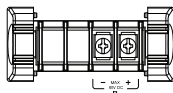

For 2 channel load modules, the left terminals are used for the 1st channel and the right terminals are used for the 2nd channel.

On single channel load modules, the left terminals are the lower (-) potential terminals, whilst the right terminals are the positive (+) potential terminals.

Static/Dynamic Selector Key



The STATIC/DYNA. Key manually switches the load from Static (manual) to Dynamic loads.

Dynamic loads are only supported in CC and CR mode. For more information see page 61 & 65.

Selector Knob (Load)

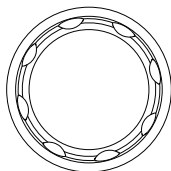

The load Selector Knob is used to edit and vary parameters for the active channel on the local load. Depending on the Mainframe setup, the Selector Knob will either only update the load (locally) or will update both the local module and the mainframe*. The Selector knob can also be configured to display measured or set values on the local load module**.

* For more information on “Knob Type”, see page 188.

** For more information on “Slave Knob”, see page 192.

Short Key



The SHORT key is used to manually short circuit the active channel on the local active load. When a load is off, the SHORT key will toggle the Short key type.



Hold: Hold the SHORT key to short the channel load.



Toggle: Press the SHORT key to toggle shorting the load on or off.

Load on: Pressing or holding the SHORT key will short the load, depending on the short type selected.

LED Display Overview – Load Module



1&2. Channel Display



R or **L** Left and right channel indicator.



5 digit display.

3&7. Channel Number Indicator



Indicates the channel number (1-8).

L-ON

Indicates if the load is active on the load module. (Dual channel load modules)

ON

Indicates if the load is on for single channel load modules.

4. Mode Indicator The Mode Indicator LEDs will indicate what the current mode or settings are on the active channel(s).

AB CC CV CR CP Disp. GO
LR Static Dyna. Short NG

- A or B** Value A or B for a single channel load module. Applies to CR, CV, and CC static mode only.
- CC** Constant Current Mode (CC) mode activated.
- CV** Constant Voltage Mode (CV) mode activated.
- CR** Constant Resistance Mode (CR).
- Disp.** Display is shown on dual channel load modules when both left (L) and right (R) channel information is displayed.
- Press the Display button repeatedly to show information for both channels.
- GO** Lights up when Go/NoGo is activated and the load passes (GO) the Go/NoGo limits.
- L or R** L or R will light up when the left or right channel is selected.
- Static** Lights up when in Static mode.
- Dyna.** Lights up when in Dynamic mode.

Short Lights up when a load is shorted.

NG Lights up when Go/NoGo is activated and the load fails (NG) the Go/NoGo limits.

5&6. Channel
Unit Indicators



The Unit Indicators display current the unit.

V Voltage

Ω Resistance

A Current

W Power

Installation

The installation chapter describes how to load the different load modules, install the optional GPIB card, the rack mount kit and how to determine each channel number.

Load Module Installation



To avoid static electricity, please use appropriate anti-static work practices.

Module
installation

The PEL-2004 and 2002 can accommodate 4 and 2 load modules, respectively. Module loads can have 1 or 2 channels. Installation of load modules is the same for both models.

Steps

1. Ensure the PEL mainframe is turned off from the rear panel. Disconnect the power cord.

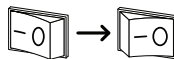

2. Slide the module onto the rails of an empty load slot.

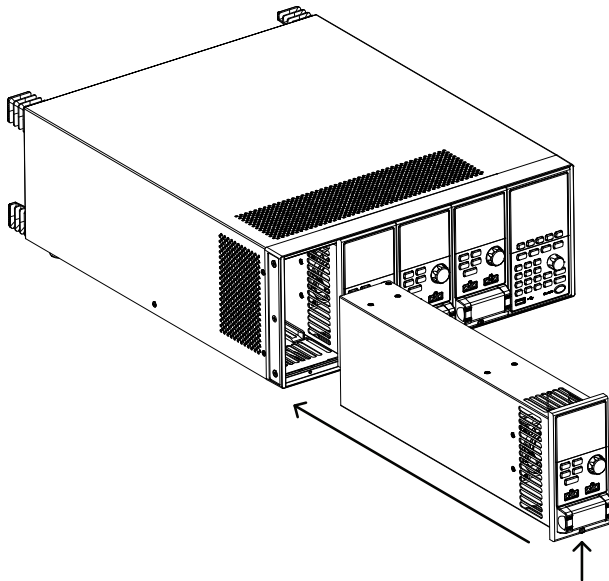

3. Use the supplied screw to fix the module to the load slot, located under the load terminals.

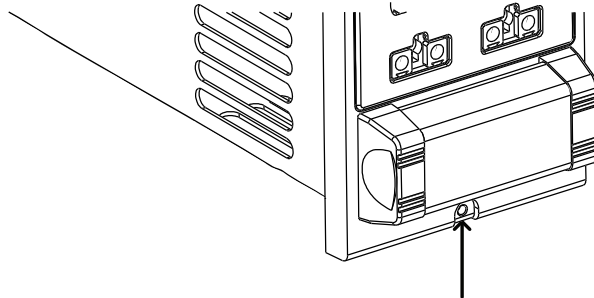

4. Install any additional modules as described above.
5. If there are any slots empty, install the supplied panel cover (GW Instek part number: 63FP-AG106501). The panel cover will improve safety and increase air flow.

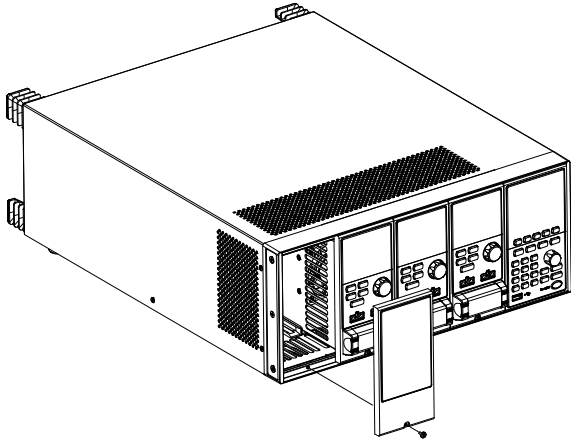

6. Use the supplied screws to fix the panel cover(s) over the load slot.

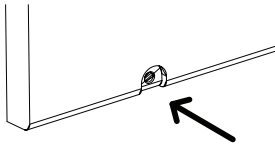

GPIB Installation



WARNING

To avoid static electricity, please use appropriate anti-static work practices.

GPIB Card installation

The PEL-2004 and 2002 has GPIB as an option (GW Instek part no. PEL-001).

Steps

1. Ensure the mainframe is disconnected from mains power.
2. Remove the screws from the GPIB cover plate and remove the cover plate from the rear panel.
3. Slide the GPIB card into the slot and push gently until the back plate is flush with the rear panel.

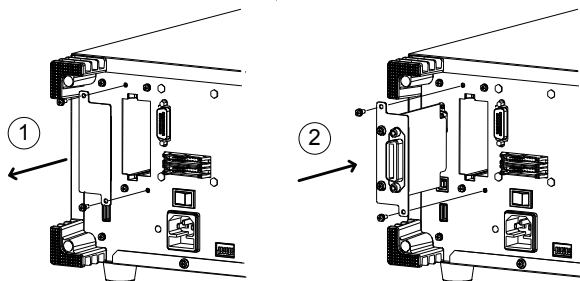

4. Use the screws that were removed from step 1 to secure the GPIB card.

Rack Mount Installation

Background The PEL-2004 can be used in a standard 19" rack mount enclosure with the optional rack mount kit (GW Instek part no. 11EL-20040201). Each unit requires a rack height of 4U with a 1U space for ventilation top and bottom. The rear of the rack mount enclosure must be free of obstruction to allow heat to dissipate from the mainframe(s).

Steps 1. Screw the rack mount brackets as shown below using the supplied bolts.

PEL-2004

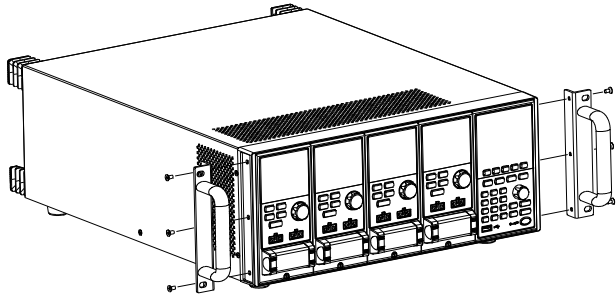

2. Insert into a standard 19" rack enclosure with at least 1U of space top and bottom for ventilation.

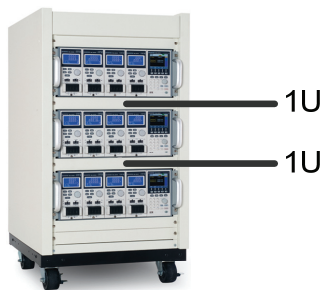

Channel Number

Description The channel number for a module load is determined by which slot it occupies on the mainframe chassis. There can be 1 or 2 channels per slot, depending on the load module type.

The PEL2002 has two slots; The PEL-2004 has 4 slots. Channel 1 is the farthest away from the main display panel and channel 8 (PEL2004) or channel 4 (PEL2002) is the closest to the main display panel.

Below the PEL-2004 has all 4 slots occupied with the PEL-2020, 2030, 2040 & 2041series load modules (LM), respectively. The PEL-2020 & 2030 have 2 channels per load module, the PEL-2040 & 2041 have only 1. So the channel determination is:

LM1: CH1,CH2; LM2: CH3,CH4; LM3: CH5; LM4: CH6.

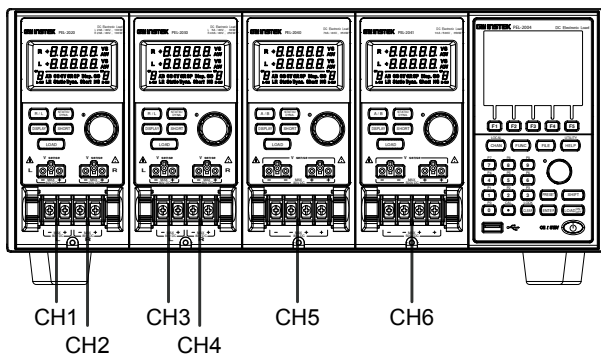

Power Up & Self Test

Panel operation

1. Connect the power cord to the power socket.

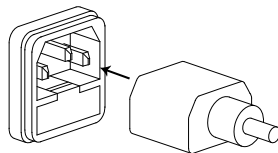

2. Turn the external power switch on.

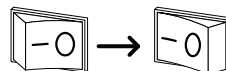

3. Hold the power button on the front panel to turn on the power.



The power button turns green from red (standby).

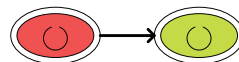

WARNING

Ensure that the power outlet has a ground socket. The power outlet will have a ground connection if it is a 3 socket type.

Upon turning on, the Mainframe will perform a self-test. The self-test checks the System, followed by any attached channels.

Initial	System	Success
	CH1	Success
	CH2	Success
	CH3	Success
	CH4	Success
	CH5	Success

When the system check happens, the load modules will display each channel as it is checked, then display the current mode.

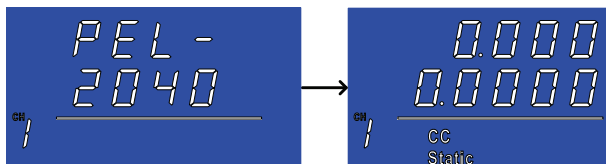

- If any of the System checks fails, please power down the load generator and reinstall the appropriate load module(s).
- To turn off the load generator, hold the power button for a few seconds.



The PEL mainframe will return to standby mode.

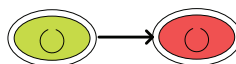

Load Connections

Precautions and Procedures

Introduction The PEL-2000 load generator supports a number of different load configurations for flexible operation.

- Single DUT, single load
- Single DUT, parallel load
- Multiple DUTs, multiple loads
- Multiple DUTs, multiple mainframe loads
- Single DUT, parallel mainframes
- DC loads
- Low voltage connections

The PEL-2000 also supports a number of different control methods and interfaces. The connections used are described here:

- Frame link
- Channel control
- Go/NoGo

Wire Gauge considerations Before connecting the PEL-2000, wire gauge must be taken into account. Load wires must be large enough to resist overheating when a short-circuit condition occurs as well as maintain a good regulation. The size, polarity and length of a wire are all factors in determining if a wire will withstand short circuiting.

Wire Selection Wires that are selected must be large enough to withstand a short circuit and limit voltage drops to no more than 2V per wire. Use the table below to help make a suitable selection.

AWG	Max Current A(Amp)
24	7.64
22	10.0
20	13.1
18	17.2
16	22.6
14	30.4
12	40.6
10	55.3

Load Line Inductance Considerations When using the PEL-2000 load generator, voltage drop and voltage generated due to load line inductance and current change must be taken into account. Extreme changes in voltage may exceed the minimum or maximum voltage limits. Exceeding the maximum voltage limit may damage the PEL-2000.

To determine the voltage generated, the following equation can be used.

$$E = L \times (\Delta I / \Delta T)$$

E= voltage generated

L=load line inductance

ΔI = change of current (A)

ΔT = time (us)

Load line inductance (L) can be approximated as 1uH per 1 meter of wire. ($\Delta I / \Delta T$) is the slew rate in A/us.

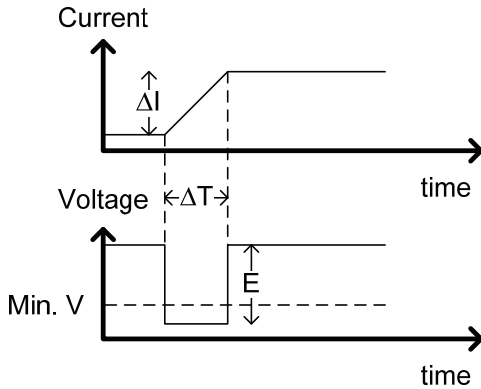

The diagram above shows how changes in current can affect voltage.

Limiting Load line inductance Load line inductance can be reduced by ensuring load wires are as short as possible and by twisting positive and negative load wires together. Current change can be limited by limiting the slew rate when switching.

“Twisted pair” will be shown on any connection diagram where the load wires should be twisted together.

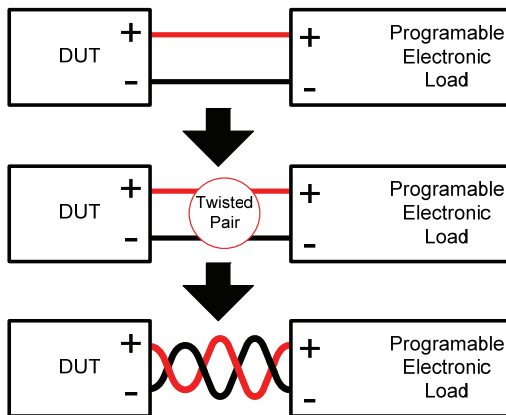

Load module considerations

The PEL-2000 supports single and dual channel load modules.

Single channel load modules have one bank of negative terminals and one bank of positive terminals. Each terminal pair has a 40A capacity. For higher loads, each terminal can be wired in parallel to increase capacity.

Dual channel load modules have one bank of positive and negative terminals for each channel.

Single Channel Load Module

Dual Channel Load Module

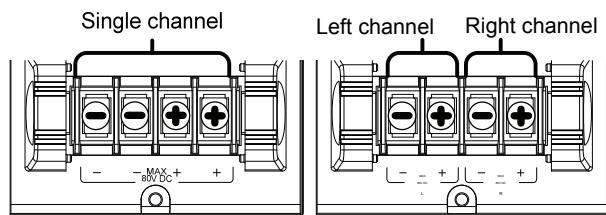

Connection

Follow the procedure below for all load connections.



CAUTION

Ensure that power is off from the load generator and the DUT before making any connections.

Steps

1. Carefully lift the terminal covers.
2. Connect the positive (+) terminal on the load module to the high potential output of the DUT.
3. Connect the negative (-) load terminal to the low potential output of the DUT.

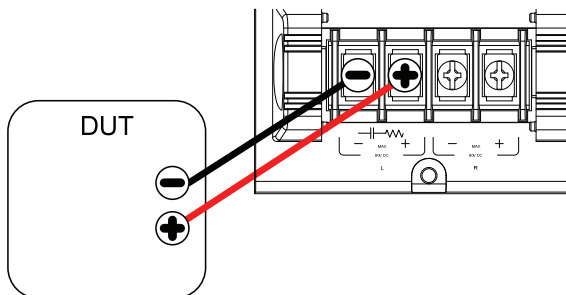

4. Close the terminal cover securely. Ensure the wires are secured properly and that the wires are not exposed when the cover is in place.



WARNING

Ensure that the wires are tied or twisted together to prevent noise and inductance.



CAUTION

Ensure the polarity is correct before proceeding with any connections. Using the wrong polarity could result in reverse voltage damage.

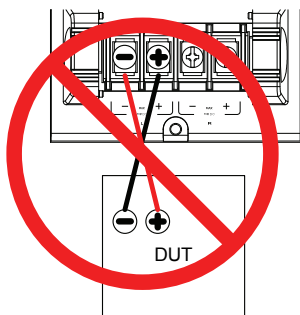

Ensure the input voltage doesn't exceed specifications. Exceeding the voltage specifications could result in damage to the instrument.

Remote (Sense) Connection

Background

The electronic load modules have two voltage sense contacts: Vsense L(black), Vsense R(red). Voltage sense can be used to help compensate for long cable length. The longer the cable, the higher the potential resistance and inductance, therefore a short cable is best. Twisting the cable can help reduce induced inductance and using the Vsense terminals compensates the voltage drop seen across the load leads, especially leads with higher resistance. This is useful when used in CV or CR mode.



WARNING

VsenseR (red) must have a higher (+) potential than VsenseL (black).

Connection

The diagram below shows how a DUT can be connected using voltage sense. Note that the sense wires are also twisted pairs.

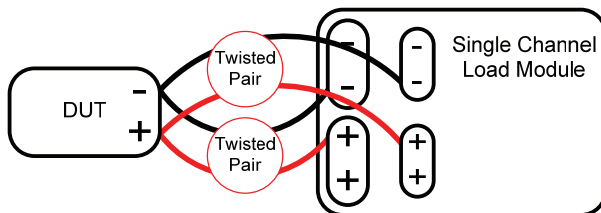

Note

The wire gauge for the sense wires should be no smaller than 16 gauge.

Input

The voltage sense terminals must use a wire gauge of 16 to 14.

Remote Sense Terminal connection

The voltage sense terminals use a screw-less clamp connector. The clamp must be opened prior to inserting a wire. Use a small screwdriver to push the clamp release mechanism. Insert both wires then release the clamp mechanism.

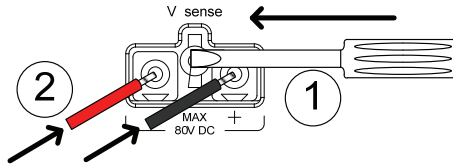

Single Load Connections

Dual Channel Load Module Connection

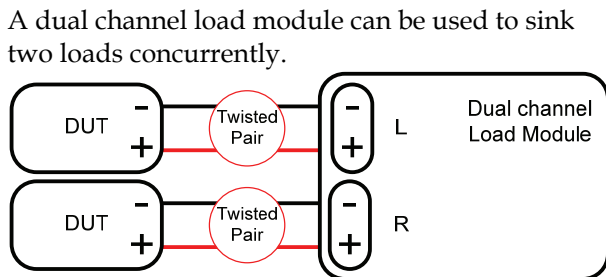

Single Channel Load Module Connection

On a single channel load module, the left terminals are both negative (-), whilst the right terminals are both positive (+). Note this also applies to the voltage sense terminals.

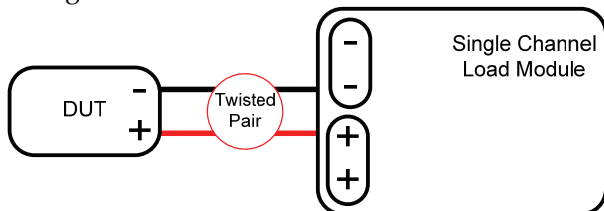

 CAUTION

For loads exceeding 40A, both positive and both negative terminals must be used in parallel.

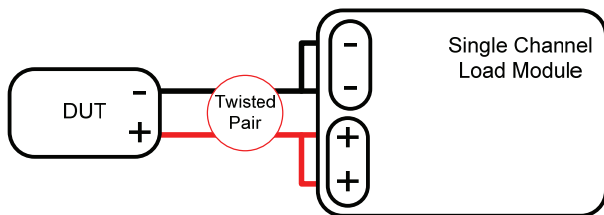

DC Connection For purely DC operation, a resistor and capacitor can be connected in parallel to the electronic load to reduce oscillation. The capacitor and resistor values are dependent on the load settings. Ensure the capacitor ripple current is within allowable limits.

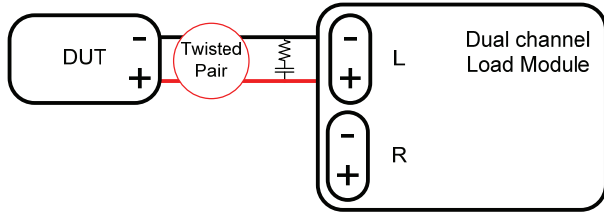

Low Voltage Connection Using the load generator with low voltage loads is generally limited to over 1 volt (load module dependent). In order to support low voltage loads, an auxiliary power supply is needed to boost the voltage to a range suitable for the load generator.

Precautions:

- Take into account the combined power of the load and auxiliary power supply.
- Make sure the auxiliary power supply is able to provide enough current.
- Take into account any noise or irregularities from the auxiliary supply.

The diagram below shows a typical connection.

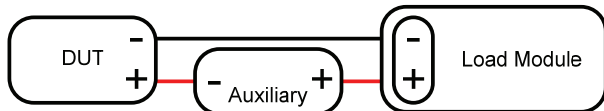

Using an auxiliary power supply may induce reverse current. The PEL-2000 series has reverse voltage protection. For details see the protection section on page 79.

Parallel Load Connections

Parallel load modules

When the power output of a DUT exceeds the power rating of a channel or load module, the channel terminals, load modules or mainframes can be used in parallel to dissipate more power when used in CC mode. Each channel will sink the amount of current specified. The total power sunk is the sum of all channels/modules. The amount of power can vary from each channel. For example if CH1 is 25A and CH2 is 20A, then the total current sunk is 45A. Parallel loads are supported for both static and dynamic loads (see page 78 for a description on parallel dynamic loading).

Parallel load

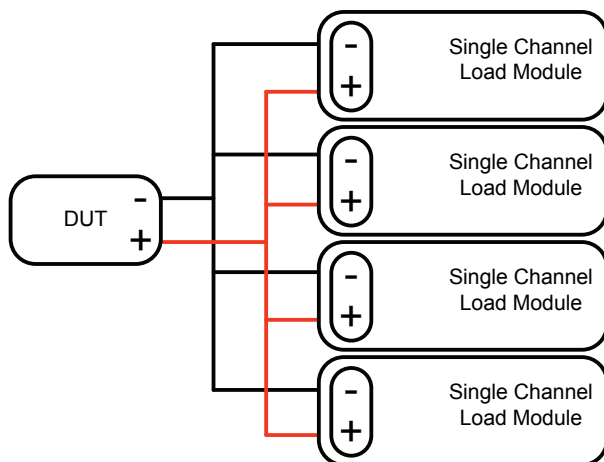

Please note that when using different load modules in parallel, the slew rates may differ. See the specifications for more details, page 253.

Parallel loads using framelink connections

The PEL-2000 mainframes can also be connected in parallel. Please note, when using a frame link connection there is a delay between the master and the slave. Please see page 54 for details.

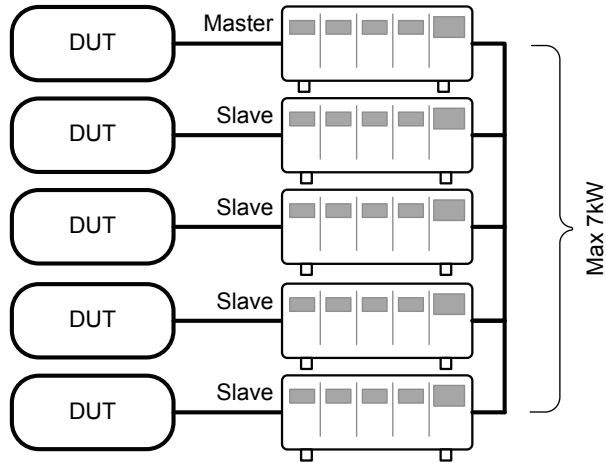

Multi-output power supply load

The PEL-2000 is also able to sink a number of loads concurrently from multiple DUTs or sink a number of loads from the same DUT (i.e. multiple output power supply).

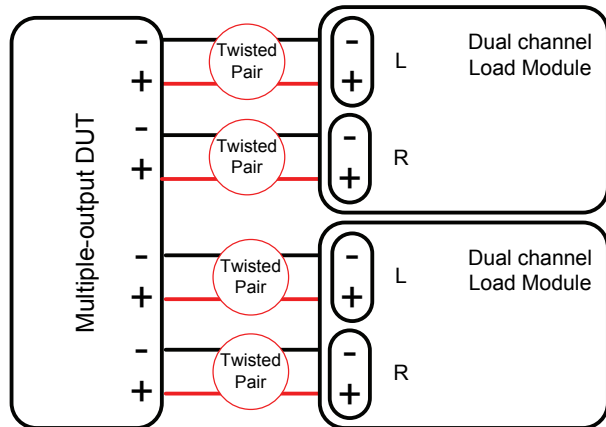

Frame Link Connection

Background

Frame link control involves connecting multiple mainframes using the frame link connections. Up to 4 slave mainframes can be connected to the master mainframe. The first mainframe (master) can be used to control the other slave frames. There is a delay time of 2ms between the master and first slave mainframe, and 4ms, 6ms, and 8ms to the second, third, and fourth slave mainframes, respectively. The connectors used are standard MIL 20-pin connectors. For pin arrangement see page 236.

Frame Link Connection

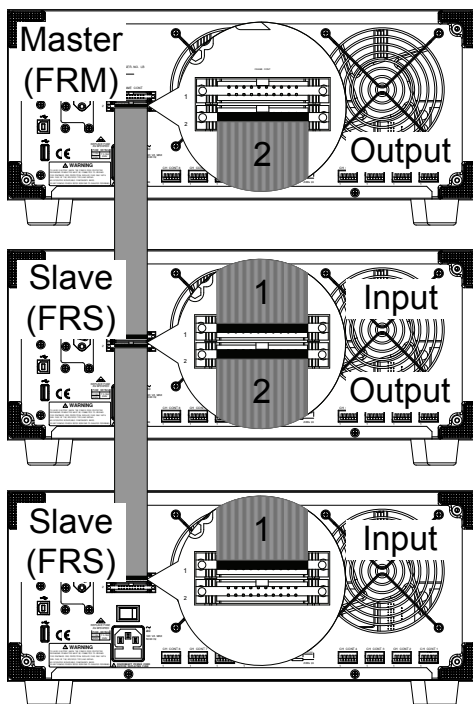

The first mainframe that is connected is the master frame; any additional frames are slave units. The ribbon cable connects to the master from connector 2, and the slave from connector 1. Each successive slave unit is connected in a cascading manner the same way.

Ensure the Mainframes are turned off before connecting the ribbon cables. Push the cable into the frame link connector. Ensure the arrows line up. The latches will close when the connection is complete. To remove, pull the latches out and connector will come out.

Insertion

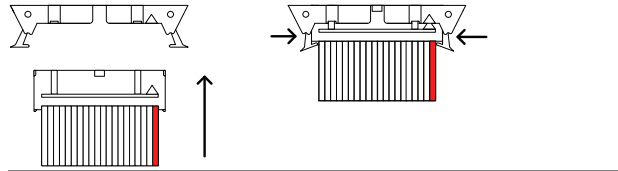

Removal

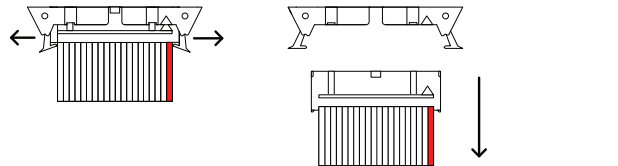

 **WARNING**

Ensure all the mainframes are off and disconnected from mains power before connecting.

Channel Control Connection

Background

The Channel Control connectors are located on the rear panel of each mainframe. There are two channel control connectors for each load slot, one for each channel, if applicable. The channel control connector is used to externally:

- Turn on/off loads.
- Supply a reference voltage.
- Monitor the load input.

For further details on channel control and the interface see pages 85, 235.

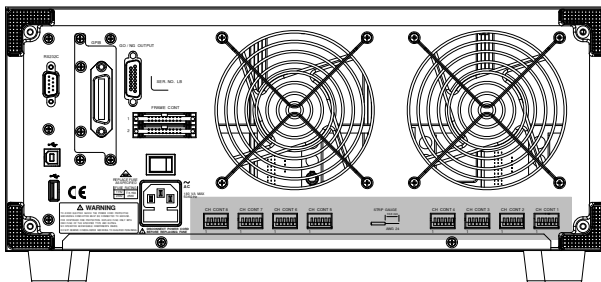

The Channel Control input/output pin layout is shown below.

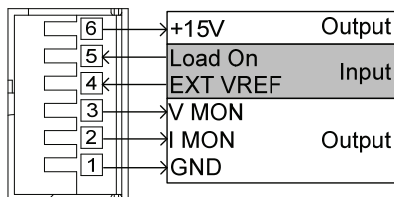

External Voltage Connection The external voltage reference input must be between 0~10V.

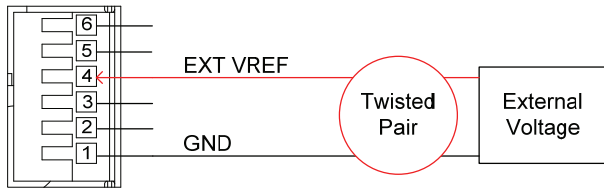

Ensure the external voltage reference is stable and has low noise. The External Voltage should be no more than 10V.

No more than 12 volts may be used as an external voltage. More than 12 volts may damage the load generator.

Load on connection

To turn a load on, an active low voltage (0-1V) must be applied across Load On (pin 5) and GND (pin 1), similarly an active high voltage (4-5V) must be applied to turn a load off. The Load On input must be TTL.

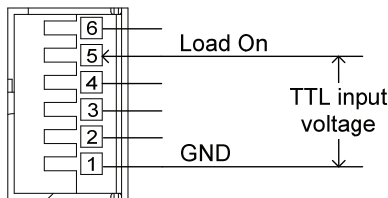

Voltage and Current Monitor Output

The Voltage Monitor Output (VMON) and Current Monitor Output (IMON) output the load input voltage and load input current as a percentage of rating current/voltage. Where 0 volts = 0% rating and 10 volts = 100% load input rating voltage or current.

The voltage monitor output is across pins 1 & 3, and the current monitor output is across pins 1 & 2. Pin 6 outputs a +15V reference voltage.

Below shows the pin configuration of the voltage and current monitor outputs.

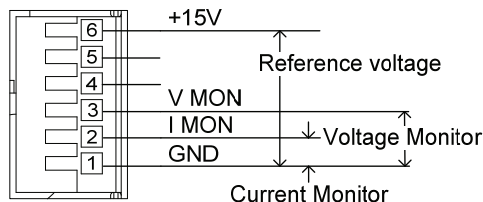

Connector Connection

The channel control connector is a screw less clamp connector. The internal clamp mechanism must be opened before a wire can be inserted. To open the internal clamp, push the button above the wire socket, to close, release the button. Ensure at least 10mm is striped from the wire. The diagram below shows the wire insertion procedure.

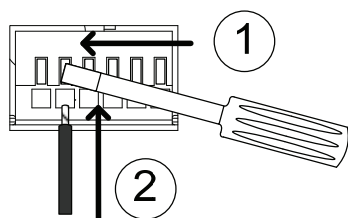

! WARNING

All connections to the channel control connector must use a 24 AWG wire gauge.

Go/NoGo Connection

Background The Go/NoGo port is a 15 socket port. Each channel has a dedicated line for a Go/NoGo output. The ports are open-collector with active low (1.1V) indicating a pass and active high (30V) as fail (an alarm). The Go/NoGo terminal is a DB-15 female.

For more details on the Go/NoGo interface see page 239.

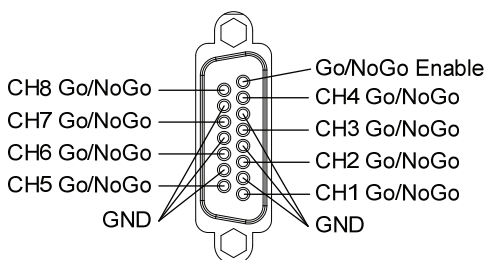

PERATING DESCRIPTION

Operating Mode Description	61
Constant Current Mode.....	61
Constant Resistance Mode.....	65
Constant Voltage Mode	68
Run Program.....	71
Sequence	74
Parallel Dynamic Loading.....	78
Configurations Description.....	79
Protection Modes.....	79
Operating Configurations.....	81
Channel Control	85
Interface and File System	89
Interface	89
File System	89
File Format	94

Operating Mode Description

There are three basic operating modes: constant current (CC), Constant Resistance (CR), and Constant Voltage (CV/CV+CC). All channels operate using any of the modes. Each mode has a number of configurable options including slew rate, levels, protection modes, Go/NoGo and extensive save options.

Constant Current Mode

Background In Constant Current Mode the load units will sink the amount of current programmed. Regardless of the voltage, the current will stay the same. There are two ranges in CC mode: High and Low. There are two main modes in CC mode: Static and Dynamic. Static mode can be used for stability tests and dynamic mode can be used to test transient load conditions.

Go/NoGo is supported for both High and Low range as well as Static and Dynamic mode.

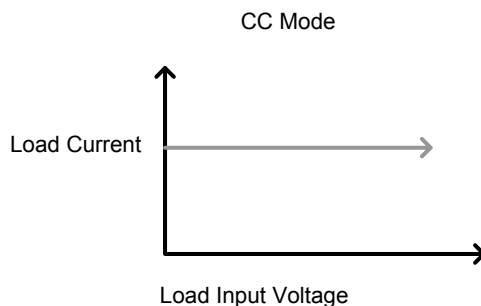

Range There are two selectable ranges for constant current mode: high and low range.

Low range has a higher resolution, but a lower range. If the current exceeds the Low Range, High range must be used.

Static Functions Static mode tests the stability of the voltage output from a power source. Single channel load modules can have two 2 current levels A (A Value) & B (B Value). A & B have the same range. Pressing the A/B key on the module load will cycle through the A and B states. Alternatively, the mainframe can select A or B Value.

Dual channel load modules only have one current level (A Value) per channel in static mode.

Static Mode:
Single Channel
Load module.

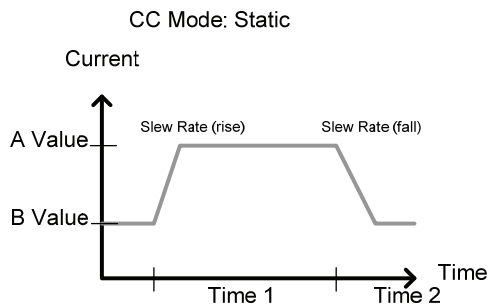

Dynamic Functions Dynamic load functions allow you to set load levels (Level1, Level2), load time (Timer1, Timer2), and the slew rate (rising, falling). Depending on the settings, the load will switch automatically between levels 1 and 2.

Dynamic loading can be used for charge discharge cycle testing etc.

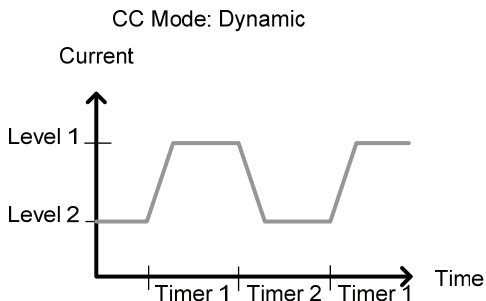

Slew rate

The slew rate is the rate at which the current will increase to a set level. There are two slew rates: rising slew rate & falling slew rate. In CC mode the slew rate is defined as A/uS.

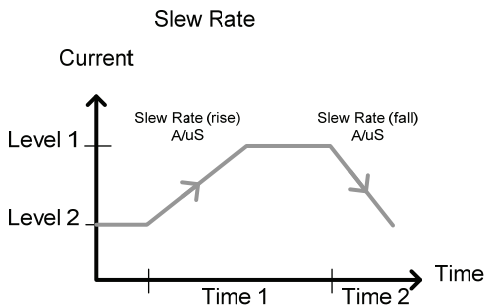

As can be seen above, the rising and falling slew rate need not be the same.

Go/NoGo

Using Go/NoGo, the Center, High and Low voltage limits can be set for both Static and Dynamic modes. A delay time of up to 1 second can also be set.

CC Mode: Static:Go/NoGo

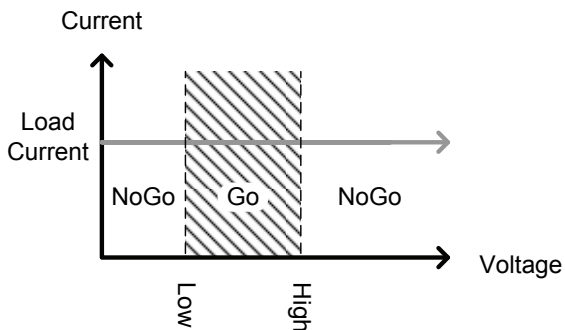

CC Mode: Dynamic:Go/NoGo

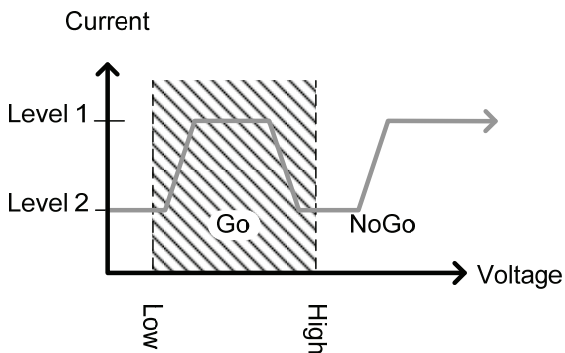

GO is specified as between the Low and High Go/NoGo limits. NoGo is specified as outside the Go/NoGo limits.

Constant Resistance Mode

Background In Constant Resistance Mode the load units will linearly sink current and voltage to match a set resistance. CR mode has two different values (single load modules), two different ranges and rising and falling slew rates. Like CC mode, Constant resistance mode supports both dynamic and static loads. As with the other modes, Go/NoGo is supported.

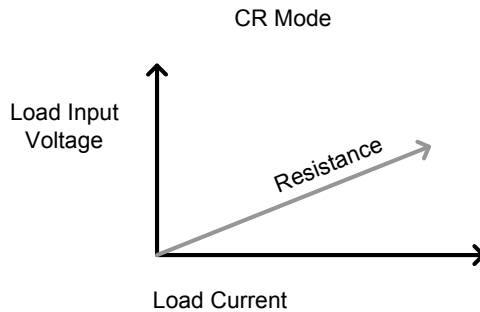

Resistance Range There are two ranges: High and Low. The Low range is used for low voltage ranges, whilst the High range uses high voltage ranges. The current range always remains in High range, regardless of the selected voltage range.

Static Functions A/B range For static mode, single channel load modules have two resistance levels, A & B Value. The A/B key can be used to switch between these resistance levels. Dual channel load modules only have one resistance level, A Value.

Single Load Module

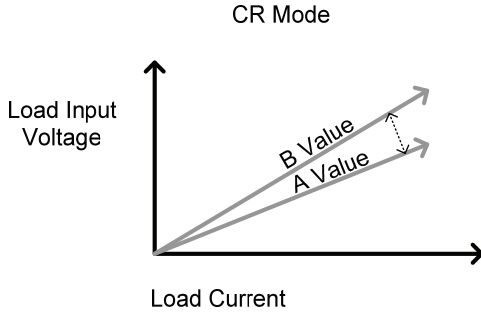

Dynamic Functions

CR mode supports Dynamic loading. Dynamic load has two resistance levels (Level 1&2), and two timers (Timer 1&2) to switch between the resistance levels. Rising and falling slew rates can be set to determine the speed at which the load generator switches between load levels.

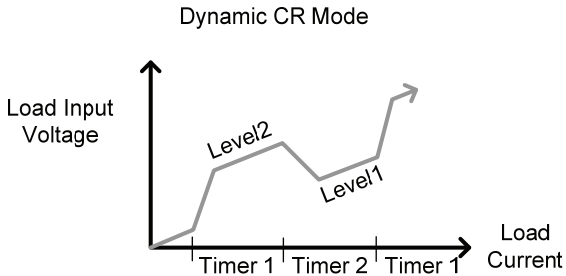

Slew Rate

The rising and falling slew rate (A/uS) determines the speed at which the load levels change from A to B Value (Static mode) or from Level1 to 2 (Dynamic mode) and vice versa.

Go/NoGo

Go/NoGo is also supported. Center, High and Low limits can be set as either percentages or voltage values. A delay time of up to 1 second can also be set.

CR Mode: GO/NOGO

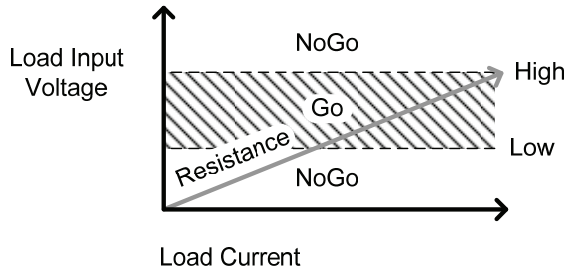

Constant Voltage Mode

Background In Constant Voltage Mode the load units will sink current whilst keeping the voltage constant.

Single channel load modules support 2 values (A Value, B Value) and have an adjustable cut-off current limit. Dual channel load modules only have A value.

Response speed can also be set to fast (Fast) or slow (Slow). The response speed relates to the slew rate of the current response.

Constant voltage mode only operates in high range.

Go/NoGo functionality is also supported either as a percentage or as a current value.

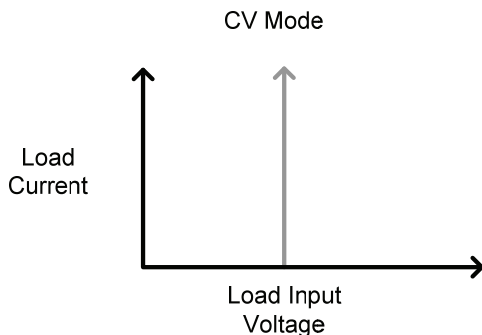

Voltage levels Two voltage levels can be set: A & B (single channel load module).

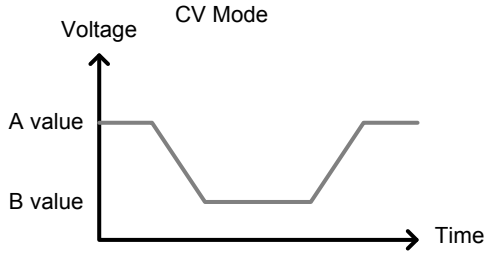

CV + CC

When using CV mode, a current limit can be set for CV + CC mode.

When the voltage input is greater than A Value (load voltage) then the channel will operate in CV mode if the input current is less than the current limit. When the input current exceeds the current limit, the channel will operate in CC mode.

When the voltage input is less than A Value (load voltage) current stops flowing.

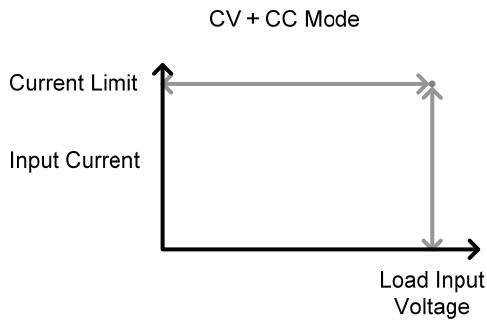

Response Speed Response speed can be set to fast or slow. Fast response and slow response is determined by the load module specifications. Slow response speeds are suitable for large loads as quick current changes will induce induction which can cause large voltage drops. The PEL series will try to rectify any voltage drops. However if voltage drops are too large, they may cause the load generator to go into oscillation. Large voltage drops caused by line voltage induction may damage the machine.

Range	Fast	Slow
	1kHz	100Hz

Go/NoGo Go/NoGo testing can be with either current (Ampere) values (High, Low) or percentage values (Center, High %, Low %). A delay time of up to 1 second can also be set.

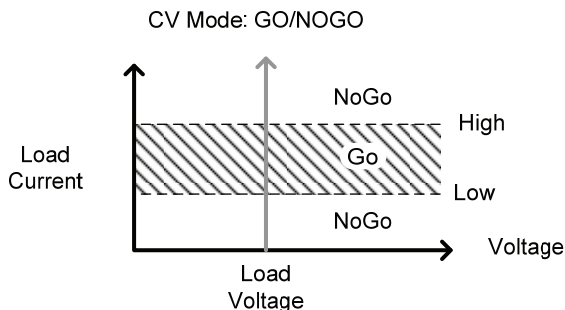

Run Program

Background The Program function on the PEL-2000 series supports a total of 12 different programs at any one time with 10 sequences to each program. Up to 12 programs can be chained together. The Program function is able to create a number of Go/NoGo tests.

Program Sequence A program sequence is simply a single load test. A program is a battery of each of these tests run in succession. Each sequence loads the settings for each channel from Memory Data (Memory MXXX). The Memory Data stores settings such as the operating mode and range for each channel. Each sequence loads all channels at the same time, unless programmed otherwise. Sequences for each channel run synchronously.

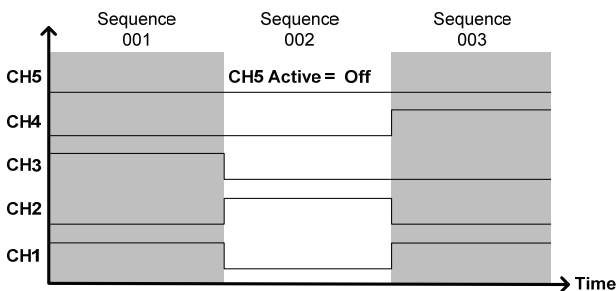

Each Sequence has a number of configuration options that apply to all the channels equally.

Sequence Item	Parameter Range
Memory	M001~M120
Run	Auto – Skip – Manual
On-Time	0.1 ~ 60.0
Off-Time	Off – 0.1 ~ 60.0
Short-time	Off – 0.1 ~ On-time

P/F-Time	Off – 0.1 ~ (On-time+Off-time)-0.1
Short Channel	CH1 ~ CH8

Program Sequences are run sequentially to create a Program. There are 10 Sequences in each Program.

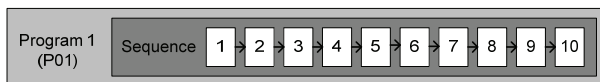

If less than 10 Sequences are desired for a Program, any additional Sequences can be skipped (not run).

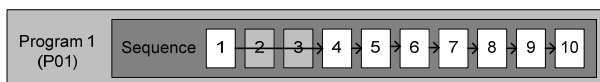

Sequence 2 & 3 are skipped.

Program Chain Any of the 12 programs can be chained together to create a Program Chain. Unlike Program Sequences, Program Chains need not be run sequentially in numerical order. Any program can be chained to any program. It is possible to chain programs into an infinite loop to continue a program indefinitely.



Above, a program chain running sequences out-of-order.

Go/NoGo Results If Go/NoGo limits have been configured, the Pass/Fail results for each channel will be displayed for all the sequences and programs.

03/02/09
10 : 30 PROG

Channel

Program no.	P	S	1	2
Sequence no.	1	1	G	N
Channel	1	2	G	N
	1	3	G	N
	1	4	G	G

Go/NoGo

Exit

Sequence

Background

The Sequence function is used to create high resolution load simulations. Each Sequence can be configured to create a unique load profile to accurately simulate loads in real time. Sequences are only applicable for CC (Static) and CR (Static) modes.



Note: Sequences are not to be confused with the sequences used to create a program. They are not the same and cannot be used interchangeably. Sequences (SEQ memory) cannot be used in Programs and Programs cannot load Sequences.

Load Profiling

The Sequence function is able to simulate a load to a high resolution. Each channel is able to change its load sink within 100us per point independently. When used in parallel, multiple loads can be sunk concurrently to simulate the loads placed on multiple output power sources.

The diagram below shows the load profile of a DUT at start-up.

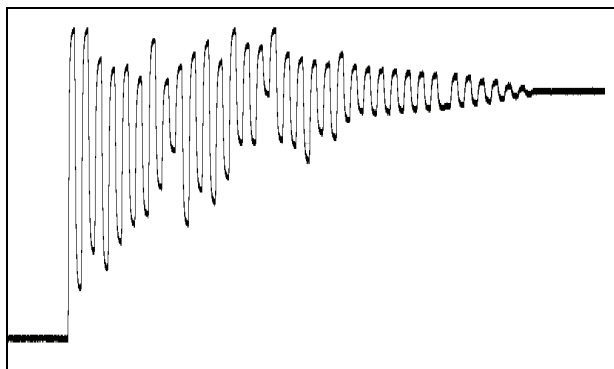

Points

Up to 120 points can be used with each Sequence. Each point can have a different duration, slew rate and value.

A new point can be inserted or deleted at any stage of a Sequence. Any new points that are inserted will have a value averaged from its neighbors as default.

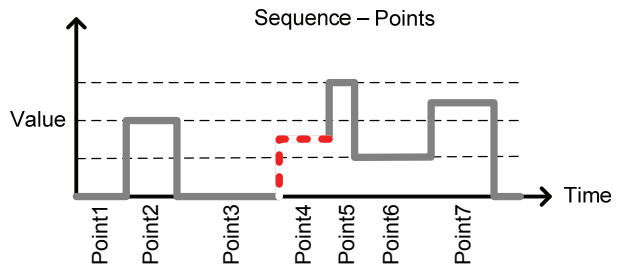

A new point is inserted after Point 3.

Loop

Sequences can be programmed to loop a number of times starting from any point in the sequence.

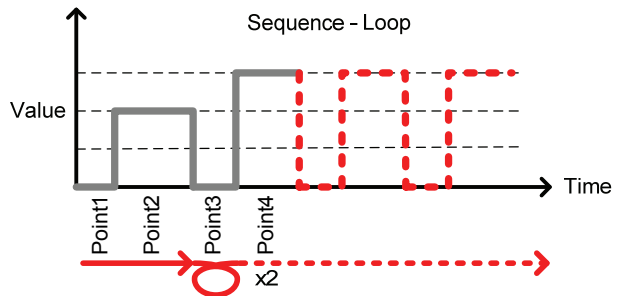

From Point3 the sequence is looped two times.

On end load

If more than one Sequence is programmed on the mainframe, the On End Load function allows a Sequence to configure its load on or off at the end of its sequence until the last sequence ends. After the last sequence ends, all loads are turned off. This function is ineffective if only one Sequence is active. This is as the On End Load time and the time of the last sequence will be the same.

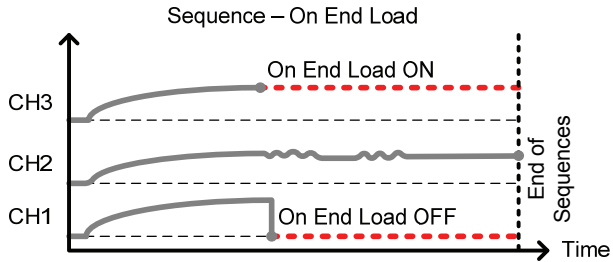

Trig Out

The Trigger Out function allows a trigger sequence signal to be output from a channel via PIN 4 on Frame Link connector 1 when using Sequences. The Trig Out function is used from the Channel Duration menu.

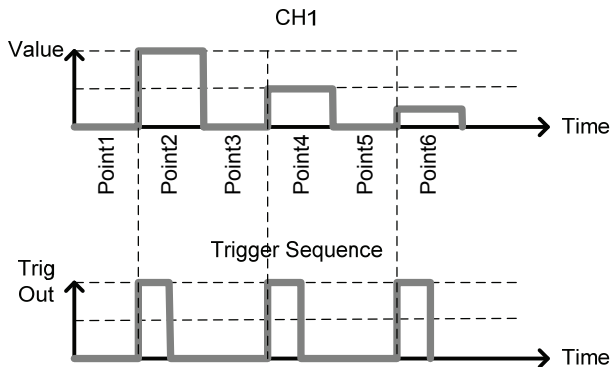

As can be seen above, a trigger sequence signal is output for every rising edge point.

Channel Duration Time Setting The Channel Duration Time Setting feature allows the point time duration of one Sequence to be imported by another Sequence. If the receiving sequence doesn't have enough points, more will be created (without values).

For example, the sequences for CH1 and CH2 are shown below. CH1 has a total of 6 points with long durations, whilst CH2 has only 2 points, looped 5 times. The points from CH2 are also significantly shorter in duration.

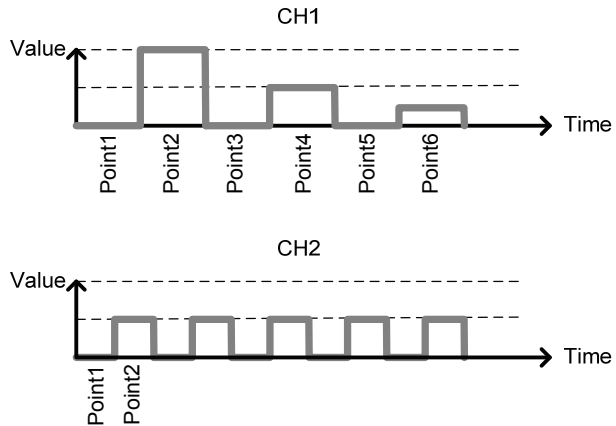

Below shows the resulting sequence when CH1 imports CH2. CH1 imports the duration time settings and number of points from CH2, but not the value data.

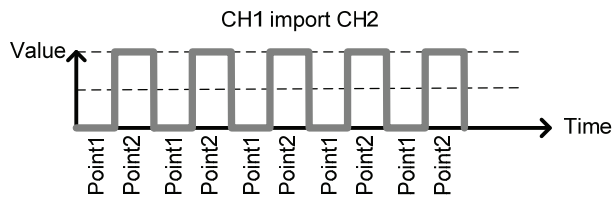

Parallel Dynamic Loading

Background

The PEL-2000 series of DC electronic loads support parallel dynamic loading. This simply means that when the load modules of a mainframe are connected in parallel and set to dynamic mode, they can perform dynamic tests synchronously following the same clock. Under dynamic mode, load current or resistance is pulsed between two preset levels. When used in parallel, higher powered outputs can be tested. This ability gives the PEL-2000 series the flexibility to perform dynamic tests over a wide range of power outputs.

For connection details see the Parallel Load Connections section on page 52.

The diagram below shows how two load modules are able to sink a higher load when used in parallel under dynamic mode.

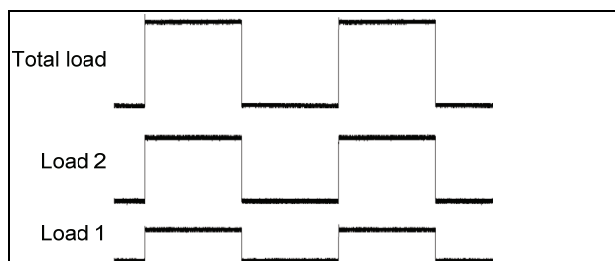

Configurations Description

There are a number of different configurations for the PEL series including protection modes, operating configurations, and file system configurations. The Configuration Description section describes what the different configurations are used for and how they can be relevant to different operations.

Protection Modes

Background The PEL 2000 series include a number of protection modes: Over Current Protection, Over Voltage Protection and Over Power Protection.

The protection modes are useful to protect both the load modules and the DUT(s). A buzzer can be set to notify when a protection setting has been tripped. When a protection feature is activated and has been tripped then the load unit will display an alarm. The Mainframe will also display an alarm. When an alarm has been tripped the load will stop sinking current/voltage. There are three Over load protection settings: ON, OFF and Clear.

03/02/09		10 : 30		Alarm	
OCP Level		5.10 A		CH1 CC Dyna High Conf	
OCP Setting		OFF			
OVP Level		81.6 V			
OVP Setting		ON			
OPP Level		30.6 W			
OPP Setting		OFF			
Protection	Other	Go-NoGo		Previous Menu	

Over Current Protection

When a load unit is operating in CR or CV mode, the unit may need over current protection to prevent excessive current being sunk. Over current protection stops the load from sinking more current than its recommended limit which can cause damage to the unit.

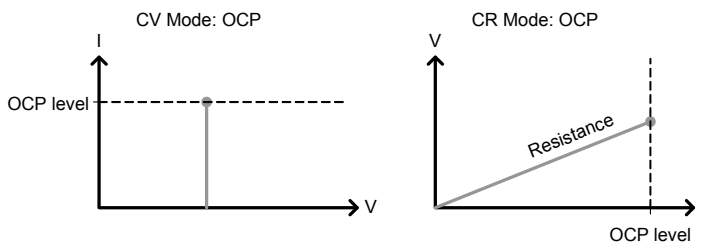

Over Voltage Protection

Over voltage protection is used to limit the amount of voltage sunk. If the OVP trips, the PEL series load will stop sinking voltage.

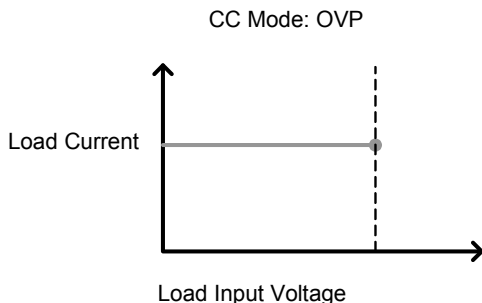

Over Power Protection

Over power protection is used when the power range exceeds the specifications of the load. When OPP is tripped power will cease to be sunk.

Reverse voltage Protection Reverse voltage protection prevents reverse voltage damage to the PEL-2000 series up to the specified rating. When Reverse voltage protection has been tripped an alarm tone will sound until the reverse voltage is removed.

For more details please see the specifications.

Under voltage Protection Under voltage protection will turn off the load when the voltage drops below a set limit.

Operating Configurations

Background There are number of operating configuration settings. Configuration settings are for the following:

CC Vrange, Von Voltage, Von Latch, Short Key, CH Cont, Independent load sync, D-time and Step resolution settings.

CC Vrange CC Vrange (page 165) is used to set the voltage range as High or Low for CC mode. CC voltage range is dependent on the load module specifications.

Von Voltage

Von Voltage is the voltage limit at which the load will start to sink current. There are two operation modes for Von Voltage: Von latched:ON and Von latched:OFF.

Latched: ON will sink current when Von has been tripped, and will continue to sink current even if the voltage drops below the Von Voltage.

Von Latched: OFF will sink current when Von has been tripped, but will stop sinking current when the voltage drops below the Von Voltage setting.

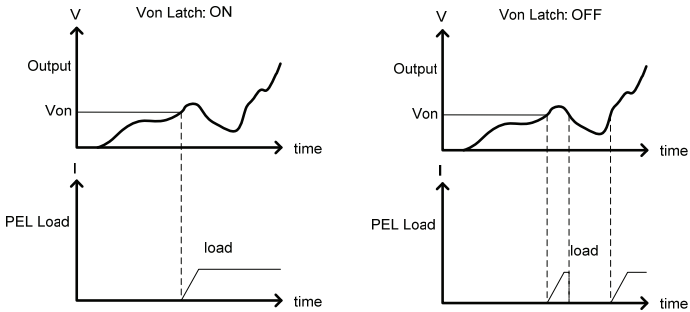

As can be seen in the diagram below, when Von-Latch is set to off, the load module will start to sink current when the Von-voltage limit has been tripped. It will stop sinking current when the output drops below the Von voltage limit.

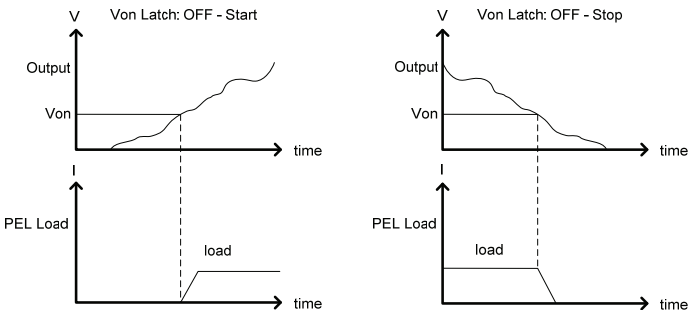

Short When short mode is on, the load unit can simulate a short circuit.

Shorting can be individually set for each channel when programming sequences.

To initiate a short circuit manually, the short key is used. It can be used at any time during an operation. It will not affect the settings. After a short circuit has finished, the load unit will resume the previous operation.

The short key can be set to toggle or hold. When pressed in toggle mode, shorts are toggled on and off. When pressed in hold mode, the key needs to be held to short the load.



A short circuit may trip a protection mode if too much current is sunk.

CH CONT Channel Control. When Channel control is activated (External) it can be used to monitor the voltage and current output of the load as well as turn loads on or off remotely from the Channel Control (CH CONT) connectors located on the rear panel.

For more information about channel control, see external voltage control on page 85.

Independent The Independent setting will allow the load modules to be controlled independently from the mainframe.

Load D-Time Load Delay time is used to delay activating a load (up to 10 seconds) after the load key has been pressed. However the Load D-Time setting will only work for loads that are initiated manually or when the PEL series mainframe is configured to Auto load (page 182) at run time.

Step Resolution Each channel voltage, current and resistance setting can have the step resolution configured.

For example if the step resolution for CCH (CC high range) is .5 A, then the resolution can be incremented in .5A steps;

$$8.0 \leftarrow \rightarrow 8.5 \leftarrow \rightarrow 9.0 \leftarrow \rightarrow 9.5$$

The step resolution parameters apply to the following:

- CCH Step – CC high range
- CCL Step – CC low range
- CRH Step – CR high range
- CRL Step – CR low range
- CV Step – CV high range

Step Resolution Range The step resolution range is dependent on the load module and the range:

Max resolution: channel range/4000

Min resolution: channel range/2

Channel Control

Background External channel control is used with the Channel Control connectors. Each channel control connector can activate each load, monitor voltage and current and has an external voltage reference input. The voltage and current monitors output 0~100% of the rated current/voltage as a voltage of 0~10V.

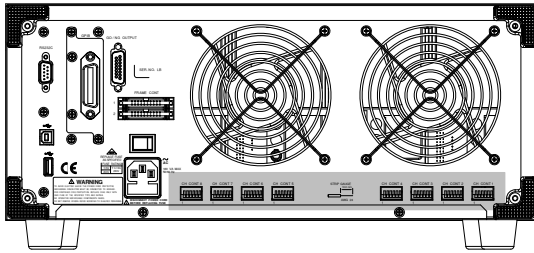

External Voltage Reference A voltage reference of 0-10V is used to represent 0-100% of the rating voltage/current of a load module. As seen below the external voltage reference and the rating voltage/current have a linear relationship. By varying the reference voltage between 0~10V the voltage/current setting will be changed accordingly.

External Voltage Control

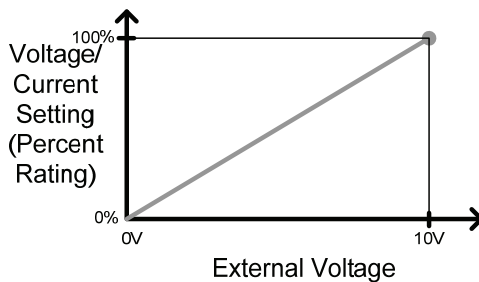

To determine the Percent Rating (voltage or current load input), use the following formula;

$$\text{Load Input} = \frac{\text{External Voltage}}{10(V)} \times \text{Rating Vor A}$$

Where "Rating Vor A" is the rating voltage/current of the load module.

Current Monitor The load current input can be externally monitored using the IMON pin of a channel control connector. The IMON pin outputs a voltage of 0~10V to represent the input current of as percentage (0~100%) of rating current.

Current Monitor

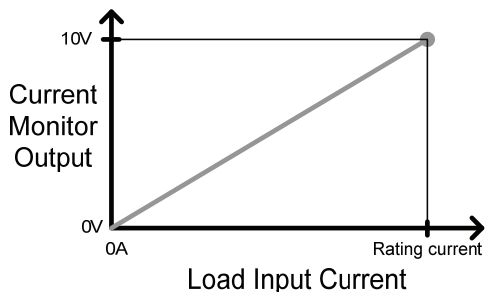

To determine the Current Monitor Output (IMON) , use the following formula;

$$\text{IMON} = \frac{\text{Load input current}}{\text{Rating A}} \times 10V$$

Where "Rating A" is the rating current of the load module.

Voltage Monitor The input voltage, like the load input current can be externally monitored with the channel control connectors. The VMON pin of the channel control connector outputs a voltage of 0~10V to represent the load input voltage as a percentage (0~100%) of the rating voltage.

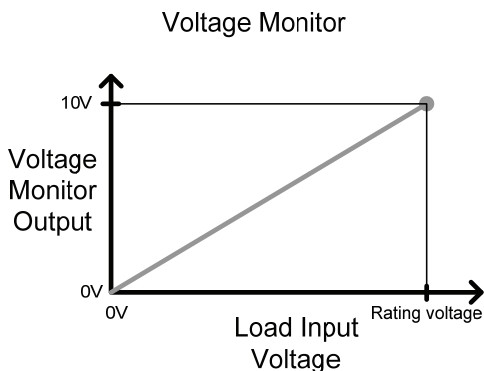

To determine the Voltage Monitor Output (VMON) , use the following formula;

$$VMON = \frac{\text{Load input voltage}}{\text{Rating } V} \times 10V$$

Where “Rating V” is the rating voltage of the load module.

Turning on the Load A load is turned on when Load On input is set to On (active low). A load is turned off when the Load On input is set to Off (active high).

When a load is turned on from the channel control interface, the load can be turned off from the mainframe, local module and via remote control. However the opposite is not true; when a load is turned off using the channel control interface, the load cannot be turned on via the mainframe, local module or via remote control.

For connections and configurations, see pages 56 and 235 respectively.

Interface and File System

Interface

Background The PEL series support RS232, GPIB and USB remote frame control. Only one type of connection is supported at any one time. For more information on remote control please see the GW Instek website at www.gwinstek.com or see your local distributor about the PEL-2000 programming manual.

For connection options and configurations see the options below.

RS-232 configuration.	Page 196
RS-232 pin connection.	Page 233
GPIB configuration.	Page 198
GPIB pin configuration.	Page 234
USB configuration.	Page 199

File System

Background The PEL series is able to save and recall a number of different data types for each channel:
Presets
Memory
Setup
SEQ (Sequence)

All data types can be saved and recalled to internal memory or saved to a USB flash drive. Each channel has its own dedicated memory for each

data type. Thus files are saved/recalled for each channel and each data type.

Preset Data Preset data can be saved into 10 memory slots for each channel. Preset data contains the mode, range, CV response speed and Go/NoGo settings.

Internal Format P0~P9

External Format 20X0X_XX.P

Preset Contents Preset data contains the following data;

- | | | |
|---------|---|---|
| CHAN | <ul style="list-style-type: none"> • Mode • Range | <ul style="list-style-type: none"> • Static/Dynamic • CV response speed |
| Go/NoGo | <ul style="list-style-type: none"> • SPEC Test • High • Center | <ul style="list-style-type: none"> • Entry Mode • Low |

Memory Data Each channel can save up to 120 different Memory data types (M001~M120) into internal memory. Memory data contains general channel settings and is used when programming sequences. Memory data can be stored both internally and externally to USB. Preset data and Memory data store the same contents.

Internal Format M001~M120

External Format 20X0X_XX.M

Memory Contents Memory data contains the following data;

- | | | |
|---------|---|---|
| CHAN | <ul style="list-style-type: none"> • Mode • Range | <ul style="list-style-type: none"> • Static/Dynamic • CV response speed |
| Go/NoGo | <ul style="list-style-type: none"> • SPEC Test • High • Center | <ul style="list-style-type: none"> • Entry Mode • Low |

SEQ Data	SEQ data contains Sequence data. SEQ data can only be saved to and from USB. SEQ refers to Sequence data, not Program sequences.						
	Internal Format N/A (Internal buffer)						
	External Format 20X0X_XX.A						
SEQ Contents	SEQ data contains the following data;						
	<table border="0"> <tr> <td data-bbox="369 470 504 606">Seq.Edit</td> <td data-bbox="504 470 728 606"> <ul style="list-style-type: none"> • No. (Points) • Slewrate f • Duration time </td> <td data-bbox="728 470 993 606"> <ul style="list-style-type: none"> • Value • Slewrate \downarrow </td> </tr> <tr> <td data-bbox="369 606 504 686">Loop</td> <td data-bbox="504 606 728 686"> <ul style="list-style-type: none"> • Repeat • On End Load </td> <td data-bbox="728 606 993 686"> <ul style="list-style-type: none"> • Start of Loop • CC Vrange </td> </tr> </table>	Seq.Edit	<ul style="list-style-type: none"> • No. (Points) • Slewrate f • Duration time 	<ul style="list-style-type: none"> • Value • Slewrate \downarrow 	Loop	<ul style="list-style-type: none"> • Repeat • On End Load 	<ul style="list-style-type: none"> • Start of Loop • CC Vrange
Seq.Edit	<ul style="list-style-type: none"> • No. (Points) • Slewrate f • Duration time 	<ul style="list-style-type: none"> • Value • Slewrate \downarrow 					
Loop	<ul style="list-style-type: none"> • Repeat • On End Load 	<ul style="list-style-type: none"> • Start of Loop • CC Vrange 					
Setup Data	Setup data can be saved to 4 internal memory slots. Setup data contains Memory data, Program Sequence, Chain data, configuration settings and operation settings for every channel. Setup data can be saved to Internal memory or to USB.						
	Internal Format Setup Memory 1~4						
	External Format 200X0_XX.S						
Setup Contents	Setup data contains the following data;						
	<table border="0"> <tr> <td data-bbox="369 1061 504 1308">Program</td> <td data-bbox="504 1061 728 1308"> <ul style="list-style-type: none"> • PROG • Memory • On-Time • P/F-Time • Short Channel </td> <td data-bbox="728 1061 993 1308"> <ul style="list-style-type: none"> • SEQ (program sequence no.) • Run • Off-Time • Short-Time </td> </tr> <tr> <td data-bbox="369 1308 504 1401">Chain</td> <td data-bbox="504 1308 728 1401"> <ul style="list-style-type: none"> • Start </td> <td data-bbox="728 1308 993 1401"> <ul style="list-style-type: none"> • Program Sequence (P01~P12) </td> </tr> </table>	Program	<ul style="list-style-type: none"> • PROG • Memory • On-Time • P/F-Time • Short Channel 	<ul style="list-style-type: none"> • SEQ (program sequence no.) • Run • Off-Time • Short-Time 	Chain	<ul style="list-style-type: none"> • Start 	<ul style="list-style-type: none"> • Program Sequence (P01~P12)
Program	<ul style="list-style-type: none"> • PROG • Memory • On-Time • P/F-Time • Short Channel 	<ul style="list-style-type: none"> • SEQ (program sequence no.) • Run • Off-Time • Short-Time 					
Chain	<ul style="list-style-type: none"> • Start 	<ul style="list-style-type: none"> • Program Sequence (P01~P12) 					

- | | | |
|---------|----------------------------|---------------------|
| Run | • Active Channel (CH01~08) | |
| CHAN | • Mode | • Static/Dynamic |
| | • Range | • CV response speed |
| Go/NoGo | • SPEC Test | • Entry Mode |
| | • High | • Low |
| | • Center | |

Save: Internal memory

When saving data to internal memory, either the current channel or all the channel data can be saved. Not all data types can save the current channel or all the channel data.

Data Type	Current Ch	All Ch
Preset	•	•
Memory	•	—
SEQ	• (single save)	•
Setup	—	•

Save: External memory

Only SEQ, Memory and Preset data can be saved for a single channel to USB. All four data types (SEQ, Memory, Setup, Preset) can save all channels to USB.

Data Type	Current Ch	All Ch
Preset	•	•
Memory	•	•
SEQ	•	•
Setup	—	•

Save/Recall USB In order to save data from a single channel to USB, data must first be saved to the internal memory. After data is saved to internal memory, all the files can be saved to USB.

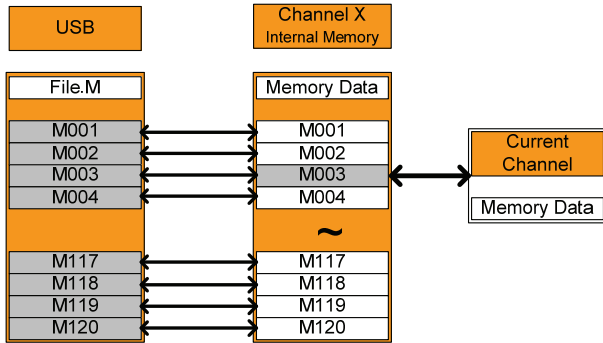

To recall saved files, the reverse is also true. Files must be recalled from the USB flash drive to internal memory. Then from internal memory the data can be recalled to each channel*.

*Excluding SEQ data.

Save/Recall All The SEQ, Preset, Memory or Setup data can be saved from every channel into USB. SEQ, Preset and Memory data is saved into a directory (ALL0000-ALL0099) with a file for each channel, whilst Setup data is saved in a single file.

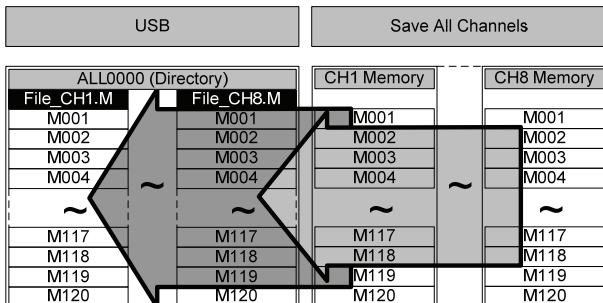

To recall saved files, the reverse is not true. Files must be recalled to each channel separately.

File Format

Single Channel

Filename format

Memory data
Preset data
SEQ data

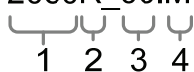
2030R_00.M

1: PEL series Load module type:

2020 = PEL-2020

2030 = PEL-2030

2040 = PEL-2040

2: Channel

R = Right

L = Left

0 = Single channel or not used

3: Save file number:

0 ~99

Incremented after each consecutive save.

4: File extension

M = Memory data

P = Preset data

A= SEQ data

All Channel

Directory Format

ALL_0000

- 1: All Channel common directory name
- 2: Directory number:
0000 ~ 0099

All Channel

File Format

Memory data
 Preset data
 SEQ data
 Setup Data

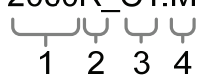
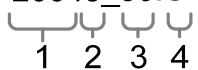
2030R_C1.M

 20040_00.S

- 1: PEL series Load module type:
 P020 = 2020
 P030 = 2030
 P040 = 2040
- 2: Channel
 R = Right
 L = Left
 0 = Single channel
- 3: Channel number:
 C1 = CH1
 C2 = CH2
 Etc.
 00 = All channels (Setup data)
- 4: File extension
 M = Memory data
 P = Preset data
 A = SEQ data
 S = Setup data

TUTORIALS

(Step by Step Operations)

Local loads.....	97
Single Channel Load.....	99
Programming	101
Sequences.....	103
Frame Link	104
Channel Control	106
General Configuration Options.....	108

Local loads

Local mode operation is useful to quickly test loads using the load module control panel rather than the mainframe control panel. Local load modules can be configured to operate independently to the mainframe. This can be useful when settings need to remain unchanged on the mainframe. Note however that the local modules cannot change the modes (CC, CV, CR), only the values.

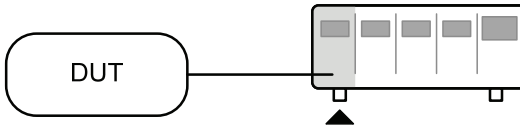

Step	Description	Details
1. Setup	Ensure the channel load is set up as desired.	Pages 35, 43
2. Channel selection	Ensure the correct channel or Value (A/B) is selected by using the R/L or A/B key.	Page 113
3. Measurement Mode selection	If in CC or CR mode, Static or Dynamic mode can be selected.	CC Pages 114, 126 CR Pages 129, 132
4. Run the Load	Press the LOAD key to start/end loading the device under test.	Page 115

Optional

5. Short configuration	Configure the SHORT key to hold/toggle short circuit configuration.	Page 116
6. Display	To change the display output, use the DISPLAY key.	Page 117
7. Shorting the load	To short the load, use the SHORT key when the load is on.	Page 116
8. Independent load	The local load modules can be set to independent load.	Page 171

9. Independent control	Load module Selector knobs can be configured to be independent to the mainframe.	Page 188
10. Configure Slave Knob Settings	Display Measured or Set Values with the selector knob.	Page 192

Single Channel Load

Single channel loads are used to manually test a DUT quickly or to configure channel settings for Program Sequences using the mainframe panel.

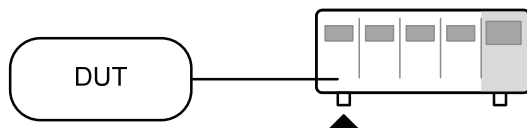

Step	Description	Details
1. Setup	Choose the appropriate load module and make sure it is installed.	Page 35
2. Connection	Connect the terminals to the DUT.	Page 43
3. Channel selection	Select the load channel on the mainframe.	Page 119
4. Measurement mode selection	Select measurement mode (CC, CV, CR).	CC Page 122 CV Page 134 CR Page 128
5. Range selection	Set the range to high or low (CC, CR mode).	CC Page 123 CR Page 128
6. Mode selection	Choose Static or Dynamic mode (CC & CR mode only).	CC Pages 123, 126 CR Pages 129, 132
7. Dynamic levels	Set the dynamic levels, slew rate and timers. Applicable to CC & CR mode only.	CC Page 124 CR Page 130
8. Static Values (CC, CV,CR)	Set the A(B) Value, slew rate (CC, CR) and current limit (CV)	CC Page 126 CR Page 132 CV Page 135

9. Go/NoGo Set the Go/NoGo configurations, Page 177
if applicable.

10. Protection Modes Configure the protection modes. Page 162

11. Run Activate the load by pressing the load key.



Optional

12. Configuration There are number of configurations that apply to all channels. For details see the Configuration Tutorial. Page 108

Programming

When creating a Program Sequence or Chain, all channels are used at the same time unless programmed otherwise. Program Sequences use the channel settings stored from Memory Data. Program sequences are primarily used to perform a battery of pass/fail tests on DUTs.

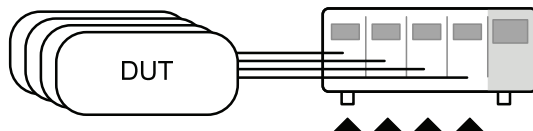

Step	Description	Details
1. Setup	Choose the appropriate load module(s).	Page 35
2. Connection	Connect the terminals to the DUT.	Page 43
3. Channel selection	Select the load channel(s) on the mainframe.	Page 119
4. Channel setup	See the “Single channel load” tutorial to configure a single channel. Do not activate the load.	Page 99
5. Save channel	Save the configured channel.	Page 201
6. Multiple channels	If multiple channels need to be configured, follow steps 1-5 for any remaining channels.	
7. Program menu	Enter the Program menu.	Page 138
8. Configure the sequence	Configure the first program.	
9. Save sequences	Save the Program in the FUNC →Program menu.	
10. Program Chains	If required, Program chains can be created.	Page 143
11. Save Program	Save the chain in the Chain menu.	

12. Save Setup	Save everything to the internal Setup memory.	Page 206
13. Run	Run the Program Sequence/Chain.	Page 145

Sequences

Sequences are used to accurately simulate loads. As each Sequence is independent, Sequences are ideally suited to test multiple output power sources.

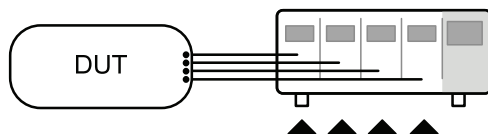

Step	Description	Details
1. Setup	Choose the appropriate load module(s).	Page 35
2. Connection	Connect the terminals to the DUT.	Page 43
3. Channel selection	Select a load channel with the mainframe.	Page 119
4. Channel setup	Create a sequence.	Page 151
5. Sequence loop	Create a sequence loop if necessary.	Page 153
6. Multiple channels	If multiple channels need to be configured, follow steps 1-5 for any remaining channels.	
7. Channel Duration menu	Edit the sequence channel duration information. Ensure that the channels containing Sequences are not set to OFF.	Page 155
8. Run	Run the Sequence(s)	Page 157

Frame Link

Frame link connections are used connect up to four slave main frames to a master main frame. When using frame link connections it is possible to perform a number of operations in parallel under the control of the master unit.

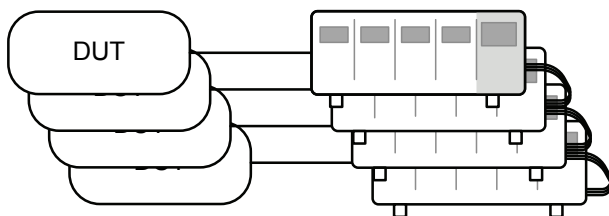

Step	Description	Details
1. Setup	Connect the mainframes together.	Page 54
2. Configure	Configure the Frame CONT to ON for all mainframes.	Page 187

03/02/09
10 : 30

FRM

At first both the master and slaves are independent. FRM (Frame Master) can be seen on the top panel of the each mainframe. When a mainframe is connected as a slave unit, the FRM icon will change to FRS (Frame Slave). The front panel keys are disabled on slave units when in slave mode (FRS).

Slave mode **FRM** → **FRS**

Master/Independent **FRM**

3. Program	See the tutorial sections for programming or channel configuration.	Pages 99, 101
------------	---	---------------

- 4. Run Run the loads. To run the loads, press the LOAD key on the master mainframe. To stop, press again. When the LOAD key is pressed all loads will be active.



Options

- 5. Load Preset memory Load preset memory on the mainframe and all frame-linked slaves. Page 230

- 6. Load Setup Memory Load setup memory on the mainframe and all frame-linked slaves Page 229

- 7. Set slave to independent Press shift + CHAN on the slave unit to enable local control on a slave unit.

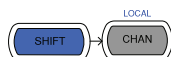

FRS → **FRM**



Note

When a load is run or memory is recalled from the master mainframe, the slave unit will return to mainframe control.

Channel Control

The Channel Control connectors on the rear panel can be used to control and monitor the status of up to 8 channels. For more information on channel control, see page 85.

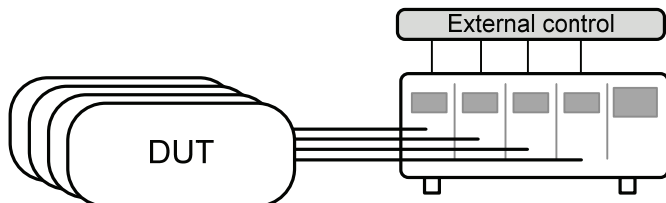

Step	Description	Details
1. Setup	Ensure the load and PEL series mainframe is turned off.	
2.	Choose the appropriate load module(s).	Page 35
3. Connection	Connect the terminals to the DUT.	Page 43
4.	Connect the channel control connectors on the rear panel.	Page 56 & 235
5.	Turn on the PEL series mainframe and DUT (load).	
6. Configure	Select the Mode* and Range* via the front panel.	CC Pages 122, 123 CV Page 134
7.	Activate channel control for each channel that will be used for external control, i.e., set CH CONT to External.	Page 170
8. Run	Run the load. Turn the load on by either outputting an active low signal to the appropriate channel control connector or use the mainframe LOAD key*.	Page 56 & 85

9. Monitor Use IMON and VMON to monitor the current and voltage of load outputs. Page 85

10. End To turn the load off, output an active high signal to the channel control connector, or press the LOAD key on the load module or mainframe**.

* Mode and Range cannot be configured via the Channel Control (CH CONT) interface. Mode and Range can only be configured via the front panel.

** The LOAD key cannot always be used to turn on/off the load. See page 85 for details.

General Configuration Options

There are number of different options for each channel. The different options are described below.

Options	Description	Details
1. CC Vrange	Configure the CC Voltage range from high or low.	Page 165
2. Von Voltage	Configure the Von Voltage settings.	Page 167
3. Short key	Configure the short key to toggle or hold.	Page 168
4. CH CONT	Turn channel control on/off	Page 170
5. Independent load	Turn the load module control to dependent (via mainframe) or independent control.	Page 171
6. Delay Time	Configure the load delay time for each channel. (0-10 seconds).	Page 173
7. Clear All Protection	Clear all the Protection Alarms.	Page 165
8. Time	Configure date time settings.	Page 183
9. Display	Adjust display settings.	Page 184
10. Control type	Configure the Knob control.	Page 188
11. Slave Knob Setting	Display Measured or Set values with the selector knob.	Page 192
12. Alarm	Configure alarm settings.	Page 190
13. Step resolution	Configure the step resolution. Applicable to CC high and low range, CR high and low range and CV high range.	Page 175
14. Sound	Turn the sound on/off for the mainframe IU.	Page 184

O PERATION

The PEL series operation is described in the chapters below. The sections are broken down into small operations. For thorough examples on the operation of the load generator, please see the tutorial section on page 97.

Local Mode Operation.....	112
Selecting a Channel	113
Selecting Static/Dynamic	114
Turning on the Load.....	115
Shorting.....	116
Display Output View	117
Editing CC /CR/CV A/B Value.....	118

Mainframe Basic Operation.....	119
Help Menu.....	120
Channel Selection	121
Select CC Mode	122
Select CC Range.....	123
Select CC Dynamic Mode.....	123
Editing CC Dynamic Parameters	124
Select CC Static Mode.....	126
Editing CC Static Parameters	126
Set to CR Mode.....	128
Select CR Range.....	128
Select CR Dynamic Mode	129
Editing CR Dynamic Parameters	130
Select CR Static Mode.....	132

Editing CR Static Parameters	132
Select CV Mode.....	134
Editing CV Parameters	135
Select CV Response Speed	137
Creating a Program Sequence	138
Program Chains	143
Running a Program	145
Edit Sequence	151
Create Sequence Loop.....	153
Channel Duration Time Settings	155
Run Sequence	157

Channel Configuration	160
Accessing the Configuration Menu.....	161
Setting (OCP/OVP/OPP/UVP)	162
Protection Clear	165
Setting the CC Voltage Range.....	165
Adjusting the Von Voltage and Latch..	167
Configuring the Short key.....	168
Configuring Channel Control.....	170
Configuring the Independent Setting .	171
Configuring the Load Delay Time	173
Configuring Step Resolution	175
Go/NoGo	177

Mainframe Configuration	180
Accessing System Information	181
Accessing the Load Menu	182
Configuring the Date and Time	183
Adjusting the Speaker	184
Adjusting the display settings	185
Adjusting the Frame Control	187

Adjusting the Knob Control Type.....	188
Configuring Alarm Sound.....	190
Configuring Go/NoGo Alarm Sound ..	191
Adjusting Slave Knob Settings	192
View Language Settings	194

Interface Configuration (settings).....	195
Configuring RS232 Connection	196
Configuring the GPIB Address	198
Configuring USB Remote Connection.	199

Save / Recall	201
Saving/Recalling Channels.....	202
Saving/Recalling Preset memory.....	204
Saving/Recalling Setup Memory	206
Setting the Default USB Path/File	208
Saving Setups to USB Memory.....	213
Saving/Recalling Memory Data to USB216	
Saving/Recalling Presets to USB.....	220
Saving/Recalling Sequences to USB... ..	224
Quick Preset Recall/Save	228
Recall Setup Memory (Frame link).	229
Recall Preset Memory (Frame link)	230
Recall Factory Defaults.....	231

Local Mode Operation

Each channel can be edited by its local load module. Depending on the configuration, local changes can be reflected on the mainframe. For this section all operations refer to knobs and buttons on the local load module panels, unless stated otherwise.

Local Mode Operation.....	112
Selecting a Channel	113
Selecting Static/Dynamic	114
Turning on the Load	115
Shorting.....	116
Display Output View	117
Editing CC /CR/CV A/B Value.....	118

Selecting a Channel

Background Each channel can be individually selected by using its load module panel. Changing channels on a load module only applies to dual channel load modules.

Single Channel Panel operation Press any key on a load module to select its channel.

Dual Channel Panel Operation For dual channel load modules, press any key on a load module that has the desired channel. Press the R/L key to cycle between the channels on the load module. L or R will be displayed on the bottom left hand to indicate which channel (left or right side) is active on the load module.



LR



Note

On single channel modules, pressing the A/B key repeatedly will change the level from A or B when in Static mode.

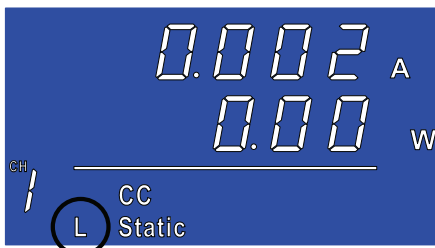

Selecting Static/Dynamic

Background Each load channel can be individually switched from Static to Dynamic using the local load module.

1. Select a channel on the load module. Page 113

Panel operation 2. Press the STATIC/DYNA. key to switch from dynamic to static mode and vice versa.

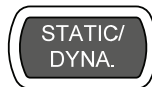

All changes will be shown on the display and depending on the configuration, reflected on the mainframe.

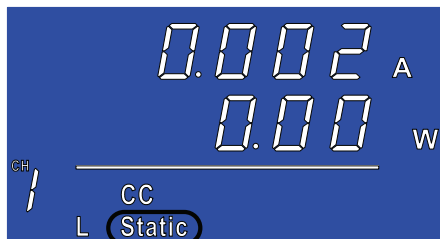

Turning on the Load

Background Loads can be individually selected to be turned on using local operation.

1. Select a channel on the load module. Page 113

Panel operation 2. Press the LOAD key to turn on the load.



When a channel load is activated, the load on symbol will be displayed under the channel number.

Range

- L-ON** Left channel
- R-ON** Right channel
- ON** Single channel

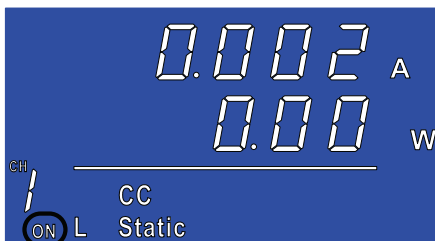

Turning the load off 3. Press the LOAD key.



Shorting

Background The short key can be set to toggle or hold.

1. Ensure the load is off.
2. Select a channel on the load module.

Page 113



Panel operation 3. Press the SHORT key to change between shorting modes.

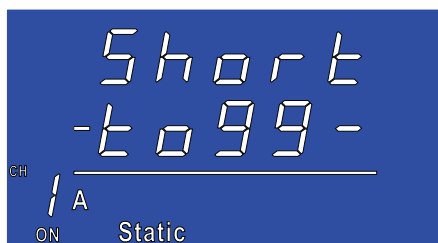
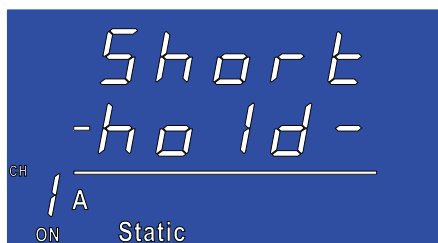

-hold- - When the load is on, the SHORT key needs to be held to short.

-to99- - When the load is on, the SHORT key can be used to toggle shorting on/off.



4. Press LOAD to turn on the load. 
- Shorting 5. a. Press the SHORT key (toggle mode). 
- Or
- b. Hold the SHORT key (hold mode).

Display Output View

Background The DISPLAY key can be used to switch the display output to different views.

- Panel operation 1. Press the DISPLAY key repeatedly to switch between the different views. 
- V** Voltage
- A** Current
- W** Power
- S** Load on time.

Editing CC /CR/CV A/B Value

Background The Selector Knob can be used to change the A Value and B Value (single channel load module) when in static mode.

Panel Operation 1. Ensure the mode is in static mode. Page 114

2. Choose a channel (or choose A or B Value) by pressing the R/L or A/B key.



3. Turn the Selector knob to edit the A/B Value for the selected mode.

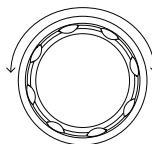

Note

When the Slave Knob is set to “Measured”, the selector knob must be pressed first to display the values on the load module display.

Mainframe Basic Operation

For the Mainframe Basic Operation section, all operations refer to the knobs and keys on the main configuration panel, unless otherwise stated.

Mainframe Basic Operation	119
Help Menu.....	120
Channel Selection.....	121
Select CC Mode.....	122
Select CC Range.....	123
Select CC Dynamic Mode.....	123
Editing CC Dynamic Parameters.....	124
Select CC Static Mode.....	126
Editing CC Static Parameters.....	126
Set to CR Mode.....	128
Select CR Range.....	128
Select CR Dynamic Mode.....	129
Editing CR Dynamic Parameters.....	130
Select CR Static Mode.....	132
Editing CR Static Parameters.....	132
Select CV Mode.....	134
Editing CV Parameters.....	135
Select CV Response Speed.....	137
Creating a Program Sequence.....	138
Program Chains.....	143
Running a Program.....	145
Edit Sequence.....	151
Create Sequence Loop.....	153
Channel Duration Time Settings.....	155
Run Sequence.....	157

Help Menu

Background When any function key has been pressed or when a menu has been opened, the HELP key can be used to display a detailed description.

1. Press a function or system key on the front panel or open a menu.

Mainframe Channel selection

2. Press the HELP key to display the built-in help.
3. Use the scroll wheel to scroll down if necessary.

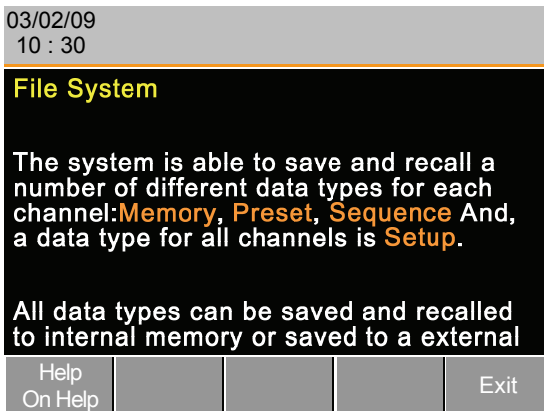
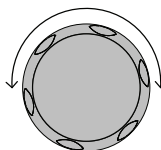
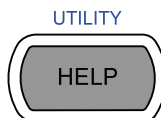

A detailed description of the function or menu item is shown.

4. Press F5 to exit.



Channel Selection

Background There are up to 2 channels per load module, depending on the model. The main display can be used to control each channel individually.

5. Press the CHAN button.

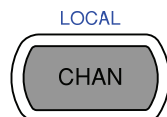

Mainframe Channel selection 6. Select a channel by turning the Variable knob.

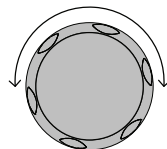

The channel selection appears highlighted in orange on the top right of the screen.

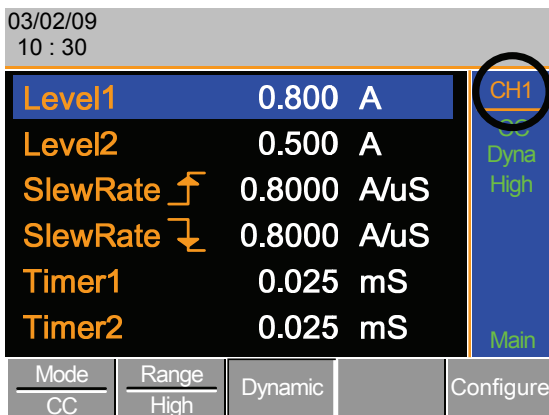

7. Press the Selector knob or Enter to confirm.



Select CC Mode

Background The PEL 2000 series load generators operate in three different modes: Constant Current (CC), Constant Resistance (CR), and Constant Voltage (CV).

When a channel is active, the F1 key can be used to switch between each operating mode.

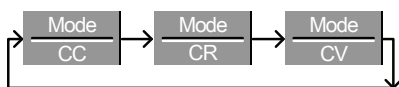

- Panel Operation**
1. Select a channel using the CHAN button and selector knob.
 2. Press F1 repeatedly until CC mode is displayed in the display panel.

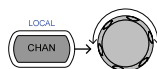

Mode CC	Range High	Dynamic		Configure
------------	---------------	---------	--	-----------



Changing the operating mode will only affect the current (active) channel. Other channels will not be affected by any changes.

Select CC Range

Background Constant current mode can run in high and low range. Maximum range is dependent on the load module.

Ensure the menu is in CC Mode. See page 122.

Mode	Range	Dynamic		Configure
CC	High			

- Panel Operation**
1. Press the F2 (Range) key repeatedly until High or Low range is selected.

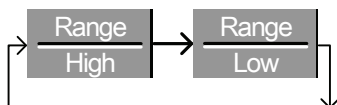
Note

Changing the range will only affect the current (active) channel. Other channels will not be affected by any changes.

Note, not all load modules support dual ranges. If only one range is supported, it is usually high range.

Select CC Dynamic Mode

Background Constant current mode can be set to dynamic or static mode. Dynamic mode is used to automatically set varying load rates.

Ensure the menu is in CC Mode. See page 122.

Mode	Range	Dynamic		Configure
CC	High			

- Panel Operation 1. Press the F3 key until Dynamic Range mode is selected.

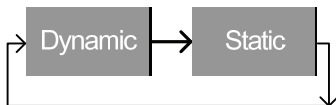

Note

Changing from static to dynamic mode will only affect the current (active) channel.

Editing CC Dynamic Parameters

Background

Dynamic Constant Current Mode has two operating current levels, slew rates and timers.

Slew rates determine the speed at which the load will change from one level to the next.

The timers determine how long the load module/channel will stay at level 1 or level 2.

Ensure the menu is in CC Dynamic Mode. See page 123.

Mode	Range	Dynamic		Configure
CC	High			

Parameters

Level1	0~rating A
Level2	0~rating A
SlewRate	↖ Load module dependent
SlewRate	↘
Timer1	0.025~30000.0 ms
Timer2	0.025~30000.0 ms

- Panel Operation 1. Use the Selector knob to highlight Level1.

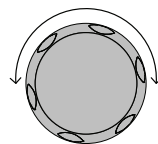

03/02/09			
10 : 30			
Level1	0.800	A	CH1
Level2	0.500	A	CC
SlewRate ↑	0.8000	A/uS	Dyna
SlewRate ↓	0.8000	A/uS	High
Timer1	0.025	mS	
Timer2	0.025	mS	Main
Mode	Range	Dynamic	Configure
CC	High		

2. Press the Selector knob to edit the selected level, then turn to increase or decrease the value.

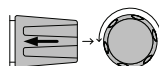

OR

Use the number pad to enter a number.



Level1 0.800 A

3. Press the Selector knob or Enter to confirm selection.



4. Repeat steps 1-3 for the remaining parameters.



Note

Level1 & Level2 can be set for both High and Low Range.

Select CC Static Mode

Background Constant current mode can be set to dynamic or static mode. Static mode is for manually varying the load for single channel load modules or to set a static load on dual channel modules.

Ensure the menu is in CC Mode. See page 121.

Mode CC	Range High	Dynamic		Configure
------------	---------------	---------	--	-----------

Panel Operation 1. Press the F3 key until Static mode is selected.

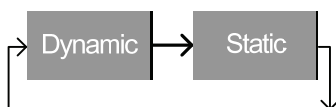

Note

Changing from static to dynamic mode will only affect the current (active) channel.

Editing CC Static Parameters

CC Values When using a single channel load module, Static Constant Current Mode has two operating current values A&B. If a dual channel load is used, only one current value is available per channel: A Value.

Ensure the menu is in CC Static Mode. See page 126.

Mode CC	Range High	Static	Seq. Edit	Configure
------------	---------------	--------	--------------	-----------

Parameters	A Value	0~rating	A
	B Value	0~rating	A
	SlewRate	↕	Load module dependent
	SlewRate	↘	

- Panel Operation 1. Use the Selector knob to highlight A Value.

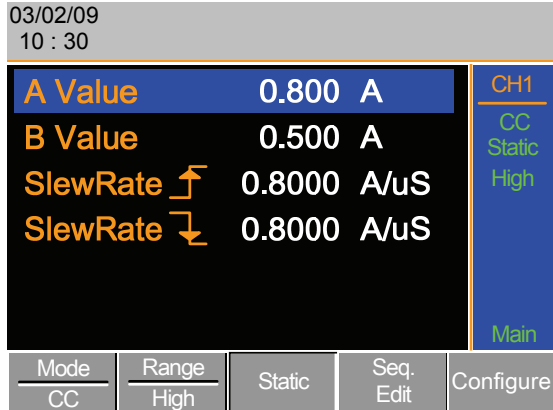
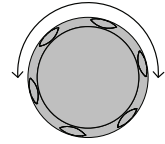

2. Press the Selector knob to edit the selected value, then turn to increase or decrease the value.

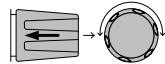

OR

Use the number pad to enter a number.

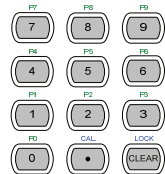

3. Press the selector knob or Enter to confirm selection.
4. Repeat steps 1-3 for the remaining parameters.



A & B Value have the same Range: High or Low.

Set to CR Mode

Background The PEL 2000 series load operates in three different modes, Constant Current (CC), Constant Voltage (CV), Constant Resistance (CR). Constant Resistance mode will maintain a constant resistive load, using variable current and voltage levels.

When a channel is active, the F1 key can be used to switch between each operating mode.



Panel Operation 1. Press the CHAN button and use the selector knob to select a channel.

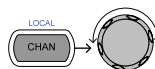

2. Press F1 until CR mode is displayed in the display panel.



Mode CR	Range Low	Dynamic		Configure
------------	--------------	---------	--	-----------



Note

Changing the operating mode will only affect the current (active) channel. Other channels will not be affected by any changes.

Select CR Range

Background Constant Resistance mode can run in high and low range. Range is dependent on the load module.

Ensure the menu is in CR Mode. See page 128.

Mode CR	Range Low	Dynamic		Configure
------------	--------------	---------	--	-----------

- Panel Operation 1. Press the F2 (Range) key repeatedly until High or Low range is selected.

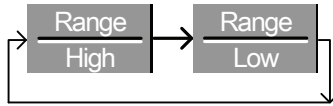

The range will be reflected in both the bottom menu system and the Current Operation Channel Status panel.



Low range Low
 High range High



Note

Changing the range will only affect the current (active) channel. Other channels will not be affected by any changes.

All resistance values and slew rates are dependent on Range, i.e., A Value in low range can be different from A Value in high range.

Select CR Dynamic Mode

Background Constant Resistance mode can be set to dynamic or static mode. Dynamic mode is used to automatically set varying load rates.

Ensure the menu is in CR Mode. See page 128.

Mode	Range	Dynamic		Configure
CR	Low			

- Panel Operation 1. Press F3 until Dynamic Range mode is selected.

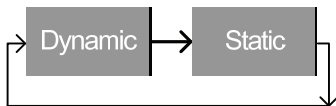

Note

Changing from static to dynamic mode will only affect only the current (active) channel.

Editing CR Dynamic Parameters

CC levels

Dynamic Constant Resistance Mode has two operating resistance Levels, slew rates and timers.

Slew rates determine the speed at which the load will change from one level to the next.

The timers determine how long the load module/channel will stay at level 1 or level 2. See the CR operating description for details about slew rates and timers, page 65

Ensure the menu is in CR Dynamic Mode. See page 129.

Mode	Range	Dynamic		Configure
CR	Low			

Parameters

Level1	Minimum ~ rating Ω
Level2	Minimum ~ rating Ω
SlewRate	↖ Load module dependent
SlewRate	↘
Timer1	0.025~30000.0ms
Timer2	0.025~30000.0ms

- Panel Operation 1. Use the Selector knob to highlight Level1.

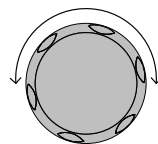

03/02/09			
10 : 30			
Level1	100.000	Ω	CH1
Level2	100.000	Ω	CR
SlewRate	0.4000	A/uS	Dyna
SlewRate	0.4000	A/uS	Low
Timer1	0.025	mS	
Timer2	0.025	mS	
			Main
Mode	Range	Dynamic	Configure
CR	Low		

2. Press the Selector knob to edit the selected level, then turn to increase or decrease the value.

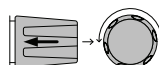

OR

Use the number pad to enter a number.



Level1 100.000 Ω

3. Press the Selector knob or Enter to confirm selection.
4. Repeat steps 1-3 for the remaining parameters.

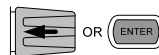

Note

Level1 & Level2 can be set for both High and Low Range.

Select CR Static Mode

Background Constant Resistance mode can be set to dynamic or static mode. Static mode is for manually varying the load for single channel load modules or to set a static load on dual channel modules.

Ensure the menu is in CR Mode. See page 128.

Mode	Range	Dynamic		Configure
CR	Low			

Panel Operation 1. Press the F3 key until Static mode is selected.

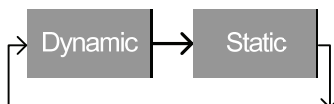

Note

Changing from static to dynamic mode will only affect the current (active) channel.

Editing CR Static Parameters

Background Single channel load modules have two resistance levels, A Value & B Value. Dual channel load modules have only one resistance level per channel, A Value.

Ensure the menu is in CR Static Mode. See page 132.

Mode	Range	Static	Seq. Edit	Configure
CR	Low			

Parameters	A Value	0~rating	Ω
	B Value	0~rating	Ω
	SlewRate	↕ Load module dependent	
	SlewRate	↘	

- Panel Operation 1. Use the Selector knob to highlight A Value.

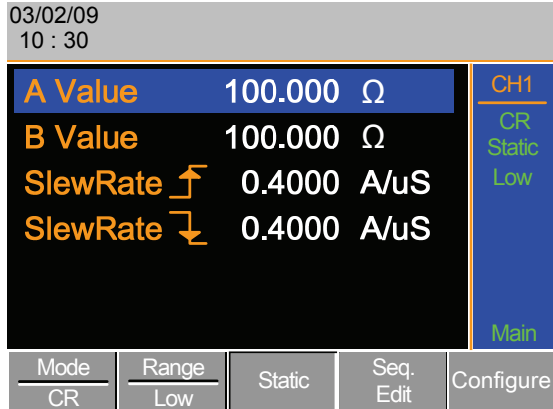
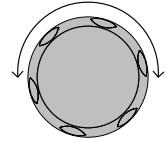

2. Press the Selector knob to edit A Value / B Value, then turn to increase or decrease the value.

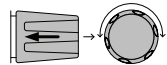

OR

Use the number pad to enter a number.

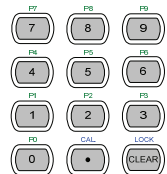

3. Press the selector knob or Enter to confirm selection.

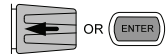

4. Repeat steps 1-3 for B Value (if applicable), rising and falling SlewRate.



A/B Value and rising/falling SlewRate can be set for both High and Low Range.

Select CV Mode

Background The PEL 2000 series electronic load operates in three different modes, Constant Current (CC), Constant Resistance (CR), and Constant Voltage (CV).

When a channel is active, the F1 key can be used to switch between each operating mode.

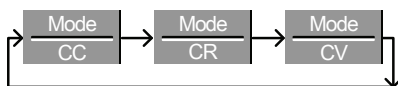

Panel Operation 1. Press the CHAN button and use the selector knob to select a channel.

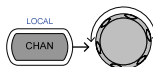

2. Press F1 until CV mode is displayed in the display panel.



Changing the operating mode will only affect the current (active) channel. Other channels will not be affected by any changes.

CV mode only operates in High range.

Editing CV Parameters

Background Constant Voltage mode can be set to a maximum limit (Curr Limit). Using the current limit enables limiting the current draw.

When using CV mode on single channel load modules, two voltage levels can be sunk, A Value and B Value. On a dual channel load module, only one voltage level can be sunk per channel: A Value.

Ensure the menu is in CV Mode. See page 134.

Mode		Response		Configure
CV		Slow		

Parameters	A Value	0~rating	V
	B Value	0~rating	V
	Curr Limit	Load module dependent	

Panel Operation 1. Use the Selector knob to highlight A Value.

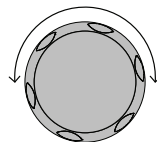



2. Press the Selector knob to edit the selected value, then turn to increase or decrease the value.

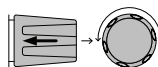

OR

Use the number pad to enter a number.



3. Press the selector knob or Enter to confirm selection.
4. Repeat steps 1-3 for the remaining parameters.



 **Note**

When setting the current limit, please ensure that the current limit is within the test device's limits.

Select CV Response Speed

Background Constant voltage mode has fast and slow response speeds. Quick current changes can induce line voltage, making it more difficult for the PEL load generator to maintain a constant current. In these types of conditions, slow response speed is recommended. Maximum current range is dependent on the load module type.

Ensure the menu is in CV Mode. See page 134.



- Panel Operation**
1. Press F3 (Response) to switch between Fast and Slow response speeds.

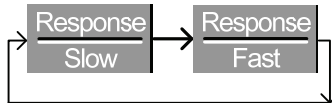

Response speed settings will be reflected in the Current Operation Channel Status panel.

Slow response speed Slow
Fast response speed Fast



Changing the response speed will only affect the current (active) channel. Other channels will not be affected by any changes.

Creating a Program Sequence

Background

The PEL series has a total of 12 different programs and 10 sequences to each program. That totals to 120 different configurations.

Each Sequence in each program uses the settings saved from Memory Data (Memory MXXX). Memory Data contains settings such as the mode and range for each channel. Different Sequences can use the same Memory Data repeatedly. Each Sequence loads all channels at the same time, unless programmed otherwise.

Sequence1	
CH1 M001	Run
CH2 M001	On-Time
CH3 M001	Off-Time
CH4 M001	Short-Time
CH5 M001	P/F-Time
CH6 M001	Short CH1
CH7 M001	~
CH8 M001	Short CH8

Sequences are run sequentially to create a Program. There are 10 Sequences in each Program.

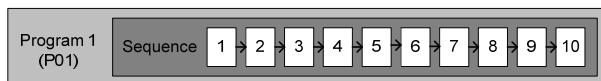

If less than 10 Sequences are desired for a Program, any additional Sequences can be skipped (not run).

Sequence 2 & 3 are skipped.

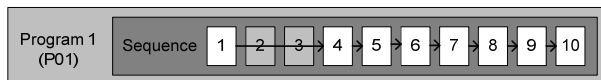

Parameters	Memory	M001~M120
	Run	Skip-Auto-Manual
	On-Time	0.1 ~ 60.0 S
	Off-Time	Off - 0.1 ~ 60.0 seconds
	P/F Time	Off - 0.1 ~ (On-Time+Off-Time)-0.1
	Short-Time	Off - 0.1 ~ On-Time

Sequence Settings

1. Press the FUNC key then F1 (Program) to access the Program menu.

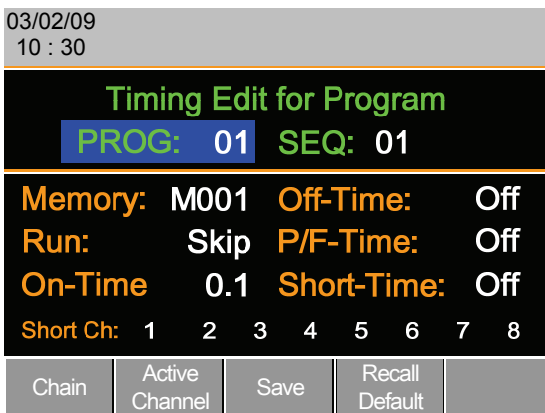
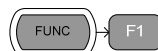

2. Use the Selector Knob to highlight PROG:.

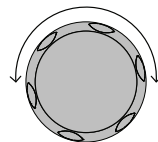

- Press the selector knob to edit PROG., then turn to select the program number.

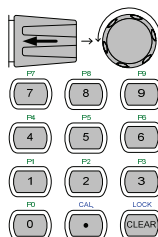

OR

Use the number pad to enter a program number.

Program: 01 ~12

- Press Enter or push the selector knob to confirm.

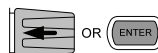

- Repeat steps 2-4 to choose the sequence number (SEQ:).

Sequence: 01 ~ 10

As sequences are executed sequentially, start at SEQ: 01.

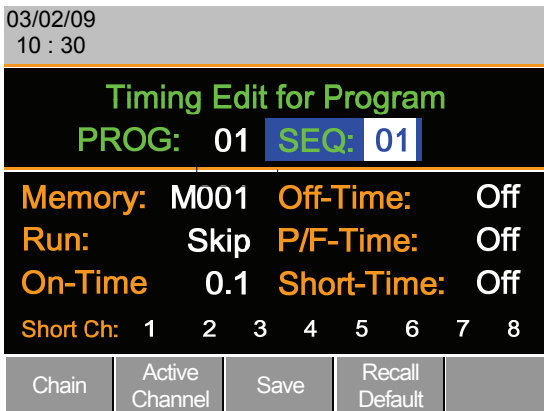

- Repeat steps 2-4 to configure the following for the current Program Sequence:

Memory: M001 ~M120

Choose which Memory data will be used for the sequence. CH1 MXXX ~ CH8 MXXX.

Run: Skip – Auto - Manual

Choose whether to run the sequence in the program automatically, skip the sequence or manually start the sequence.

On-Time: 0.1 ~ 60.0 seconds

Determines how long the sequence will run for (seconds).

Off-Time: Off – 0.1 ~ 60.0 seconds

Sets how long the sequence will stay off for (in seconds) between each sequence. Assuming Short time is not set to OFF, Off-Time will always run after On-Time.

Short Time: Off – 0.1 ~ On-Time (seconds)

Determines how long a short circuit will last (seconds). However the shorting time cannot be longer than the On-time. Short Time will start at the same time as On-time.

P/F Time: Off – 0.1 ~ (On-Time+Off-Time)-0.1 (seconds)

The Pass(P)/Fail(F) Time can be set to 0.1 seconds less than the total test time. The total test time is defined as:

$$\text{On-Time} + \text{Off-Time (seconds)}$$

If Go/NoGo is turned on but the pass fail time is off, then Go/NoGo test will continue, but there will not be a specified pass/fail time window.

Short Channel: Off – 1~ 8 (CH1~CH8)

Each channel can be individually set to simulate a short circuit (CH1~8) or can have shorting disabled (Off). When Short Channel is set to Off, the channel is enabled.

- Repeat the above steps for all ten sequences for the same (current) program.

Save Sequence

- Press F3 (Save) to save all the sequence data for the current program.



Note

Note the program data is not yet saved into Setup Memory. If you wish to save the Program to Setup Memory see page 204.

Recall Default

- To recall the Default Program settings, press F4.



Note

If the Default is recalled, all data will be lost. This does not include the internal Setup Memory. To see the default settings, see page 251.

Program Chains

Background On the PEL 2000, there are up to 12 different programs containing 10 sequences.

If 10 sequences in a Program Sequence prove to be inadequate for testing, the PEL2000 series can chain different programs together, effectively making a larger Program Sequence. .

Unlike Program Sequences, Program Chains do not need to be run in numerical order. Up to 12 Program Sequences can be chained together

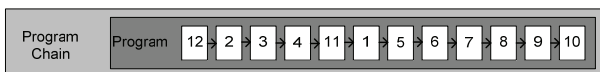

- Panel operation**
1. Create 1 or more Program Sequences. Page 138
 2. If Program Sequences were created in a different session, ensure the programs have been loaded from Setup Memory. Page 204
 3. Press the FUNC key, then Program (F1), followed by Chain (F1).

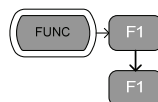

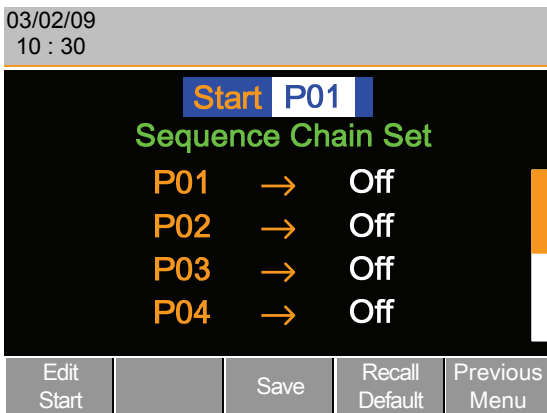

4. Use the selector knob to edit Start and confirm which Program Sequence (PXX) will start the program chain. Any Program (P01~P12) can be used to start a Program Chain.

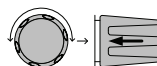

5. Use the Selector knob to scroll down to P01 (Program 1).

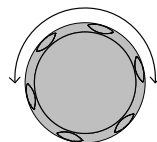

6. Use the Selector knob to choose the program that will execute after P01 (P02~P12).

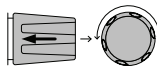

OR

Select (Off) to end the Program Chain after (P01).

OR

Select (P01) to execute after P01, this will create a continuously looping Program Chain.

P01 → Off – P01~P12

- Repeat the above procedure to P02~P12 to complete the program chain.

The Program Chain ends at the first Program (PXX) that is followed by Off. It is possible to create continuously looping program chains.

Save Program Chain

- Press F3(Save) to save the program chain.



Note

Note the Program Chain data is not yet saved into Setup Memory. If you wish to save the Program Chain to Setup Memory see page 204.

Recall Default

- To recall the Default program chain, press F4.



Note

If the Default is recalled, Start will revert to P01 and all program sequences will be set to Off.

Previous Menu

- Press F5 (Previous Menu) to return the Sequence menu.



Running a Program

Background

Once a Program Chain/Program Sequence has been created, it can be executed. As Program Sequences apply to all the channels, any channels that don't need to be active (load off) can be programmed in the Active Channel menu. At Default, all channels are set to (load) Off.

EXT will be shown next to any channels set to external channel control.

Panel operation

- Create 1 or more Program Sequences. Page 138.
- Create a Program Chain. Page 143.

3. Press the FUNC key, Program (F1) and Active Channel (F2).

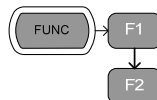

Channel 1 (CH01) will be highlighted. Note CH1 has CH CONT set to External

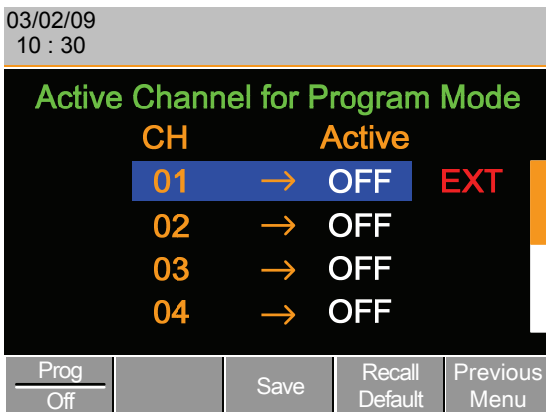

4. Edit the channel using the Selector knob.

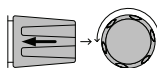

CH 01~08: ON (activate channel) – OFF (not activated)

5. Press Enter or push the selector knob to confirm the selection.

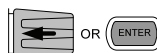

6. If needed, repeat steps 4-5 for the remainder of the channels.



Note

If all channels are Active OFF, a program cannot be run as there will be no channels active.

Save Program

7. To save press F3.



Recall Default

8. To recall default settings press F4



Note

If the Default is recalled, all channels will revert to Active OFF.

Previous Menu 9. Press F5 (Previous Menu) to return to the Sequence menu. 

Turn Program On/Off 10. Press F1 (Prog) to turn On or Off the current Program. 

Pressing F1 will cycle from Program On to Off.

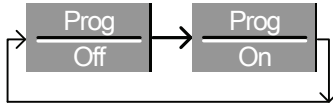

11. PROG will appear on the mainframe status panel when the program is turned on.



Run Program 12. Press the load key on the mainframe to start the Program. 

13. The Run Program screen appears.



As each sequence or program is completed the screen will update to display the active sequence/program. Notice that if a channel has been set up with Go/NoGo limits, a pass (GO) or fail (NG) will be displayed on the main display as well as the local load module display.

The program icon will become orange when a program has started.



Note

If the Active=OFF for all the channels then “No Active Channel” will be displayed instead of channel numbers.

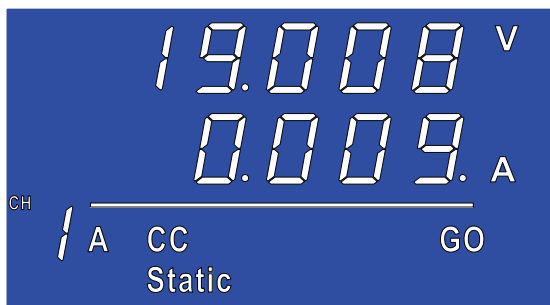

Each active load module will display the output as the program runs.

14. If Run was configured to manual in any of the program sequences, press F2 (Next) to continue the program sequence, otherwise the program will continue automatically.

F2

15. Press F1 (Stop) at any time to abort the program when it is running.

F1

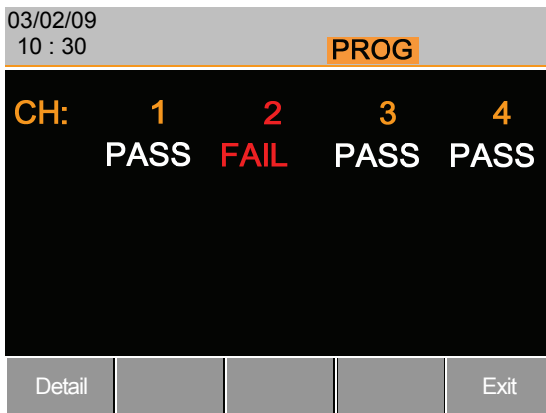

When the program has finished, the physical channels that have run will be displayed, a PASS or FAIL will be displayed if Go/NoGo testing has been set.

- When the program has finished, press F1 to see any result details.



The Program (P) and Sequence (S) numbers for the Program are displayed on the left hand side and the Go/NoGo (G/N) results are displayed on the right hand side for each channel in the program.

Use the Selector knob to scroll down to view the remainder of the list if necessary.

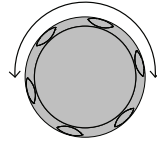

17. Press F5 to exit at any time.





Upon exiting, the previous menu before running the program will load.

Edit Sequence

Background The Sequence function can be configured to create a unique load profile to accurately simulate loads in real time for single or multiple loads. For details see page 74.

Each Sequence is composed of a number of points with customizable current/resistance, slew rate and duration times. Each sequence can be looped an infinite amount of times. Sequences are only applicable for CC (Static) and CR (Static) modes.

Parameters	Value	0~rating*1.02 Ω / A
	SlewRate 	Load module dependent
	SlewRate 	
	Duration Time	0.0001~60,000 seconds

- Panel operation**
1. Choose a channel and mode. Page 119, 122
 2. Press the CHAN key, F4 (Seq. Edit) to enter the Sequence Edit menu.

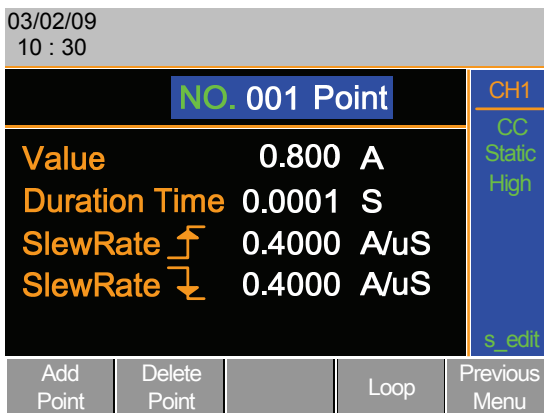
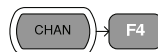

- Use the Selector knob to highlight Value.

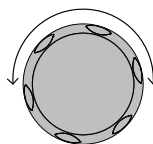

- Press the Selector knob to edit the Value, then turn to increase or decrease the value.

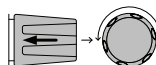

OR

- Use the number pad to enter a number.

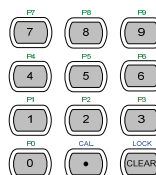

Value 0.800 **A**

- Press the Selector knob or Enter to confirm selection.

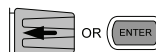

- Repeat for rising and falling Slew Rate and Duration Time.

Add Point

- To add an extra point after the current point, press Add Point (F1).



Range 001~120



Note

Add Point will insert a new point directly after the current point. The value of the current/resistance of the inserted point will be the average of the point before and after. All other settings will remain unchanged.

Delete Point

- To delete the current point, press Delete Point (F2).



Edit previous point

- Use the selector knob to change the current point number.

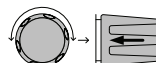

NO. 001 **Point**



Note

The Point number can only be changed if more points have already been added.

Save Sequence

11. Press Save (F3) to save the sequence.



Note

The save icon will only appear after a change has been made in the menu.

Create Sequence Loop

Background

Sequences can be looped a number of times. The loops can be started at any point in the sequence. The Start of Loop function determines which point will start each repeating loop.

The On End Load function will set the load to on or off at the end of a sequence until the end of the last sequence.

CC Vrange sets the range in CC mode for Sequences.

See page 74 for more details.

Ensure the menu is in the Seq. Edit menu and that a sequence has been created. See page 151

Add Point	Delete Point		Loop	Previous Menu
-----------	--------------	--	------	---------------

Parameters

Repeat 1~9999/0=Infinite

Start of Loop 001~ last point

On End Load OFF / ON

CC Vrange High/Low

Panel operation

1. Press Loop (F4) to enter the Loop menu.

03/02/09		10 : 30	
Repeat	0005	Times	CH1
Start of Loop	001	Point	CC
On End Load	ON		Static
CC Vrange	High		High
			s_loop
			Previous Menu

- Use the Selector knob to highlight Repeat.

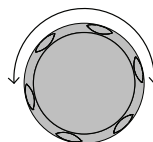

- Press the Selector knob to edit Repeat, then turn to increase or decrease the value.

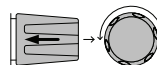

OR

- Use the number pad to enter a number.



Repeat 0005 **Times**

- Press the Selector knob or Enter to confirm selection.
- Repeat for the remaining parameters.



Save Loop

- Press Save (F3) to save the loop.



Channel Duration Time Settings

Background Each sequence can have the timing duration data of another sequence. For example CH1's sequence can import the timing duration settings of CH2's sequence.

This is useful to quickly compare two different loads to the same timing characteristics. See page 74 for more details.

Each channel's sequence can be turned off by configuring the channel Setting to OFF. If a channel uses the same channel number, i.e CH 01 → 01, then the duration time settings will not be altered for that channel.

One channel must output a Trigger Sequence Signal via PIN4 of the frame link connector if a sequence is run. For more details see page 74.

Any channels with channel control (CH CONT) set to external will be shown on the right side as EXT.

Parameter	CH 01~08	Range OFF ~ maximum channels
	TRIG	OUT

Ensure at least one sequence has been created and saved. Page 151

- Panel operation**
1. Press FUNC, then Sequence (F2) to enter the Channel Duration Time menu.

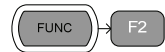

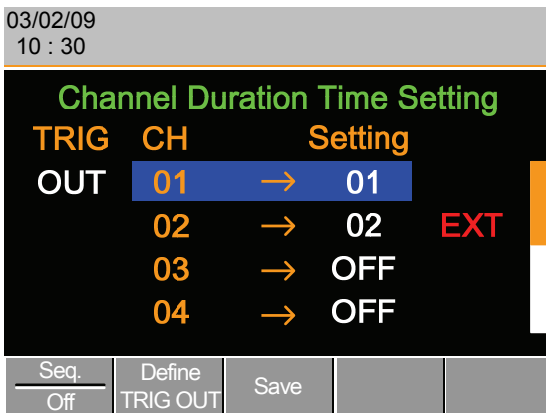

Note CH1 is used as the trigger source. CH2 has CH CONT set to external.

- Use the Selector knob to highlight a channel.
- Press the Selector knob to edit the channel, and then turn to choose which channel's Duration Time Setting to import.

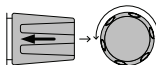
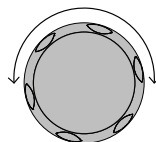

Range Ch 01~08 / OFF



- Press the Selector knob or Enter to confirm selection.
- Press Define TRIG OUT (F2) if you want the currently selected channel to output the Trigger sequence signal.
- Repeat for any other channel.

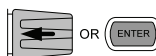

Trigger Out Channel

- Press Save (F3) to save the settings.

 A rectangular button with rounded corners and a grey gradient, containing the text "F3" in white.

Run Sequence

Background Like Programs, Sequences must be turned "ON" before they can be run.

When running a Sequence, the front panel function keys, number pad, operation keys and selector knob are disabled for the specific channel(s). The load module panel is also disabled (bar the display key) for the specific channel.

Channels that do not have a Sequence can still be edited by changing channels via the CHAN key or by using the local load module.

Ensure at least one Sequence has been created and saved. [Page 151](#)

Ensure the Channel Duration Time Settings have also been configured and that no Sequence (CH01~08) that you wish to run are set to OFF. [Page 155](#)

- Panel operation**
- Press FUNC, then Sequence (F2) to enter the Channel Duration Time Setting menu.

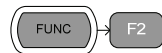

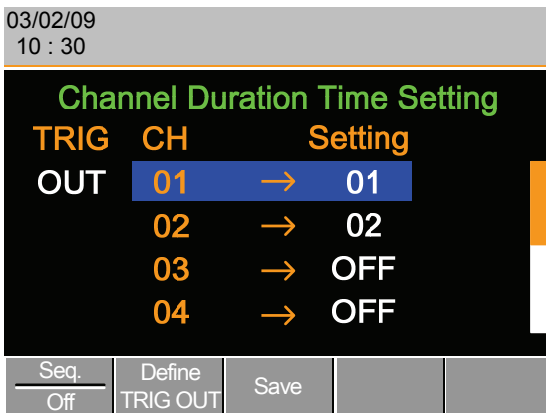

2. Press Seq. (F1) to turn on the Sequences.



3. SEQ will be displayed on the Mainframe Status panel.



4. Press the LOAD key to run all the Sequences.

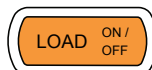

5. Run SEQ Mode will be displayed on the bottom of the display for the specific channels.

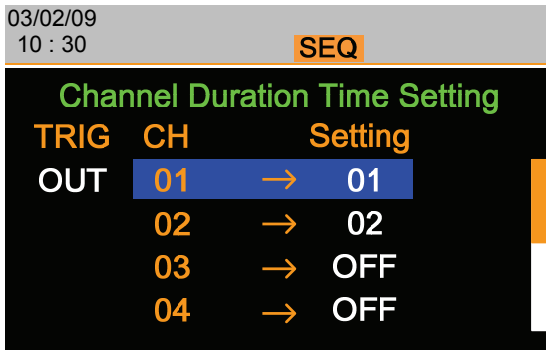

Run SEQ Mode

Stop the load

6. Press the LOAD key again or wait for the Sequence (if not infinitely looped) to end/stop the load.



Turn off SEQ

7. Press Seq. (F1) to turn OFF the Sequence(s) when the load is not running.



All UI keys/dials will be disabled for all channels that run a Sequence, bar the function keys and R/L keys.

Channel Configuration

The Channel Configuration chapter describes the configuration options for individual channels. Any configuration settings that are changed only apply to the current channel, other channels will not be changed.

Channel Configuration	160
Accessing the Configuration Menu.....	161
Setting (OCP/OVP/OPP/UV)	162
Protection Clear	165
Setting the CC Voltage Range	165
Adjusting the Von Voltage and Latch..	167
Configuring the Short key.....	168
Configuring Channel Control.....	170
Configuring the Independent Setting .	171
Configuring the Load Delay Time	173
Configuring Step Resolution	175
Go/NoGo	177

Accessing the Configuration Menu

Background The configuration menu is used to access instrument settings and properties as well as set the protection levels for each channel.

- Panel operation**
1. Select the channel to be configured by pressing the CHAN key and using the Selector knob.
 2. Press the F5 (Configure) key to enter the configuration (Protection) menu.

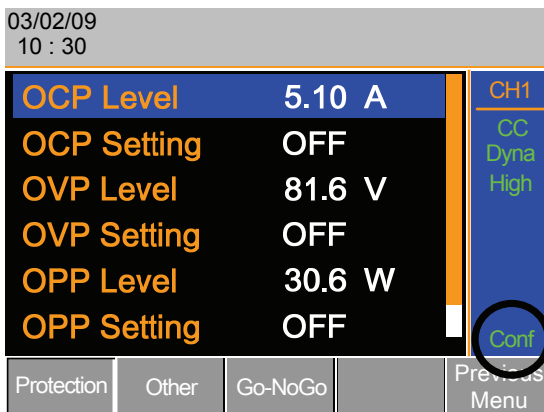
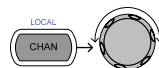

Setting (OCP/OVP/OPP/UVP)

Background Over Protection is used to set the voltage, current or power limit. In the event that the current, voltage or power exceeds the over protection settings, the load module alarm will show an error message and beep an alarm.

When tripped, Under Voltage Protection (UVP) will turn off the load. UVP trips when the load voltage drops below a set limit.

Only when the protection settings are set to On (XXP Setting -On) will the protection modes be active.

All protection settings can be set to 2% higher than specification rating.

Parameters	OCP Level	0~Rating A +2%
	OCP Setting	ON/OFF/Clear
	OVP Level	0~RatingV+2%
	OVP Setting	ON/OFF/Clear
	OPP Level	0~RatingW+2%
	OPP Setting	ON/OFF/Clear
	UVP Level	0~RatingV+2%
	UVP Setting	Clear

Panel operation Ensure the menu is the configuration menu. See page 160.



03/02/09 10 : 30			
OCP Level	5.10 A		CH1
OCP Setting	OFF		CC
OVP Level	81.6 V		Dyna
OVP Setting	OFF		High
OPP Level	30.6 W		
OPP Setting	OFF		
			Conf
Protection	Other	Go-NoGo	Previous Menu

1. Use the Selector knob to highlight OCP Level.

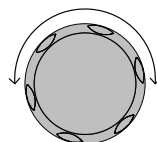

2. Press the Selector knob to edit the selected level, then turn to increase or decrease the value.

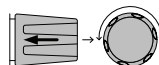

OR

3. Use the number pad to enter a number.



OCP Level

5.10 A

4. Press the Selector knob or Enter to confirm selection.



5. Use the Selector knob to highlight OCP Setting.

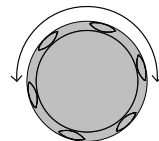

- Use the selector knob to turn ON, OFF or CLEAR the OCP Setting.

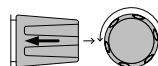

- Repeat steps 1-5 for :

- OVP Level
- OVP Setting
- OPP Level
- OPP Setting
- UVP Level
- UVP Setting

Clearing an Alarm When any of the protection settings are tripped, Alarm will be shown on the Mainframe Status Panel and an alarm tone will sound by default.



- Turn the load off by pressing the Load key and turn off the load input.
- Change the XXP Setting to Clear to clear the alarm.



See pages 59 and 239 to output alarms via the Go/NoGo output terminal.

The configuration settings only apply to the current channel.

Protection Clear

Background When any of the protection circuits have been tripped, the Protection Clear function can be used to reset the alarms.

Panel operation Ensure the menu is in the configuration menu. See page 160.



1. Turn the load off by pressing the load key if necessary.



2. Use the selector knob to scroll down to Protection Clear.

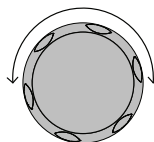

3. Press the Selector knob or Enter to clear all.



Note

The configuration settings only apply to the current channel, other channels will not be affected.

Setting the CC Voltage Range

Background The Constant Current Voltage range can be set to high or low.

Parameter CC Vrange High/Low

Panel operation Ensure the menu is in the configuration menu. See page 160.



1. Press the F2(Other) key to enter the Other menu.

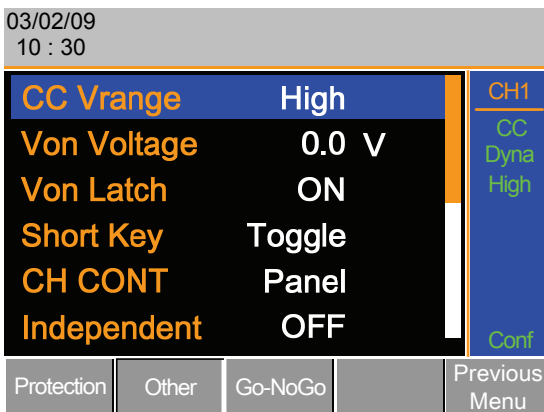

2. Use the Selector knob to highlight CC Vrange.

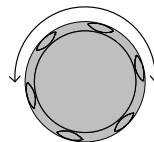

3. Press the Selector knob to edit CC Vrange, then turn to increase or decrease the range.

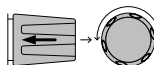

CC Vrange **High**

4. Press the Selector knob or Enter to confirm selection.

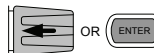

Note

The configuration settings only apply to the current channel.

Adjusting the Von Voltage and Latch

Background The Von Voltage is the voltage point at which the load module will start to sink current. When Von latch is set to ON, the load will continue to sink current after being tripped, even if the voltage drops below the Von Voltage level. The step resolution of Von Voltage is load module dependent.

Parameters Von Voltage 0.0~Rating volts
 Von Latch ON/OFF

Panel operation Ensure the menu is in the configuration menu. See page 160.



1. Press the F2(Other) key to enter the Other menu.

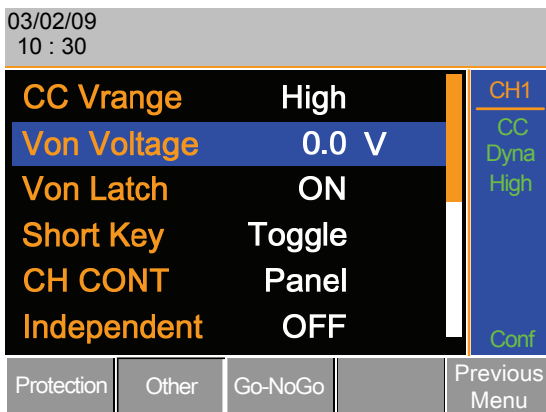

2. Use the Selector knob to highlight Von Voltage.

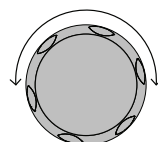

- Press the Selector knob to edit the selected value, then turn to increase or decrease the value.

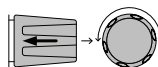

OR

Use the number pad to enter a number.



Von Voltage **0.0 V**

- Press the Selector knob or Enter to confirm selection.
- Repeat steps 3 to 5 to turn Von Latch ON or OFF

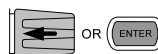

For details about Von and Latch settings please see page 81.



Note

The configuration settings only apply to the current channel, other channels will not be affected.

Configuring the Short key

Background The Short Key is used to simulate a short circuit. The Short key can be configured to toggle (press SHORT on the load module to toggle ON or OFF) or to Hold (the SHORT key is held to short the load).

Parameter Short Key Hold/Toggle

Panel operation Ensure the menu is in the configuration menu. See page 160.



1. Press the F2(Other) key to enter the Other menu.

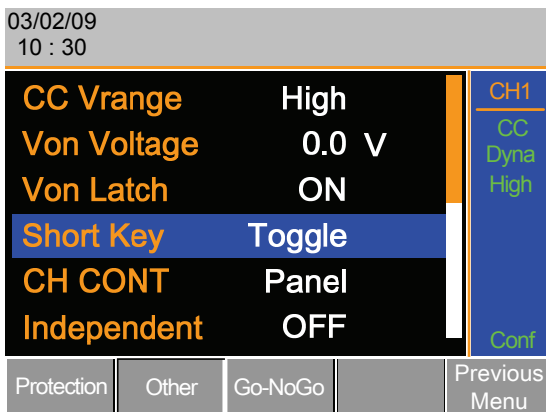

2. Use the Selector knob to highlight Short Key.

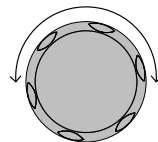

3. Press the Selector knob to edit the selected setting, turn to change the setting.

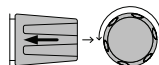

Short Key **Toggle**

4. Press the Selector knob or Enter to confirm selection.

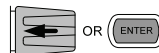

 **Note**

The short key can only be used when the load is on.

Configuring Channel Control

Background When Channel Control (CH CONT) is set to External, it will disable editing the active channel load. Instrument buttons and knobs can still be used to access the menu for the active channel or to edit other channels that do not have channel control active. This prevents settings on the active channel from being changed on the local machine. See pages 56 & 85 for details.

Parameter CH CONT Panel/External

Panel operation Ensure the menu is in the configuration menu. See page 160.



1. Press the F2(Other) key to enter the Other menu.

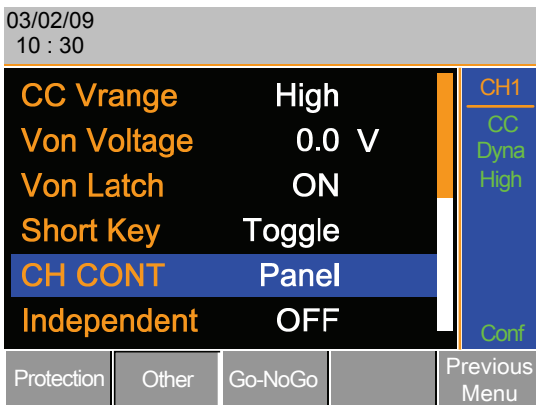

2. Use the Selector knob to highlight CH CONT.

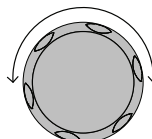

3. Press the Selector knob to edit the selected setting, turn to change the setting from Panel to External.

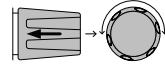

CH CONT External

4. Press the Selector knob or Enter to confirm selection.



Channel control is now activated. To turn Channel Control off, CH CONT must be set to Panel again. When Channel Control is active, EXT will be displayed on the side panel for the active channel.



Note

Channel Control can only be activated on the active channel; other channels will not be affected.

Configuring the Independent Setting

Background

The Independent setting allows a channel to be load independent from the mainframe. What this means is that a load module with Independent set to ON can only load from the local load module. If the LOAD ON/OFF key is pressed from the mainframe, the channel with Independent set to ON will be unaffected by the mainframe, except when running a program.

Parameter	Independent ON/ OFF
-----------	---------------------

Panel operation Ensure the menu is in the configuration menu. See page 160.



1. Press the F2(Other) key to enter the Other menu.

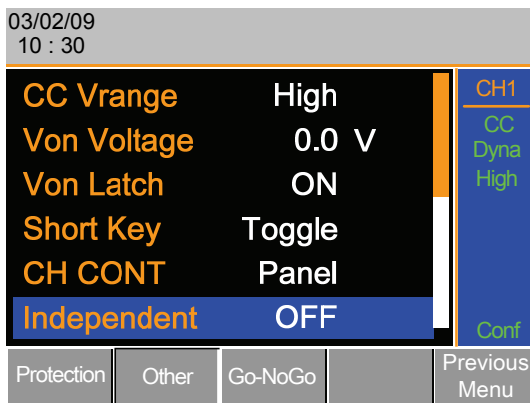

2. Use the Selector knob to highlight Independent.

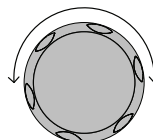

3. Press the Selector knob to edit the selected setting, turn to change the setting.

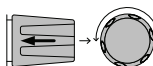

4. Press the Selector knob or Enter to confirm selection.





Note

When a channel has been set to independent, an asterisk will be shown next to the channel number indicator in the Current Operation Channel Status panel.

The configuration settings only apply to the current channel, other channels will not be affected.



Configuring the Load Delay Time

Background The mainframe can delay loading a channel by up to 10 seconds. However the Delay Time is only applicable for manual loading. Delay Time is not applicable to Programs or Sequences.

Parameter Load D-Time 0~10 S

Panel operation Ensure the menu is the configuration menu. See page 160.



1. Press the F2(Other) key to enter the Other menu.



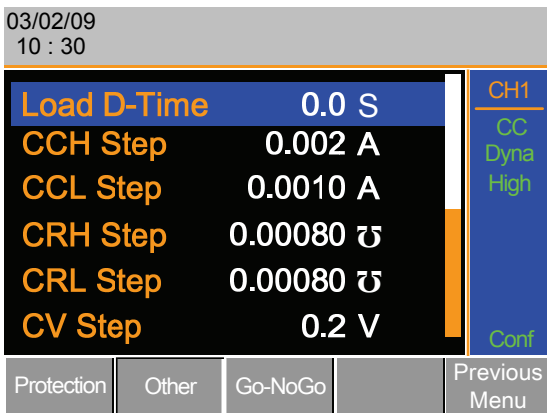

- Use the Selector knob to highlight Load D-Time.
- Press the Selector knob to edit the selected setting, turn to change the setting.

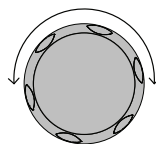

Note: Load D-Time is below Independent, off-screen.

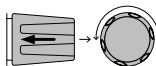

OR

Use the number pad to enter a number.



Load D-Time **0.0 S**

- Press the Selector knob or Enter to confirm selection.



Note

The Delay Time only applies to the current channel; other channels will not be affected.

Delay time only applies when the load is manually turned on or during start up with the Auto Load On setting (page 182).

Configuring Step Resolution

Background The CC, CV and CR step resolution settings can be edited in the configuration menu. The minimum and maximum step resolution of each channel is dependent on the load module. For more information on step resolution see page 81.

Parameters	Minimum*	Maximum*	Unit
CCH Step	HR/4000	HR/2	Amperes A
CCL Step	LR/4000	LR/2	Amperes A
CRH Step	HR/4000	HR/2	Siemens Ω
CRL Step	LR/4000	LR/2	Siemens Ω
CV Step	HR/4000	HR/2	Voltage V

* HR = High range, LR = Low range

Panel operation Ensure the menu is the configuration menu. See page 160.



1. Press the F2(Other) key to enter the Other menu.

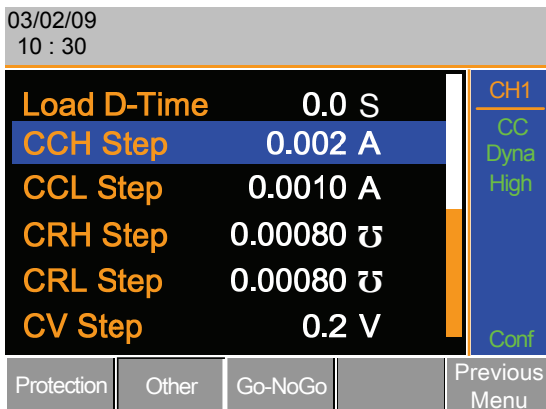

- Use the Selector knob to scroll down to highlight CCH Step.

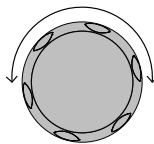

Note: CCH Step is off-screen when entering Other menu.

- Press the Selector knob to edit the selected setting, turn to change the setting.

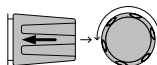

OR

Use the number pad to enter a number.



CCH Step **0.002** **A**

- Press the Selector knob or Enter to confirm selection.
- Repeat steps 2-4 to edit the step resolution of:



- CCL Step
- CRH Step
- CRL Step
- CV Step



Note

The Step resolution settings only apply to the active channel, other channels will not be affected.

Go/NoGo

Background Go/NoGo mode is used to set threshold limits. When a load is within the limit(s) it is considered to be “Go”, when the load has exceeded the limit it is considered to be “NoGo”.

Go/NoGo limits can be set as either absolute values (Entry Mode set to “Value”) or as a percentage offset from a nominal (Center) value (Entry Mode set to “Percent”).

Go/NoGo can be used in both high and low ranges, as well as CC, CV, and CR modes. The Go/NoGo status can be read using the rear Go/NoGo output.

A delay time can also be imposed for up to 1 second.



Note

Any Go/NoGo configuration only applies to the current channel with the same mode and range.

Parameters	Value	Percent
CC Mode	High: V	High: %
CR Mode	Low: V	Low: % Center: V
CV Mode	High: A Low: A	High: % Low: % Center: A
Delay Time	0.0~1.0 seconds	

Panel Operation Ensure the menu is in the Configuration menu. See page160.



Choose Absolute/ Percentage limits 1. Press (F3) Go-NoGo to access the Go/NoGo menu.



2. Use the selector knob to edit Entry Mode.

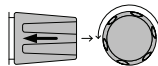

3. Choose Value for absolute limits or Percent for percentage offset limits.



Or



4. The menu changes according to the selection.

Value

Percent

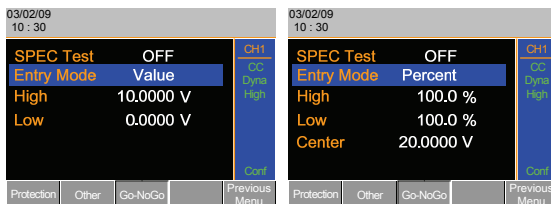

5. Use the Selector knob and number pad to edit Delay time, High, Low and Center (Percent mode only).

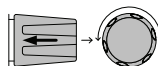

6. Press the selector knob or Enter to confirm each value.



Turn Go/NoGo
On/Off

7. Use the Selector knob to edit Spec Test.
8. Choose ON to turn on Go/NoGo.

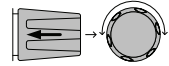

SPEC test ON

9. Choose OFF to turn off Go/NoGo.

SPEC test OFF

When SPEC test is set to ON, SPEC will be displayed in the Current Operation Channel Status panel.



Mainframe Configuration

The Mainframe Configuration chapter describes configuration settings that apply to all channels and general interface settings.

Mainframe Configuration	180
Accessing System Information	181
Accessing the Load Menu	182
Configuring the Date and Time	183
Adjusting the Speaker	184
Adjusting the display settings	185
Adjusting the Frame Control	187
Adjusting the Knob Control Type.....	188
Configuring Alarm Sound.....	190
Configuring Go/NoGo Alarm Sound ..	191
Adjusting Slave Knob Settings	192
View Language Settings	194

Accessing System Information

Background	The System Information displays the mainframe and load module(s) serial numbers.
Parameters	<p>MainFrame Ver: Mainframe firmware version and date (month/ day).</p> <p>PEL-200X SN: Mainframe Serial number.</p> <p>SlotX(Y)Ver: The version number of the Xth load module occupying the Xth slot with channel number Y.</p> <p>PEL-20XX SN: The serial number and module model of the Xth load module</p> <p>Y designates the first channel of each installed load module. For example if two dual channel load modules are installed, then Ch1&3 will be used for the firmware and serial number.</p>

- Panel operation
1. Press the Shift Key then the Help key to access the Utility menu/System Info menu.

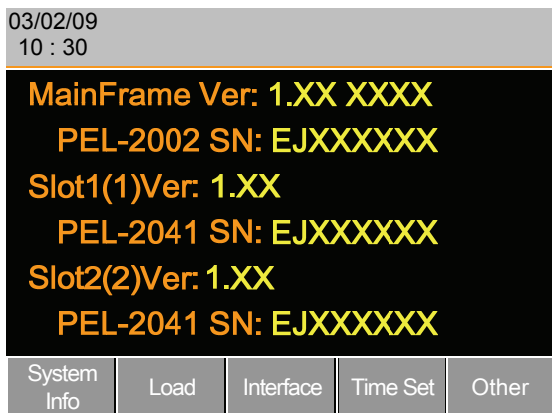
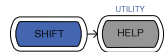

Accessing the Load Menu

Background The PEL series is able to automatically start loading from the last program or load setting.

If Auto Load On is set to Load, the last load setup used before the machine was reset will automatically start to load upon startup.

If Program is set as the Auto Load On configuration, the last program executed will start upon the next start up.

Parameters	Auto Load	ON/OFF
	Auto Load On	Load/Program

- Panel operation**
1. Press the Shift Key then the Help key to access the Utility menu.
 2. Press F2 (Load).

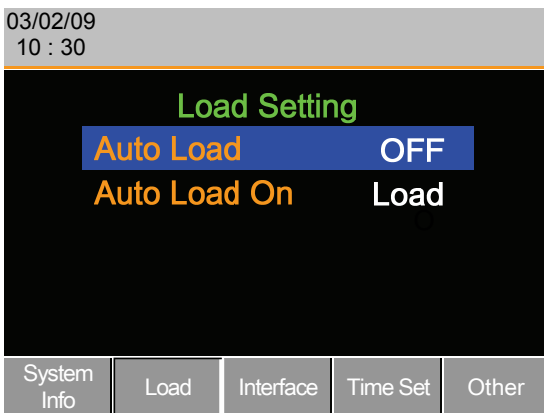
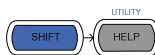

3. Press the Selector knob, then turn to choose Auto Load.

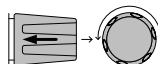

4. Press the Selector knob or Enter to confirm selection.
5. Scroll to Auto Load On and repeat the steps.

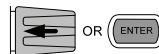

Configuring the Date and Time

Background The PEL series is able to display the time and date on the Mainframe Status panel, it is also used to tag files that are saved.

Time information is displayed on the top-left hand side.

Parameters	Month	Day
	Year	Hour (24 hour)
	Minute	

- Panel operation**
1. Press the Shift Key then the Help key to access the Utility menu.
 2. Press F4 (Time Set Menu) to access the Time Set Menu.

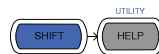

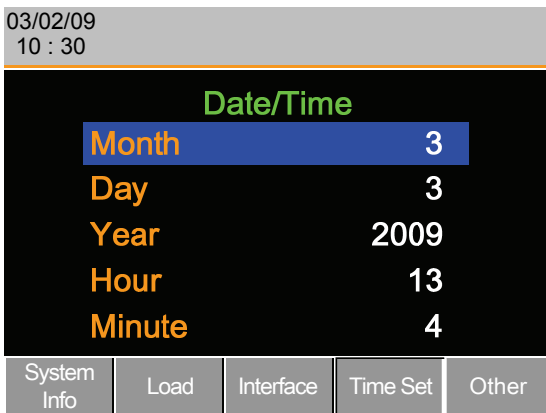

3. Use the Selector knob to highlight Month.
4. Press the Selector knob, then turn to increase or decrease the Month.
5. Press the Selector knob or Enter to confirm selection.
6. Repeat steps 3-5 for the Day, Year, Hour and Minute.

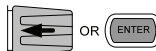
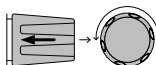
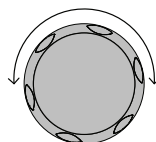

Adjusting the Speaker

Background The PEL series has an internal speaker for both the mainframe and load modules. The speaker function turns On/Off the sound for the UI (key presses and scrolling). The speaker setting will not alter the sound for protection alarms or Go/NoGo alarms.

Parameter Speaker ON/OFF

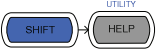
- Panel operation
1. Press the Shift Key then the Help key to access the Utility menu. 

2. Press F5 (Other Menu). 

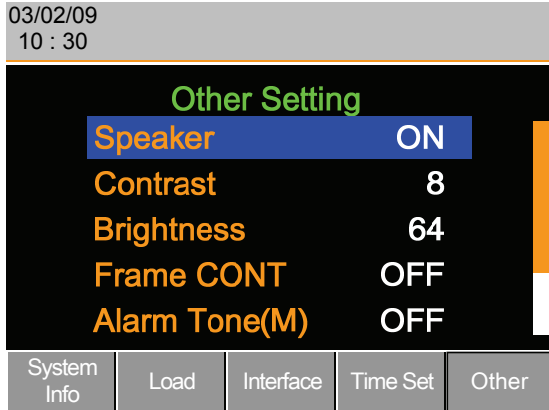

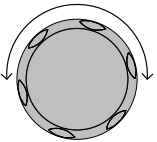
3. Use the Selector knob to highlight Speaker. 

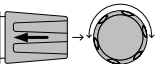
4. Press the Selector knob to edit Speaker, then turn to change from On to Off and vice versa. 



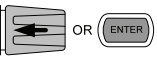

5. Press the Selector knob or Enter to confirm selection. 

Adjusting the display settings

Background The PEL series has a TFT LCD display. The display brightness and contrast can be controlled via the utility menu.

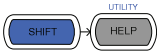
Parameters	Brightness	50~90	50(low)	90(bright)
	Contrast	3~13	3(low)	13(high)

- Panel operation
1. Press the Shift Key then the Help key to access the Utility menu. 
 2. Press F5 (Other Menu). 

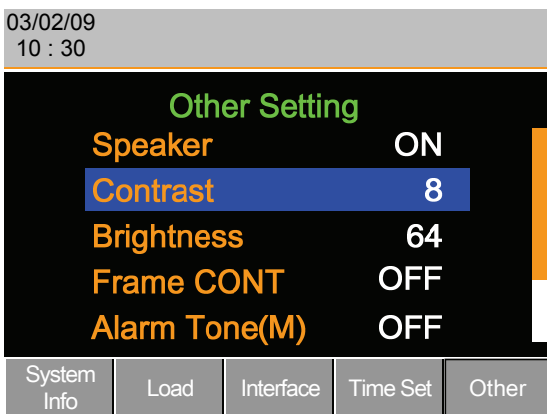

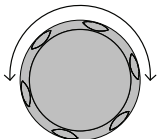
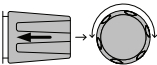
3. Use the Selector knob to highlight Contrast. 
4. Press the Selector knob to edit contrast, then turn to increase or decrease the value. 

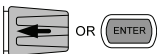

5. Press the Selector knob or Enter to confirm selection. 
6. Repeat steps 3-5 for the Brightness.

Adjusting the Frame Control

Background Frame control is used to control a number of different frame linked mainframes (slaves) with a master mainframe. For information on frame control, frame control interface and connection see pages 54 & 236.

- Panel operation**
1. Connect the mainframes using a frame link connection. Page 54.
 2. On the master mainframe, press the Shift Key then the Help key to access the Utility menu.
 3. Press F5 (Other Menu).

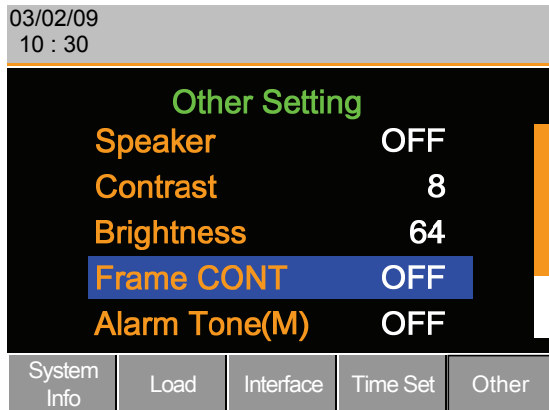
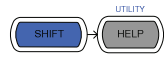

4. Use the Selector knob to highlight FrameCONT.

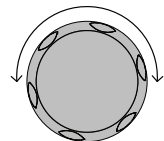

5. Press the Selector knob to edit, then turn to turn Frame CONT (frame control) ON or OFF.

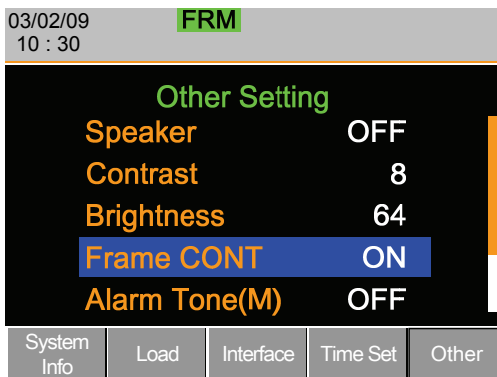
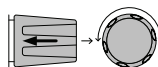

When Frame CONT is set to ON the mainframe will display FRM (Master) or FRS (Slave) on the top of the display.

6. Repeat the above steps for any connected slave mainframe units.

Frame control is now ready for both master and slave mainframes.

Adjusting the Knob Control Type

Background



The load module control knobs can be set to operate independently to the mainframe.

With the Knob type set to Updated, dependent operation is activated. Both the local (load module) selector knob and mainframe selector knob can change the resistance (CR mode), current (CC mode) and voltage (CV mode). Changes from local mode are updated on the mainframe and vice

versa.

With the Knob type set to Old, independent operation is activated. Local operation changes do not change the setting/values on the mainframe.

Parameter	Knob Type	Updated/Old
-----------	-----------	-------------

- | | | | |
|-----------------|----|---|---|
| Panel operation | 1. | Press the Shift Key then the Help key to access the Utility menu. |  →  |
| | 2. | Press F5 (Other Menu). |  |

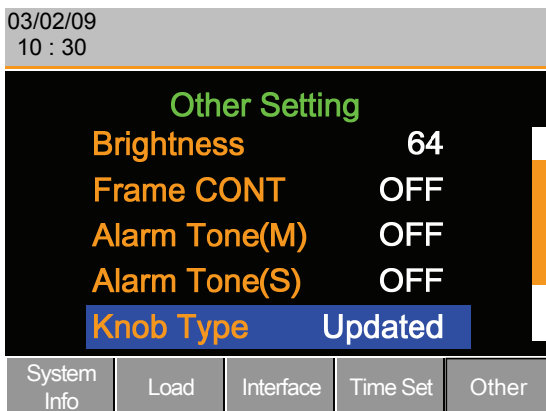

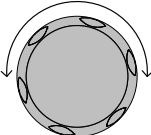
3. Use the Selector knob to move the cursor down to Knob Type (below the initial screen).
- 

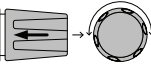
4. Press the Selector knob to highlight Knob Type, then turn to change to Old/Updated.
- 

Knob Type Updated

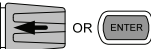
5. Press the Selector Knob or Enter to confirm selection.
- 

Configuring Alarm Sound

Background The PEL series has two different types of alarms, one located on the mainframe (Alarm Tone M) and one for each load module (Alarm Tone S).

Alarm Tone(M)/(S) can individually be set ON or OFF.

- Panel operation**
1. Press the Shift Key then the Help key to access the Utility menu.
 2. Press F5 (Other Menu).

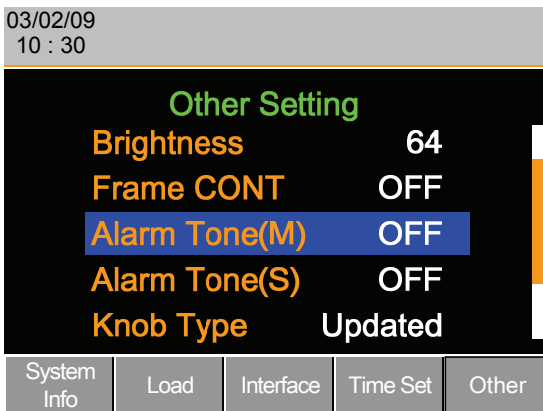
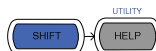

3. Use the selector knob to highlight Alarm Tone(M)

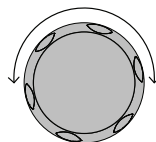

4. Press the Selector knob to select the master alarm (Alarm Tone(M)), turn to edit and press to confirm selection.

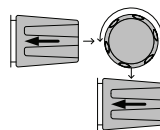

Alarm Tone(M) ON

5. Repeat the steps to edit the slave alarm (Alarm Tone(S)).

Configuring Go/NoGo Alarm Sound

Background When any Go/NoGo limits are tripped from any channel, a tone can be set as an alarm.

The Go-NoGo tone alarm settings apply to all channels.

Parameter Go/NoGo Tone ON/OFF

- Panel operation**
1. Press the Shift Key then the Help key to access the Utility menu.
 2. Press F5 (Other Menu).

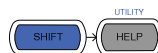

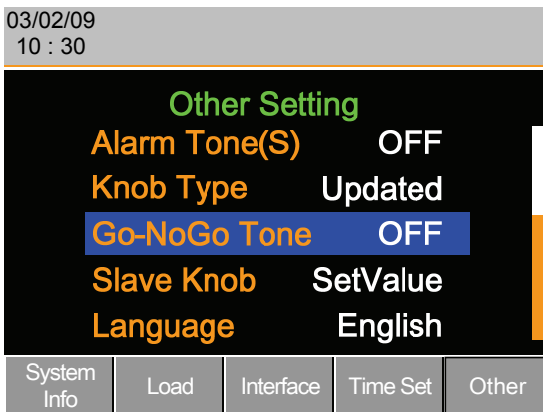

3. Use the Selector knob to move the cursor down to Go-NoGo Tone (below the initial screen).

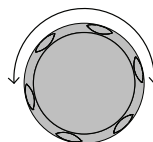

4. Press the Selector knob to highlight Go-NoGo Tone, then turn to change to ON/OFF.

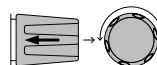

Go-NoGo Tone OFF

5. Press the Selector Knob or Enter to confirm selection.



Adjusting Slave Knob Settings

Background



Channel loads can be edited using the local load module or the Mainframe. When using the local load module selector knob (slave knob) to edit a load, the load module display can be set to two different types: SetValue and Measured.

When a load is ON, SetValue will always display the set value (A Value, B Value) on the local load

module display whilst “Measure” will show the actual measured value when editing the load. These settings apply to all channels.

The “Measure” setting can be temporarily disabled by pressing the local load module selector knob to display the “SetValue” instead of the “Measure” value in the local load module display.

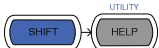

Parameter	Slave Knob	Measure/SetValue
-----------	------------	------------------

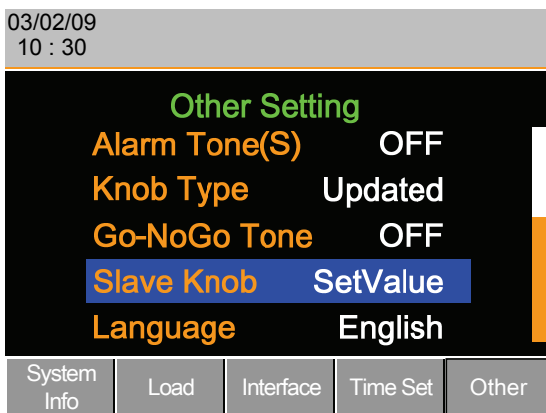
- | | | |
|-----------------|--|---|
| Panel operation | 1. Press the Shift Key then the Help key to access the Utility menu. |  |
| | 2. Press F5 (Other Menu). |  |

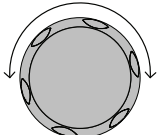
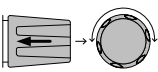



- | | |
|---|---|
| 3. Use the Selector knob to move the cursor down to Rotate Knob (below the initial screen). |  |
| 4. Press the Selector knob to highlight Rotate Knob, then turn to change to Measure/SetValue. |  |

Rotate Knob **SetValue**

5. Press the Selector Knob or Enter to confirm selection.  OR 

View Language Settings

Background The language settings can be viewed in the Utilities menu.

- Panel operation**
1. Press the Shift Key then the Help key to access the Utility menu.  
 2. Press F5 (Other Menu). 

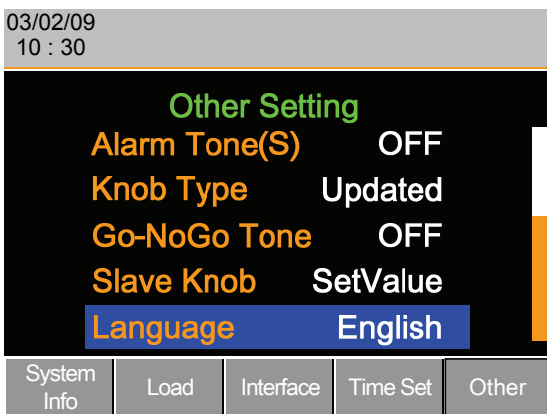

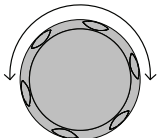
3. Use the Selector knob to move the cursor down to Language (below the initial screen). 

Interface Configuration (settings)

The Interface Configuration chapter describes configuration settings that apply when using the PEL-2000 with a remote connection. There are three interface options for remote control: RS232, GPIB and USB. Only one interface can be used at a time. For more details about remote control and interface connections, see the Interface section on page 232.



Interface Configuration (settings).....	195
Configuring RS232 Connection	196
Configuring the GPIB Address	198
Configuring USB Remote Connection.	199

Configuring RS232 Connection

Background When using RS232 a number of parameters need to be set. These include Baud rate, Stop Bit and Parity. When setting RS232 parameters, ensure they match that of the host machine.

Parameters

Baud Rate	2400/4800/9600/19200/38400
Stop Bit	1~2
Parity	None/Odd/Even

- Panel operation**
1. Press the Shift Key then the Help key to access the Utility menu.  
 2. Press F3(Interface Menu). 

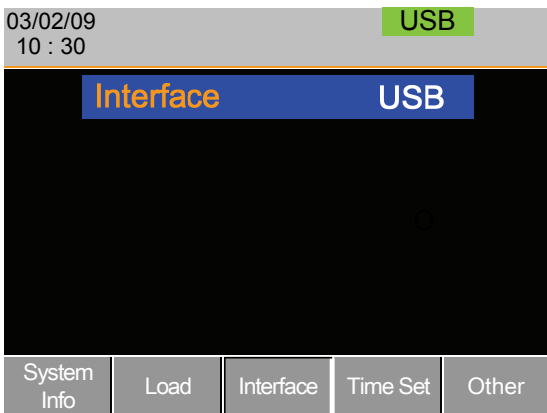

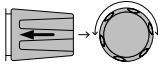
3. If the Interface mode is not RS232, use the Selector knob to edit Interface. 
4. Choose RS232.

Interface **RS232**

5. Press the Selector knob to confirm.



6. The RS232 Menu appears.

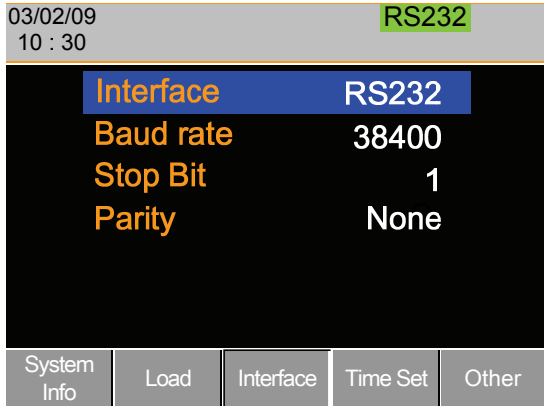

7. Use the Selector knob to edit Baud rate, Stop Bit and Parity.

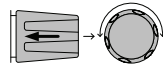



 **Note**

The Baud Rate, Stop Bit and Parity must match that of the host machine.

Configuring the GPIB Address

Background When using GPIB, an address must be specified.

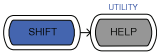
Parameters Address 01~30

- Panel operation**
1. Press the Shift Key then the Help key to access the Utility menu. 
 2. Press F3(Interface Menu). 

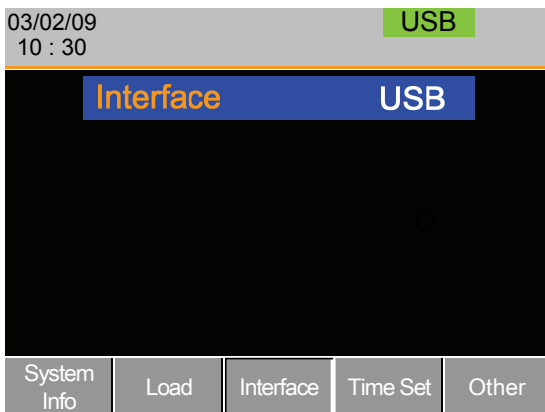

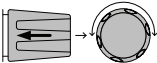

3. If the Interface mode is not GPIB, use the Selector knob to edit Interface. 
4. Choose GPIB.

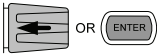

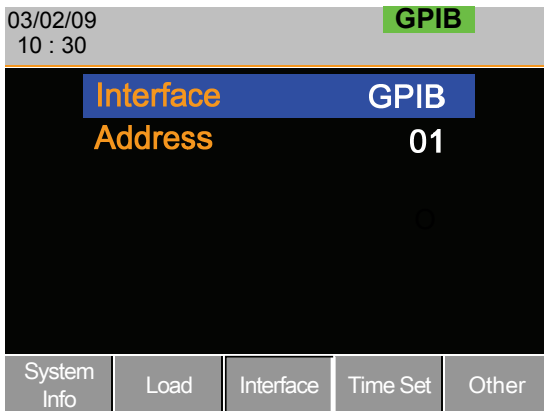
5. Press the Selector knob or Enter to confirm selection. 
6. The GPIB menu appears.



7. Use the selector knob to edit the GPIB address.  OR 





Note

The GPIB Address must match that of the host machine.

Configuring USB Remote Connection

Background Of the three interface options, USB is the easiest to use.

Panel operation 1. Press the Shift Key then the Help key to access the Utility menu.  → 

2. Press F3(Interface Menu). 

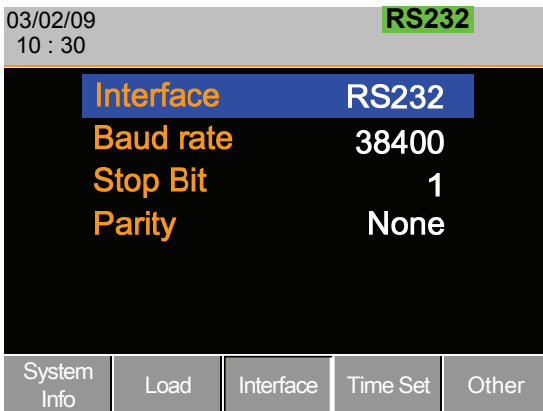

3. If the Interface mode is not USB, use the Selector knob to edit Interface.

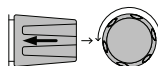

4. Choose USB.



5. Press the Selector knob to confirm.

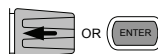

6. The Interface will become USB.

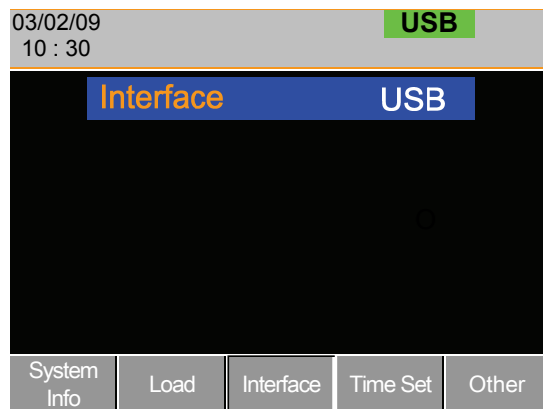

Save / Recall

Save / Recall	201
Saving/Recalling Channels.....	202
Saving/Recalling Preset memory.....	204
Saving/Recalling Setup Memory	206
Setting the Default USB Path/File	208
Saving Setups to USB Memory.....	213
Saving/Recalling Memory Data to USB.....	216
Saving/Recalling Presets to USB.....	220
Saving/Recalling Sequences to USB.....	224
Quick Preset Recall/Save	228
Recall Setup Memory (Frame link).	229
Recall Preset Memory (Frame link)	230
Recall Factory Defaults.....	231

Saving/Recalling Channels

Background The PEL 2000 series can save data for up to 120 different channel configurations. Each channel is represented by 120 memory slots using the onboard memory.

Memory is used in program sequences or for individual channel setups. For further details on memory, see page 89.

Panel operation 1. Press the File key.



2. Press F1 repeatedly until the Media Memory menu appears.

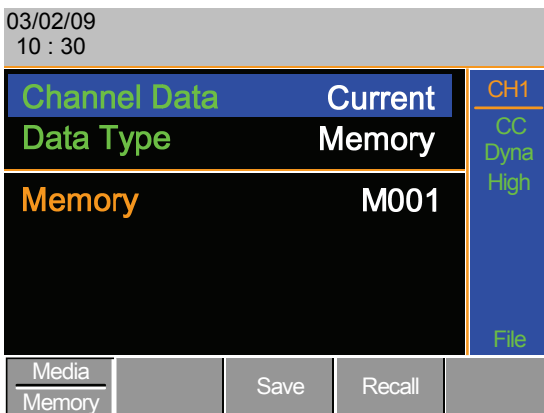
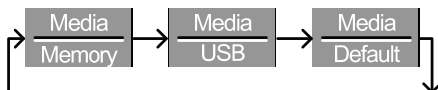

3. Use the Selector Knob to edit Channel Data and Data Type.

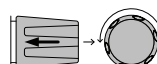

4. Choose Current and Memory.

Channel Data	Current
Data Type	Memory

5. Press the Selector knob to edit Memory (M001-M120)

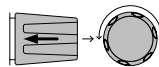

OR

Use the number pad to enter a number.

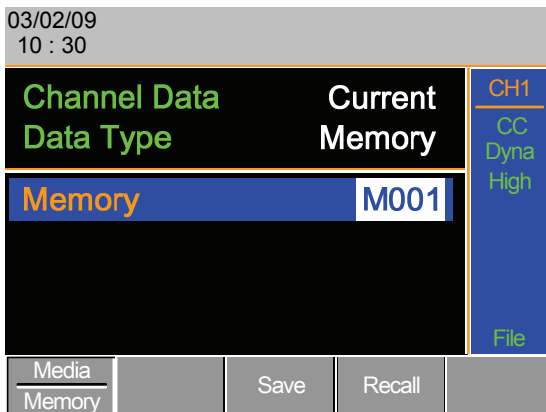

6. Press F3 to Save or F4 to Recall the memory settings.

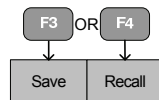

7. A message will indicate when a save has been successful

Memory No 001 Save OK



Note

The display will revert to the channel menu after recalling memory. Remember the memory is only saved/recalled for the current channel.

Saving/Recalling Preset memory

Background The PEL 2000 series can store up to 10 presets for each channel. The presets can be saved or recalled either individually for each channel (Channel Data: Current) or at the same time (Channel Data: All), using the All option.

For further details on memory, see page 89.

Panel operation 1. Press the File key.



2. Press F1 repeatedly until the Media Memory menu appears.

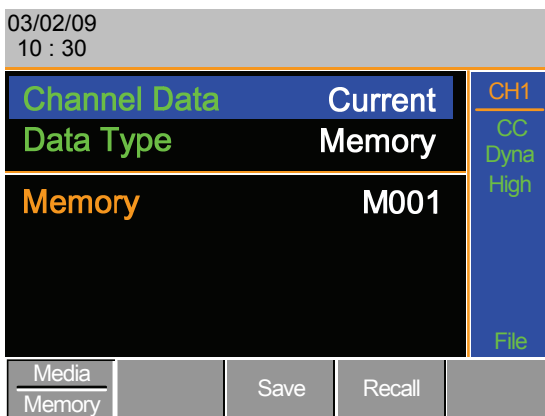

3. Use the Selector Knob to edit Channel Data and Data Type.

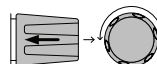

4. To save or recall only the active channel, choose Current and Preset. To save or recall all the presets choose All and Preset.

Save / Recall
Current Channel

Channel Data	Current
Data Type	Preset

Save / Recall All
Channels

Channel Data	All
Data Type	Preset

- Press the Selector knob to edit Preset (P0-P9)

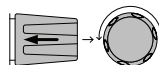

OR

Use the number pad to enter a number.

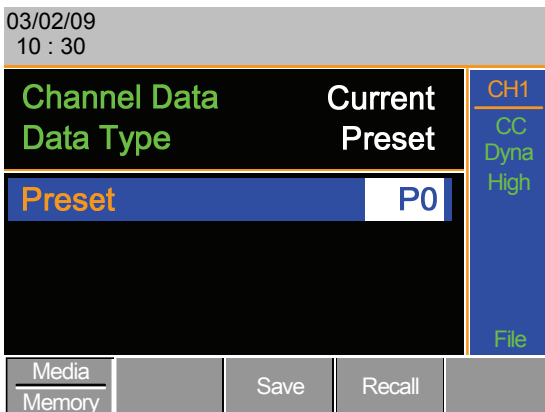

- Press F3 to Save or F4 to Recall the Presets.

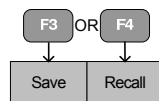

- A message will be displayed when the save is complete.

Preset P0 Save OK



Note

The display will revert to the channel menu after recalling memory.

Saving/Recalling Setup Memory

Background The PEL 2000 series can store up to 4 different setups using the onboard memory. Each setup can be saved from the file menu. Using Setup Memory, each channel will be saved. For further details on memory, see page 89.

Panel operation 1. Press the File key.

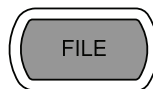

2. Press F1 repeatedly until the Media Memory menu appears.

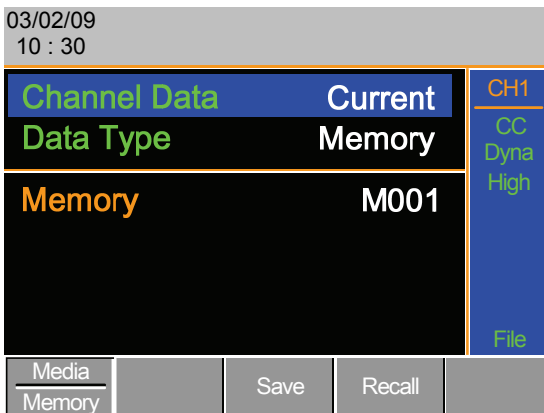
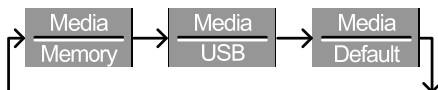

3. Use the Selector Knob to edit Channel Data and Data Type.

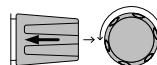

4. Choose All and Setup.

Channel Data	All
Data Type	Setup

5. Press the Selector knob to edit Setup Memory (1~4)

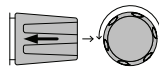

OR

Use the number pad to enter a number.

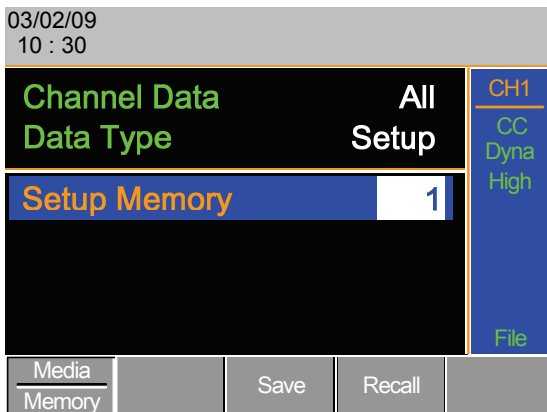

6. Press F3 to Save or F4 to Recall the Setup Memory.

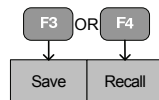





7. A message will be displayed when the save/recall is complete.

Setup Memory 1 Save OK

Setup Memory 1 Recall OK

Setting the Default USB Path/File

Background When saving files to a USB memory stick the files will be saved into the root directory if a file path has not been set.

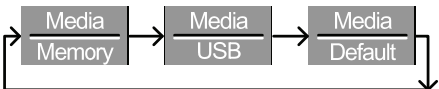
- Panel operation**
1. Insert a USB flash drive into the front panel USB slot.  
 2. Press the File key. 
 3. Press F1 repeatedly until the Media USB menu appears. 
- 

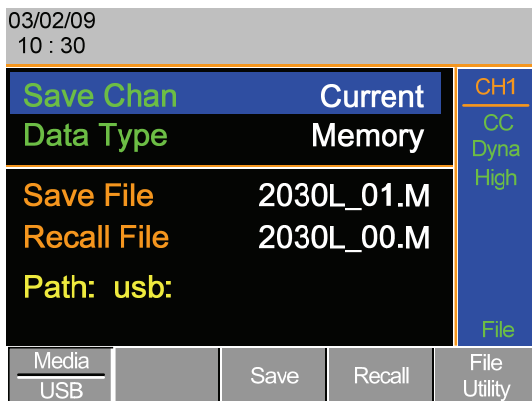

4. Press F5 (File Utility). 

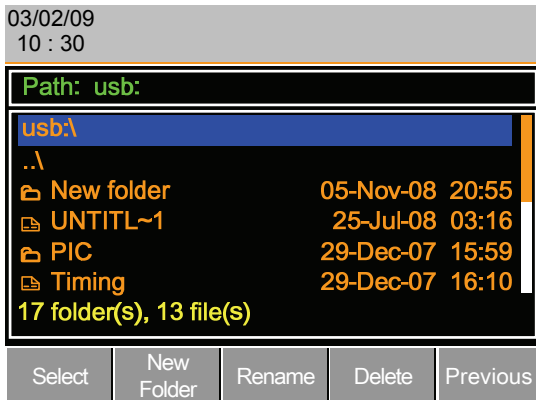

The top section (window) shows the current USB path.

There are 5 options:

- **Select;** Selects the current USB path as the default file path to save. (Step 5)
- **New Folder;** Creates a new folder (Step 7)
- **Rename;** Renames the current folder/path (Step 13)
- **Delete;** deletes the current file/path name. (Step 20)

Select Default Path

5. Use the Selector knob to highlight the new path directory

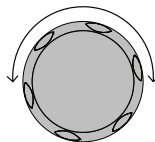

6. Press F1(Select) to select the new default directory path.



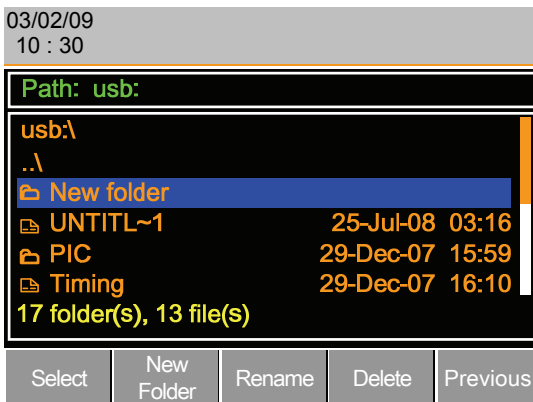

The new path will be shown in upper Path box in green.

Path: usbNew folder

Create New Folder

- To create a new directory, Press F2(New Folder)

F2

The On-Screen keyboard (OSK) appears. The directory has an 8 character size limit.

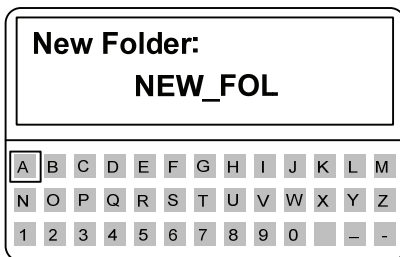

- Use the Selector knob to scroll left and right through the keys.

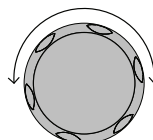

9. When a key is highlighted use the selector knob, F1 or Enter to confirm a key entry.

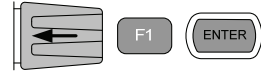

10. Use F2 (Back Space) to delete any previous entries/mistakes.



11. Press F3 (Save) to save the directory name.



12. Press F5 (Previous menu) to continue to the previous menus



Rename Folder

13. Use the Selector knob to highlight the file/ directory that needs to be renamed.

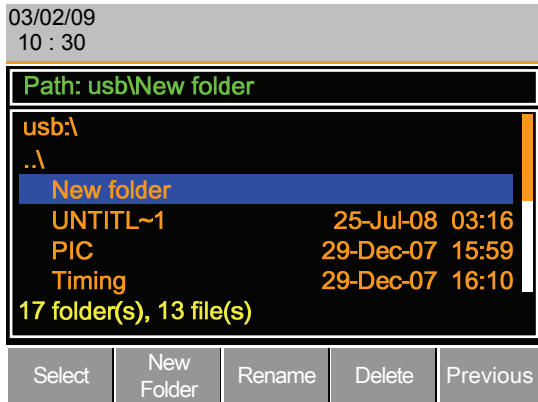
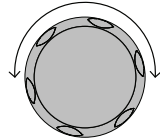

14. Press F3(Rename)



The On Screen Keyboard appears



15. Use the Selector knob to scroll left and right through the keys.

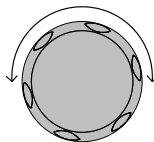

16. When a key is highlighted use the selector knob, F1 or Enter to confirm a key entry.

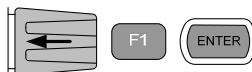

17. Use F2 (Back Space) to delete any previous entries/mistakes.



18. Press F3 (Save) to save the directory name.



19. Press F5 (Previous menu) to continue to the previous menus



-
- Delete File Name 20. Use the Selector knob to highlight a file/directory.

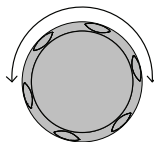

21. Press (F4) delete.



22. To confirm deletion, press F4 again.

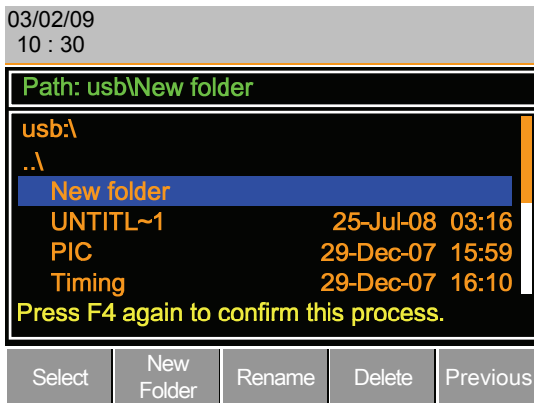



Saving Setups to USB Memory

Background Setup data contains all the channel data including Memory, Presets and Program Sequences.

There are four setups in internal memory. When saving to USB, all four setups will be saved. Conversely, when recalled, all four setups will be recalled to main memory.

The file extension *.S is used for Setup data only.

Parameters	Save File	200X0_XX.S
	Update File	200X0_XX.S

- Panel operation**
1. Insert a USB flash drive into the front panel USB slot.  
 2. Ensure the USB path has been set. Page 208.

3. Press the File key.



4. Press F1 repeatedly until the Media USB menu appears.

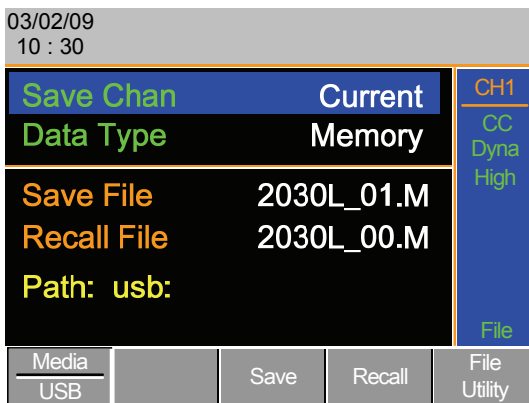
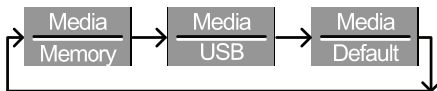

5. Use the Selector Knob to edit Save Chan and Data Type.
6. Choose All and Setup.

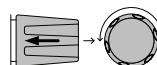

03/02/09 10 : 30				
Save Chan All			CH1	
Data Type Setup			CC Dyna High	
Save File		20040_01.S		
Recall File		20040_00.S		
Path: usb:				
Media		Save	Recall	File Utility
USB				

The screen will update to only show Setup files (*.S) that are available to save/recall in the default path directory.

Save/ Recall
Setups to USB

- Use the Selector Knob to edit Save File or Recall File. Rotating the selector knob will scroll through all the available setup files (*.S).
- Choose a file name (20XXX_XX.S).
- Press F3 (Save) to save the setup data or F4 (Recall) to recall the setup data.
- A screen message will appear when the save/recall has completed.

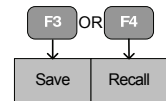
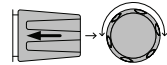

20040_01.S Save Ok

20040_00.S Recall Ok



Note

Setups can only be saved if they have been saved to internal memory first. For details on how to save to internal memory see page 204.

Saving/Recalling Memory Data to USB

Background There are two options to save or recall Memory data to a USB flash drive:

Save Chan Current: Saves the active Channel's Memory data(M001~M120) into the default file path (20XXX_XX.M).



Save Chan All: Every channel's Memory data (CH1 M001~120 ~ CH8 M001~M120) will be saved into a directory (ALL00XX) as separate files for each channel (P0X0X_C1.M ~ P0X0X_C8.M).

Recall File: Recalls the selected file to the active channel's Memory (MXXX). It is not possible to update all the channels at once, only one channel at a time can be recalled.

The file extension *.M is used for Memory data only.

For more information about the file structures see page 89.

Parameters	Save All Ch Directory ALL0000 ~ ALL0099 File: P0X0X_CX.M
	Save File File: 20XXX_XX.M
	Update File File: 20XXX_XX.M

- Panel operation**
1. Insert a USB flash drive into the   front panel USB slot.
 2. Ensure the USB path has been Page 208. set.

3. Press the File key.



4. Press F1 repeatedly until the Media USB menu appears.

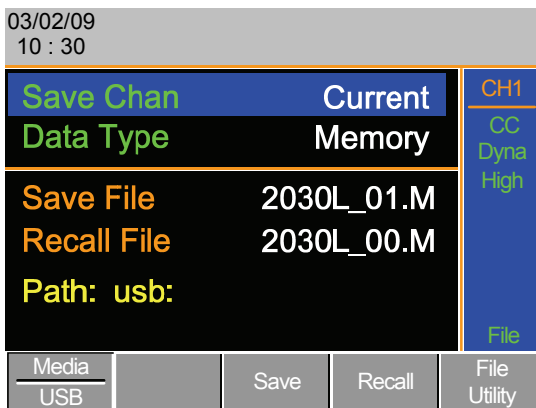
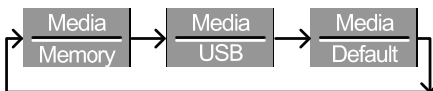

Save all Channels

5. Use the Selector knob to edit Save Chan and Data Type.
6. Choose All, and Memory

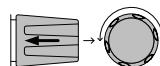

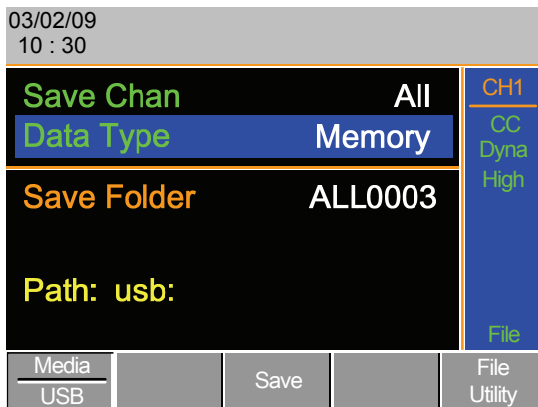

The screen updates to show Save Folder. Note it is not possible to recall all channels at once, only save.

7. Use the Selector Knob to edit Save Folder.

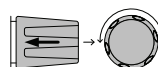

8. Choose a directory name (ALL0000~ALL0099).

Save Folder ALL0003



Note

Any used directories will not be available. It is not possible to over-write older directories. They must be deleted first.

9. Press F3 (Save)



10. A screen message will be displayed when complete.

ALL003 Save Ok

Save /Recall File

11. Use the Selector Knob to edit Save Chan and Data Type.

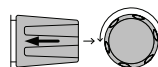

12. Choose Current and Memory.

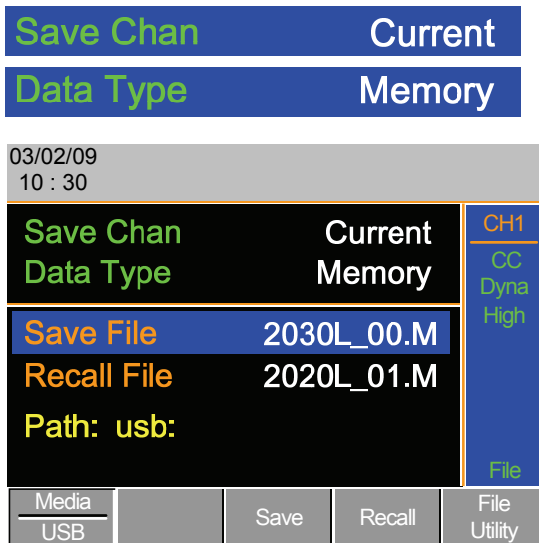

13. Use the selector knob to edit Save or Recall File.
14. Choose a file name.
15. Press F3(Save) to save or F4(Recall) to recall the current channel. (MXXX)

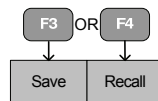

16. A save or recall message will be displayed when complete.

2030L_01.M Save Ok



Note

Remember only data that has been saved to internal memory will be saved to USB. Only the active channel will be saved.

If you try to recall data that originated from a different load module than the active channel, an error message will appear. The filename must reflect the active channel's load module type.

Machine Type Error

Saving/Recalling Presets to USB

Background There are two options to save or recall Channel Presets to a USB flash drive:

Save Chan Current: Saves the active Channel's Presets (P0~P9) into the default file path (20XXX_XX.P).



Save Chan All: Every channel's Presets (CH1 P0~P9 ~ CH8 P0~P9) will be saved into a directory (ALL00XX) as separate files for each channel (P0X0X_C1.P ~ P0X0X_C8.P)

Recall: Recalls the selected file to the active channel's Presets (P0~P9). It is not possible to update all the channels at once, only one channel at a time can be recalled.

The file extension *.P is used for channel Presets only.

For more information about the file structures see page 89.

Parameter	Save All Ch Directory: ALL0000 ~ ALL0099 File: P0X0X_CX.P
	Save File File: 20XXX_XX.P
	Update File File: 20XXX_XX.P

- Panel operation**
1. Insert a USB flash drive into the   front panel USB slot.
 2. Ensure the USB path has been Page 208. set.

3. Press the File key.



4. Press F1 repeatedly until the Media USB menu appears.

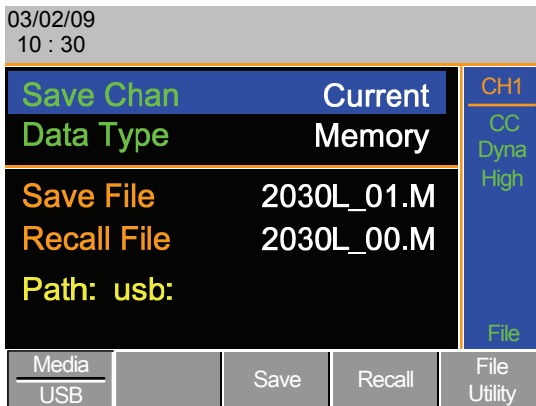
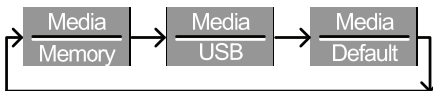

Save all Channel Presets

5. Use the Selector knob to edit Save Chan and Data Type.
6. Choose All, and Preset

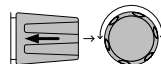

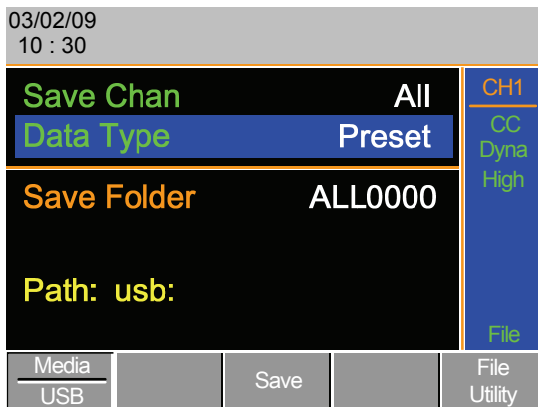

The screen updates to show Save Folder. Note it is not possible to recall all presets at once, only save.

7. Use the Selector Knob to edit Save Folder.

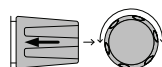

8. Choose a directory name (ALL0000~ALL0099).

Save Folder ALL0000



Note

Any used directories will not be available. It is not possible to over- write older directories. They must be deleted first.

9. Press F3 (Save)



10. A screen message will be displayed when the save is complete.

ALL0001 Save Ok

Save/Recall Preset (current channel)

11. Use the Selector Knob to edit Save Chan and Data Type.

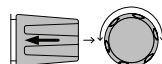

12. Choose Current and Preset.

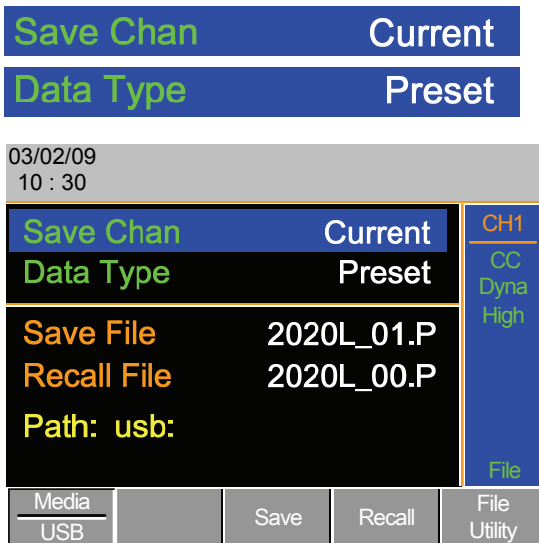

13. Use the selector knob to edit Save File or Recall file.

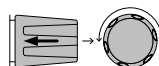

14. Choose a file name.

15. Press F3 (Save) to save or F4 (Recall) to recall the Channel Presets. (PXX)

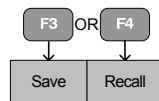

16. A message will be displayed when the save or recall has completed.

2020L_01.P Save Ok



Note

Remember only data that has been saved to internal memory will be saved to USB. Only the active channel presets will be saved.

If you try to recall data that originated from a different load module than the active channel, an error message will appear. The filename must reflect the active channel's load module type.

Saving/Recalling Sequences to USB

Background There are two options to save or recall Sequences to a USB flash drive. Sequences can either be saved from all channels or from the current channel only.

Save All: Every channels' sequences will be saved into a directory (ALL00XX) as separate files for each channel (20XXX_C1.A~ 20XXX_C8.A).



Save Current: The current channel's sequence will be saved into the default directory (20XXX_XX.A)

Recall: Sequences can only be recalled for the current channel. It is not possible to recall all channels' Sequences at once.

The file extension *.A is used for Sequences only.

For more information about the file structures see page 89.

Parameters	Save All SEQ	Directory: ALL0000 ~ ALL0099 File: 20XXX_C1.A
	Save Current SEQ	File: 20XXX_XX.A
	Recall Current SEQ	File: 20XXX_XX.A

- Panel operation**
1. Insert a USB flash drive into the front panel USB slot.  
 2. Ensure the USB path has been set. Page 208.
 3. Press the File key. 

4. Press F1 repeatedly until the Media USB menu appears.

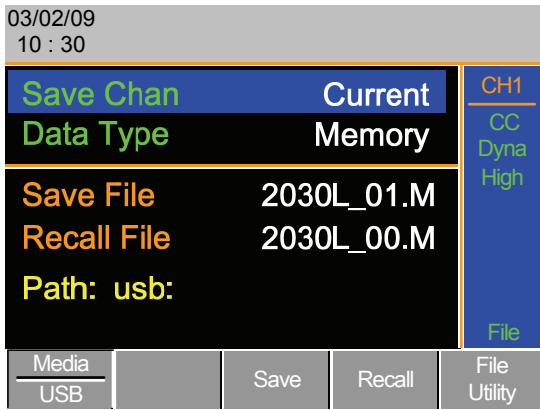
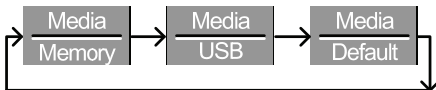

Save all Channel
SEQ

5. Use the Selector knob to edit Save Chan and Data Type.
6. Choose All, and SEQ

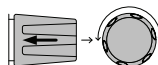

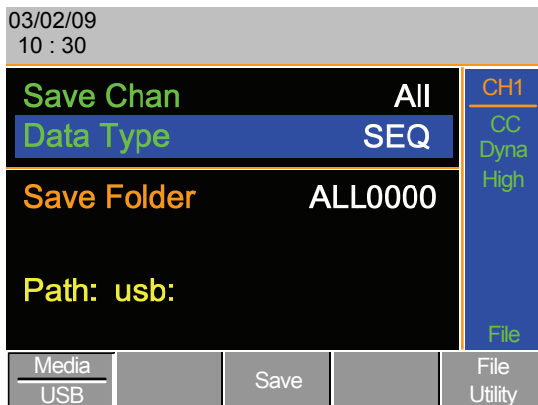

The screen updates to show Save Folder. Note it is not possible to recall all SEQ data at once, only save.

7. Use the Selector Knob to edit Save Folder.

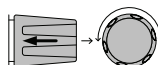

8. Choose a directory name (ALL0000~ALL0099).



Any used directories will not be available. It is not possible to over-write older directories. They must be deleted first.

9. Press F3 (Save)



10. A screen message will be displayed when saving.

Save All Chan in ALL000

Save/Recall SEQ (current channel)

11. Use the Selector Knob to edit Save Chan and Data Type.

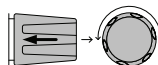

12. Choose Current and SEQ.

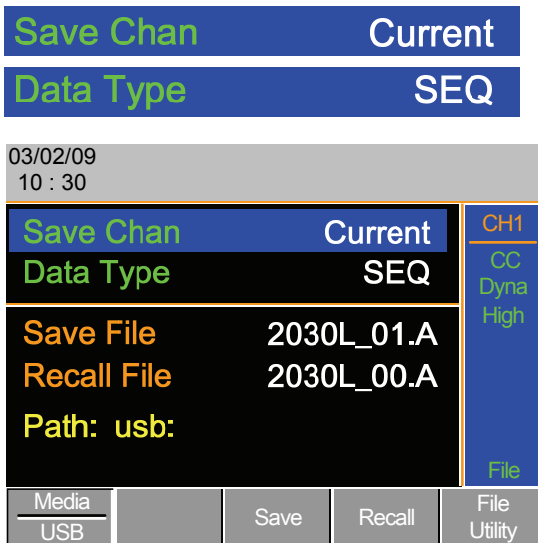

13. Use the selector knob to edit Save File or Recall File.
14. Choose a file name.
15. Press F3 (Save) to save or F4 (Recall) to recall the current channel's sequence.

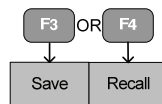

16. A message will be displayed when the file is saved/recalled.

Save in 2030L_01.A



Note

Remember a sequence must first be saved to (internal) memory before it can be saved to USB.

If you try to recall data that originated from a different load module than the active channel, an error message will appear. The filename must reflect the active channel's load module type.

Quick Preset Recall/Save

Background The PEL 2000 series mainframes have up to 10 Channel Presets (P0~P9). Quick recalling or saving presets will only be applicable to the active channel. For example, P1 on CH1 is not the same as P1 on CH2.

Parameter Presets P0 ~ P9 (current channel)

Panel Operation

1. Remove any USB devices from the front panel.
2. Select the channel you want to save Channel Presets to. Page 119.

Save Current Channel Preset

3. To save a Channel Preset, press the Preset key and hold one of the number keys (0-9) for a short time until a beep is heard.



0 = P0

1 = P1 etc.

Save All Channel Presets

4. To save All Channel Presets, press the Shift key, the Preset key and hold one of the number keys (0-9) for a short time until a beep is heard.

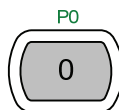
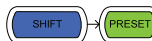

0 = P0

5. 1 = P1 etc.

6. Press the Preset key again to deactivate it.

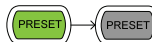

The Preset will be saved to the one of 10 presets depending on the number pressed.

Recall Current Channel Preset 7. Press the Preset key and one of the number keys.



0 = P0
1 = P0 etc.

Recall All Channel Presets 8. Press the Shift key, the Preset key and one of the number keys.

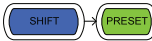

0 = P0

9. 1 = P0 etc.

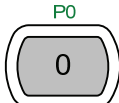

10. Press the Preset key again to deactivate it.



Only the active channel's Channel preset will be recalled.

Recall Setup Memory (Frame link).

Background A master mainframe can command all mainframes (master and slave) to recall setup memory from their internal memory. No setup data will be recalled from the master mainframe to the slave units.

Parameter Setup memory 1~4.

Panel Operation 1. On the Master mainframe, follow the procedure for recalling setup memory for all channels.

Page 206

All mainframes will update setup memory upon recall

Recall Preset Memory (Frame link)

Background A master mainframe can command all units to recall preset memory from their internal memory. Only the first three preset memories (P0~P2) can be recalled.

Channel presets can be recalled via the file menu or using the quick recall feature using the number pad.

Parameters Presets P0 ~ P2 (current channel)

Panel Operation: 1. Remove any USB devices from the front panel.

Quick Keys

2. On the master mainframe, press the Shift and Preset key.

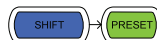

3. Press one of the number keys (0-2).
 0 = P0
 1 = P1 etc

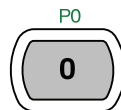

The screen will flash momentarily when the presets are recalled.

Panel Operation: 4. On the master mainframe follow the procedure to recall preset memory for all channels.

File menu

Page 204

The screen will flash momentarily when the presets are recalled.

Recall Factory Defaults

Background The Factory defaults can be recalled at any time. For details on the factory defaults please see the default settings in the appendix, page 251

Panel Operation 1. Press the File key.



2. Press F1 repeatedly until the Media Default menu appears.



3. Press Recall (F4) to recall the factory default settings.



4. Wait a short time for the settings to be recalled.

I NTERFACE

The Interface chapter details the pin configuration of the RS232, GPIB, Frame Link, Channel Control and Go/NoGo interfaces.

Interface Configuration	233
Configure RS-232C interface.....	233
Configure GPIB interface.....	234
Configure Channel Control interface ..	235
Configure Frame Link Interface	236
Configure Go/NoGo Interface	239
USB Interface Connection	240

Interface Configuration

Configure RS-232C interface

RS-232C configuration	Connector	DB-9, Male
	Baud rate	9600
	Parity	None
	Data bit	8
	Stop bit	1

Connect the RS-232C cable (GW Instek part no. GTL-232) to the rear panel port: DB-9 male connector.

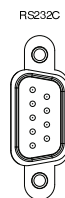

Pin assignment

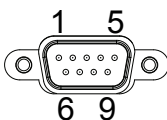

- 2: RxD (Receive data)
- 3: TxD (Transmit data)
- 5: GND
- 1, 4, 6, 7, 8, 9: No connection

PC connection

Use the Null Modem connection as shown in the diagram below.

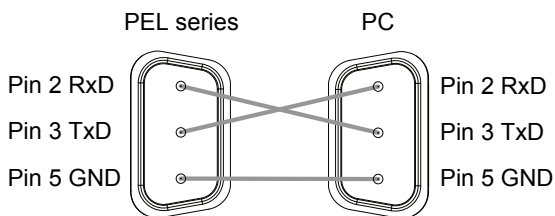

Configure GPIB interface

Connection Connect the GPIB cable to the rear panel port: 24-pin female connector. 

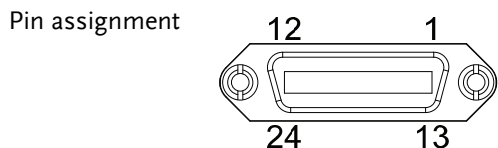

Pin1	Data line 1	Pin13	Data line 5
Pin2	Data line 2	Pin14	Data line 6
Pin3	Data line 3	Pin15	Data line 7
Pin4	Data line 4	Pin16	Data line 8
Pin5	EOI	Pin17	REN
Pin6	DAV	Pin18	Ground
Pin7	NRFD	Pin19	Ground
Pin8	NDAC	Pin20	Ground
Pin9	IFC	Pin21	Ground
Pin10	SRQ	Pin22	Ground
Pin11	ATN	Pin23	Ground
Pin12	Shield (screen)	Pin24	Signal ground

- GPIB constraints**
- Maximum 15 devices altogether, 20m cable length, 2m between each device
 - At least 2/3 of the devices turned On
 - No loop or parallel connection

Configure Channel Control interface

Channel control configuration	Connector	Screwless connector.
	Wire Gauge	22-28 AWG (24 AWG recommended).
	Wire connection	10 mm strip gauge for connection.

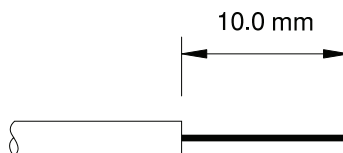

Input 0-10V.

Pin Assignment



1	GND	Negative potential of the load input terminal.
2	I MON (OUTPUT)	Load input current monitor; where 0V = 0% of input current and 10V = 100% of input current.
3	V MON (OUTPUT)	Load input voltage monitor; where 0V = 0% of input voltage and 10V = 100% of input voltage.
4	Ext Voltage ref (INPUT)	External voltage reference; Where 0V=0% of rating voltage/current and 10V = 100% of rating voltage/current. The external voltage reference is for CC and CV mode.

5 Load On	Load On Input. Load on = Active low, 0-1V Load off = Active high, 4-5V. (Using the + load polarity in conjunction with a 10kΩ pull up resistor)
6 +15V	Internal power output. Max 50mA.

Channel Control Interface Constraints	Mode/Range	Mode and Range configuration is only selected via the front panel.
---------------------------------------	------------	--

Configure Frame Link Interface

Connection Connect the Frame link cable (MIL 20 pin connector) to the rear panel port: 20-pin male connector.

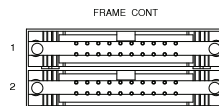

Pin assignment
(Frame link connector 1)

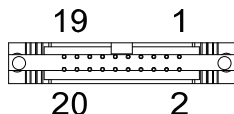

Pin1	A	Recall Preset memory 0 (All channels)
Pin2	B	Recall Preset memory 1 (All channels)
Pin3	C	Recall Preset memory 2 (All channels)
Pin4	TRIG_OUT	Trigger out
Pin5	MEM_0	Recall Setup memory 1 (All channels)
Pin6	MEM_1	Recall Setup memory 2 (All channels)

Pin7	MEM_2	Recall Setup memory 3 (All channels)
Pin8	MEM_3	Recall Setup memory 4 (All channels)
Pin9	Enable	Enable Load (On/Off), recall Preset memory (0- 3) and Setup memory (1- 4)
Pin10	Load On/Off	
Pin11	Not used	
Pin12	Not used	
Pin13	Not used	
Pin14	Not used	
Pin15	Load Status	Output, load on status.
Pin16	Alarm Status	Output alarm activated.
Pin17	+5V	Output, 5V+, 100mA.
Pin18	N.C	No connection.
Pin19	GND	Ground
Pin20	GND	Ground

Pin assignment
(Frame link
connector 2)

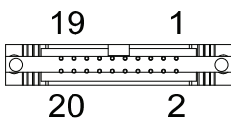

Pin1	Sync._A	Sync signal, Recall Preset memory 0 (All channels)
Pin2	Sync._B	Sync signal, Recall Preset memory 1 (All channels)
Pin3	Sync._C	Sync signal, Recall Preset memory 2 (All channels)
Pin4	AUX	Reserved

Pin5	Sync._MEM_0	Sync signal, Recall Setup memory 1 (All channels)
Pin6	Sync._MEM_1	Sync signal, Recall Setup memory 2 (All channels)
Pin7	Sync._MEM_2	Sync signal, Recall Setup memory 3 (All channels)
Pin8	Sync._MEM_3	Sync signal, Recall Setup memory 4 (All channels)
Pin9	Sync._Enable	Sync signal, Enable Load (On/Off), recall Preset memory (0-3) and Setup memory (1-4)
Pin10	Sync._Load On/Off	Sync signal, Load On/Off
Pin11	Not used	
Pin12	Not used	
Pin13	Not used	
Pin14	Not used	
Pin15	Load Status	Sync signal, Output, load on status.
Pin16	Alarm Status	Sync signal, Output alarm activated.
Pin17	N.C	No connection
Pin18	+5V	+5V, 100mA
Pin19	GND	Ground
Pin20	GND	Ground

- | | |
|------------------------|---|
| Connection | <ul style="list-style-type: none"> • Input: active low (0-1V), active high (4-5V) • Inputs (5V, 10kΩ pull-up resistor) • Open collector outputs (Load status, Alarm Status, +5V) maximum 30VDC with 1.1V saturation voltage (100mA). • When enable is on (active low), the following is disabled from the mainframe: activating loads and recalling preset or setup memory. |
| Frame Link constraints | <ul style="list-style-type: none"> • Maximum 5 (1 master + 4 slave units) devices can be linked altogether with a maximum cable length of 30cm for each cable. • All the connected devices must be turned on. • No loop or parallel connections |

Configure Go/NoGo Interface

Connection Use a DSUB (DB-15 Female) connector to connect to the Go/NoGo port.

The Go/NoGo port is an output only port.

GO /NG OUTPUT

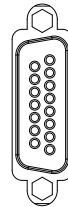

Pin assignment

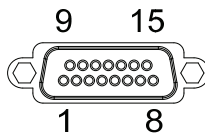

Pin1	Ch1_GO/NG	Pin9	Ch5_GO/NG
Pin2	GND	Pin10	GND
Pin3	Ch2_GO/NG	Pin11	Ch6_GO/NG
Pin4	GND	Pin12	GND

Pin5	Ch3_GO/NG	Pin13	Ch7_GO/NG
Pin6	GND	Pin14	GND
Pin7	Ch4_GO/NG	Pin15	Ch8_GO/NG
Pin8	GO/NG_Enable		

Connection Type Open collector output maximum 30VDC with 1.1V saturation voltage (100mA).

30 V DC (high)	Pass (Go) or SPEC Test: OFF
1.1 V DC (low)	Fail (NoGo)

USB Interface Connection

Connection For USB remote connection, use the USB-B port on the mainframe rear panel.



F AQ

Q1. The load voltage indicated on the load module is below expected.

A1. Ensure the load leads are as short as possible, twisted and use the appropriate wire gauge. Ensure that voltage sense is used, this can help alleviate the voltage drop across the load the leads.

Q2. When I try to start a program sequence, it will not run. “No Active Channel” is displayed.

A2. Ensure the channel(s) is activated (not set to OFF) in the FUNC→Program→Active Channel menu.

Q3. When trying to save to USB, the USB memory stick is unresponsive.

A3. Try restarting the PEL mainframe. If this fails to solve the problem, ensure the USB memory is cleanly formatted.

Q4. When I try to clear an alarm, it doesn't work.

A4. Before clearing an alarm or using the Protection Clear All function, the load must be turned off. After the load is off, the alarm(s) can be cleared.

Q5. Settings aren't saved to internal memory.

A5. If settings can't be saved to internal memory, the internal battery may be flat. See page 243 for details.

For more information, contact your local dealer or GWInstek at www.gwinstek.com / marketing@goodwill.com.tw.

APPENDIX

Fuse Replacement

- Step
1. Turn off the power at the wall socket and rear panel. Remove the power cord.
 2. Remove the fuse socket using a minus driver.

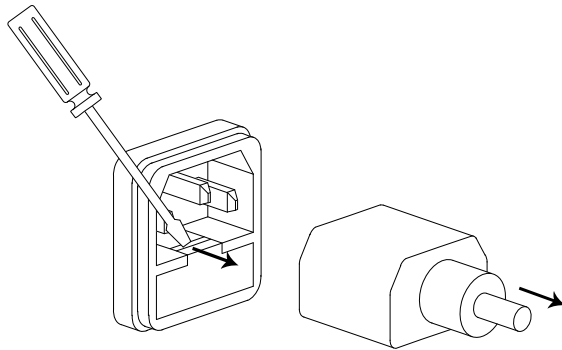

3. Replace the fuse in the holder.

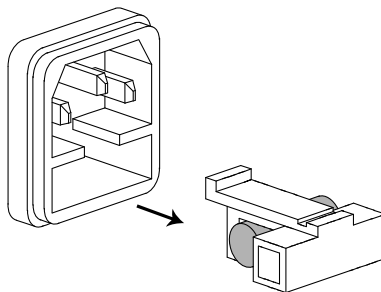

Rating T3.15A, 250V

Battery Replacement

Background The onboard battery is used to power the real time clock and memory.

- Step**
1. Remove the screws from the rear feet (X4).
 2. Remove the three screws from the side panels (X6).
 3. Pull and case back slightly and lift to remove.
 4. Remove the retaining strap from the battery socket and replace the battery.

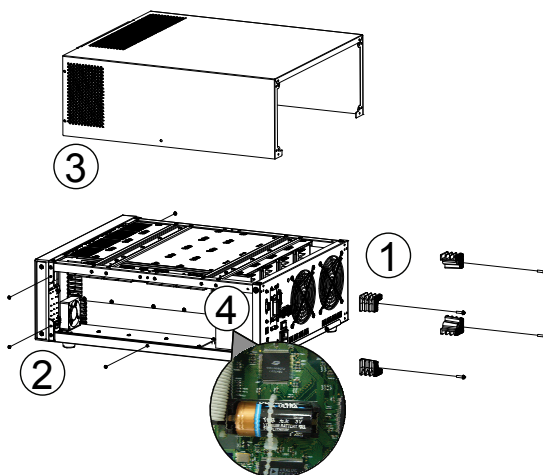

Rating (CR17345) Lithium manganese dioxide battery.
DL123 (Duracell Ultra 123) 1400mAh, 3.0V
(Nominal)

Disposal



Do not dispose the battery as unsorted municipal waste. Please use a separate collection facility or contact the supplier from which the battery was purchased.

Firmware Update

Background The PEL-2000 firmware can be easily updated using a USB memory stick. For the latest firmware please see your local GW Instek distributor or download the latest firmware from www.gwinstek.com.

File Name File: P2KXXXX.UPG



Note

Copy the firmware file (*.UPG) into the root directory of a USB stick before proceeding with the firmware update.

Panel operation

1. Insert a USB flash drive into the front panel USB slot.

2. Press the File key.



3. Press F1 repeatedly until the Media USB menu appears.

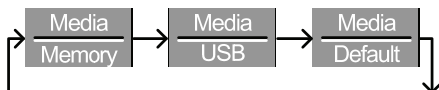

4. Press F5 (File Utility).



5. Use the selector knob to scroll down to the firmware file (*.UPG) and press the selector knob, enter or F1.

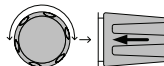

6. Press F1 to confirm the firmware upgrade.



7. Wait for the firmware upgrade to finish, a message will be displayed upon completion.

- Turn the power Off and On from the front panel to reset the load generator.



Do not turn the load generator off or remove the USB memory when the firmware is being read or upgraded.

Calibration

Background The PEL-2000 load generator should be calibrated at least on a yearly basis.

GWInstek does not support End-User calibration. Please see your distributor for calibration details.

Range Chart

PEL-2020

Low Range

100W

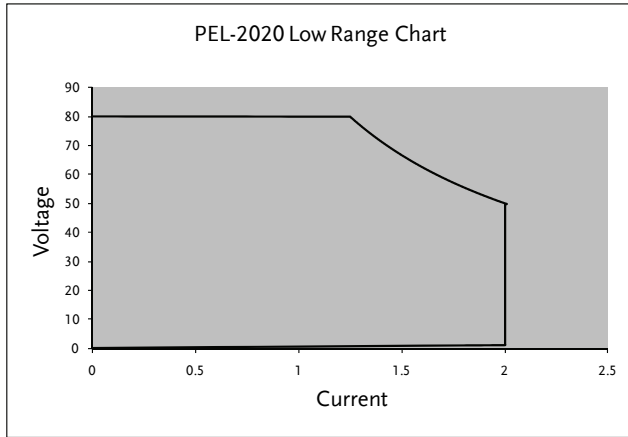

PEL-2020

High Range

100W

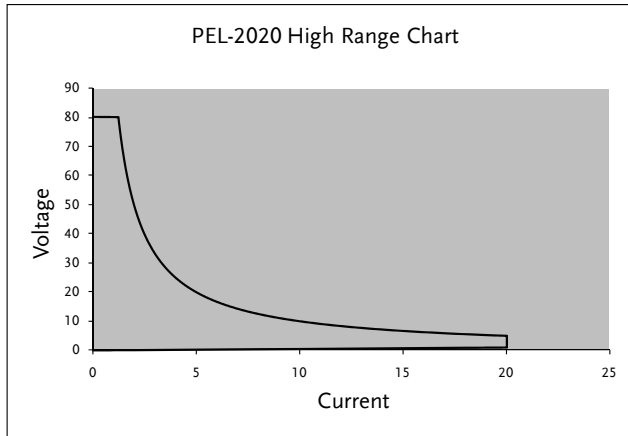

PEL-2030

Left Channel

30W

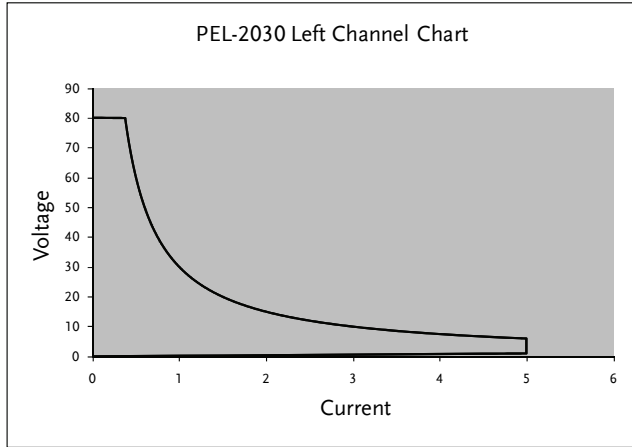

PEL-2030

Right Channel

Low Range

250W

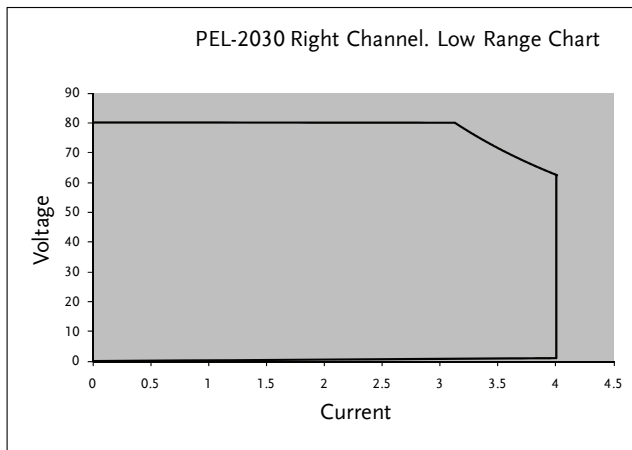

PEL-2030

Right Channel

High Range

250W

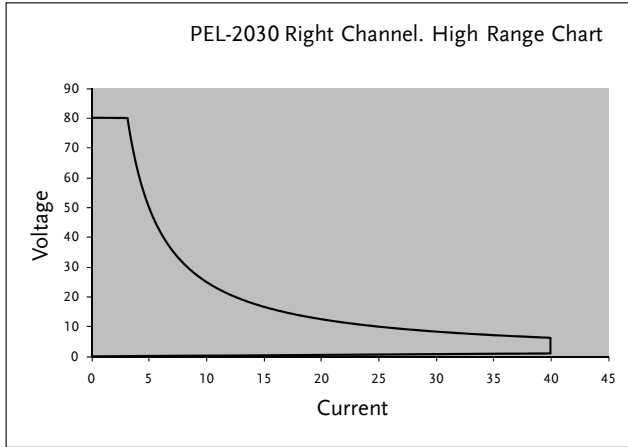

PEL-2040

Low Range

350W

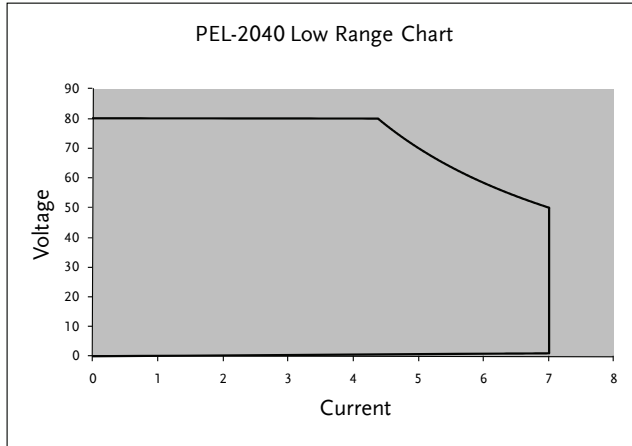

PEL-2040

High Range

350W

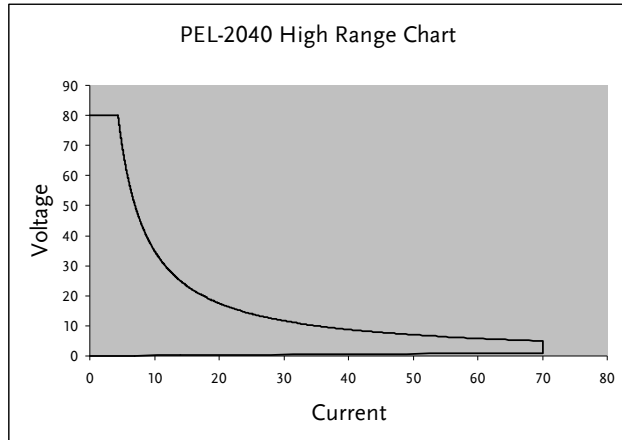

PEL-2041

Low Range

350W

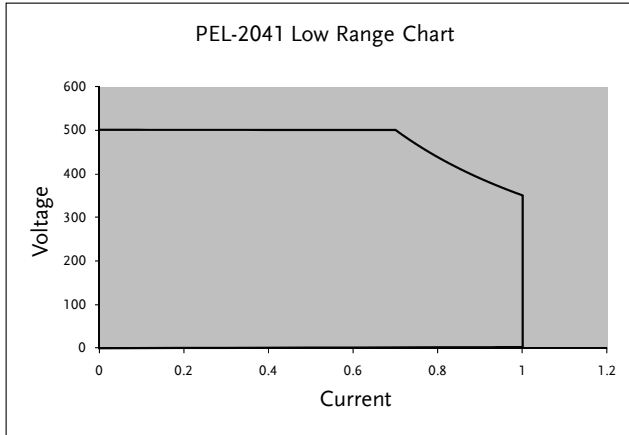

PEL-2041

High Range

350W

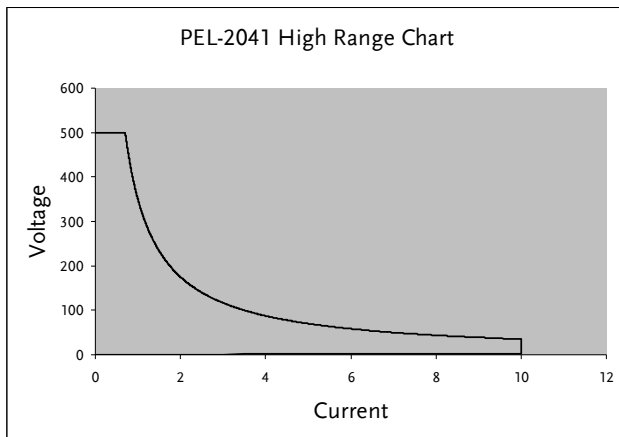

Default Settings

Menu Item		
CC Mode	Mode: Static	A/B Value: Min A
	Rising Slew Rate: Max	Falling Slew Rate: Max
CR Mode	Mode: Static	A Value: Max Ω
	Rising Slew Rate: Max	Falling Slew Rate: Max
CV Mode	Response: Slow	A Value: Max V
	Curr Limit: Max A	
Chan- Protection	OCP Level: Max	OCP Setting: OFF
	OVP Level: Max	OVP Setting: OFF
	OPP Level: Max	OPP Setting: OFF
	UVP Level: Off	UVP Setting: Clear
	Protection Clear: All	
Chan- Other	CC Vrange: High	Von Voltage: 0V
	Von Latch: Off	Short Key: Toggle
	CH CONT: OFF	Independent: OFF
	Load D-Time: 0.0s	CCH Step: Min
	CRH Step: Min	CRL Step: Min
	CV Step: Min	
Chan- Seq. Edit	A Value: 0	Rising/Falling SlewRate: Max
	Duration Time: 0.001s	
Chan- Seq. Edit - Loop	Repeat: Infinity Times	Start of Loop: 001 Step
	On End Load: OFF	CC Vrange: High
Chan- Go/NoGo	Spec Test: Off	Entry Mode: Value

	High: Max	Low: Min
FUNC- Program	PROG: 01	SEQ: 01
	Memory: 001	Run: Skip
	On-Time: 0.1s	Off-Time: Off
	P/F-Time: Off	On-Time: 0.1s
	Short Channel: All channels	
FUNC- Chain	Start: 01	P01~P12→: Off
FUNC- Run	CH 01~08: Active Off	
FUNC- Sequence	CH01~08: Time Setting Off	SEQ: Off
Utility- Load	Auto Load: Off	Auto Load On: Prog
Utility- Interface	USB	
Utility- Other	Speaker: Off	Contrast: 8
	Brightness: 70	Frame CONT: NA
	Alarm (M): On	Alarm (S): Off
	Knob Type: Updated	Go_NoGo Tone: Off
	Slave Knob: SetValue	Language: English

Specifications

	PEL-2002	PEL-2004
MODULE SLOTS	2	4
GENERAL		
Operating Environment		
Temperature	0°C to 40°C	
Altitude	Up to 2000m	
Location	Indoor, no direct sunlight, dust free, almost non conductive pollution.	
Storage Environment		
Temperature	-10°C to 70°C	
Relative Humidity	< 80%	
Location	Indoor	
Power Supply	AC 115V±15%/230V±15% switchable, 50/60Hz, Transient overvoltage on the main supply is 2500V.	
Fuse	T3.15A/250V	
Battery	CR17345	
Pollution degree	2	
Measurement Category	1	

PEL-2020 (100Wx2)		
CHANNELS	2	
CHANNEL	Left/Right	Left/Right
RANGE	Low	High
POWER	100W	100W
CURRENT	0~2A	0~20A
VOLTAGE	1~80V	
MIN.OPERATING VOLTAGE(dc)	1.0V at 2A	1.0V at 20A

STATIC MODE

CONSTANT CURRENT MODE

Range	0~2A	0~20A
Resolution	0.5mA	5mA
Accuracy	$\pm(0.1\%set + 0.1\%F.S.)$	$\pm(0.1\%set + 0.2\%F.S.)$

CONSTANT RESISTANCE MODE

Range	0.075Ω~300Ω(100W/16V) 3.75Ω~15KΩ(100W/80V)
Resolution	12bits
Accuracy	300Ω : $\pm(0.2\%set(\overline{\tau}) + 0.1\overline{\tau})$ 15KΩ: $\pm(0.1\%set(\overline{\tau}) + 0.02\overline{\tau})$ with $\geq 2.5V$ at input

CONSTANT VOLTAGE MODE

Range	1~80V
Resolution	20mV
Accuracy	$\pm(0.05\%set + 0.1\%F.S.)$
Range	0~20A
Resolution	5mA
Accuracy	$\pm(0.1\%set + 0.2\%F.S.)$

DYNAMIC MODE

CONSTANT CURRENT MODE

T1&T2	0.025mS ~ 10mS / Res : 1uS 10mS ~ 30S / Res : 1mS	
Accuracy	1uS / 1mS $\pm 100ppm$	
Slew Rate	0.32 ~ 80mA/uS	3.2 ~ 800mA/uS
Slew Rate	0.32mA/uS	3.2mA/uS
Resolution		
Slew Rate setting	$\pm(10\% + 15us)$	$\pm(10\% + 15us)$
Accuracy		
Current	0~2A	0~20A
Current	0.5mA	5mA
Resolution		

Current Accuracy	$\pm 0.4\%$ F.S.	
MEASUREMENT		
VOLTAGE READBACK		
Range	0~16V	0~80V
Resolution	0.5mV	2.5mV
Accuracy	$\pm(0.05\% \text{set} + 0.05\% \text{ F.S.})$	
CURRENT READBACK		
Range	0~2A	0~20A
Resolution	0.0625mA	0.625mA
Accuracy	$\pm(0.1\% \text{set} + 0.1\% \text{ F.S.})$	
PROTECTIVE		
Over Power Protection		
Range	1~102W	
Resolution	0.5W	
Accuracy	$\pm(2\% \text{set} + 0.25\% \text{ F.S.})$	
Over Current Protection		
Range	0.25~20.4A	
Resolution	0.05A	
Accuracy	$\pm(2\% \text{set} + 0.25\% \text{ F.S.})$	
Over Voltage Protection		
Range	1~81.6V	
Resolution	0.2V	
Accuracy	$\pm(2\% \text{set} + 0.25\% \text{ F.S.})$	
Over Temperature Protection	$\cong 85^{\circ}\text{C}$	
Rated Power Protection :		
Value	110W	
Accuracy	$\pm 2\% \text{set}$	
GENERAL		
SHORT CIRCUIT		
Current(CC)	$\cong 2.2/2\text{A}$	$\cong 22/20\text{A}$
Voltage(CV)	0V	0V
Resistance(CR)	$\cong 3.75\Omega$	$\cong 0.075\Omega$
INPUT RESISTANCE (LOAD OFF)	800K Ω (Typical)	

PEL-2030 (30W/250W)			
CHANNELS	2		
CHANNEL	Left	Right	Right
RANGE	N/A	Low	High
POWER	30W	250W	250W
CURRENT	0~5A	0~4A	0~40A
VOLTAGE	1~80V		
MIN.OPERATING VOLTAGE(dc)	1.0V at 5A	1.0V at 4A	1.0V at 40A

STATIC MODE

CONSTANT CURRENT MODE

Range	0~5A	0~4A	0~40A
Resolution	1mA	1mA	10mA
Accuracy	$\pm(0.1\%set + 0.1\%F.S)$	$\pm(0.1\%set + 0.1\%F.S)$	$\pm(0.1\%set + 0.2\%F.S)$

CONSTANT RESISTANCE MODE

Range	0.3Ω~1.2KΩ (30W/16V) 15Ω~60KΩ (30W/80V)	0.0375Ω~150Ω(250W/16V) 1.875Ω~7.5KΩ(250W/80V)
Resolution	12bits	
Accuracy	12KΩ : $\pm(0.2\%set(\overline{\tau}) + 0.1\overline{\tau})$ 60KΩ : $\pm(0.1\%set(\overline{\tau}) + 0.02\overline{\tau})$ with $\geq 2.5V$ at input	150Ω : $\pm(0.2\%set(\overline{\tau}) + 0.1\overline{\tau})$ 7.5KΩ: $\pm(0.1\%set(\overline{\tau}) + 0.02\overline{\tau})$ with $\geq 2.5V$ at input

CONSTANT VOLTAGE MODE

Range	1~80V	
Resolution	20mV	
Accuracy	$\pm(0.05\%set + 0.1\%F.S.)$	
Range	0~5A	0~40A
Resolution	1mA	10mA
Accuracy	$\pm(0.1\%set + 0.1\%F.S.)$	$\pm(0.1\%set + 0.2\%F.S.)$

DYNAMIC MODE

CONSTANT CURRENT MODE

T1&T2	0.025mS ~ 10mS / Res : 1uS 10mS ~ 30S / Res : 1mS		
Accuracy	1uS / 1mS + 100ppm		
Slew Rate	0.8 ~ 200mA/uS	0.64 ~ 160mA/uS	6.4 ~ 1600mA/uS
Slew Rate	0.8mA/uS	0.64mA/uS	6.4mA/uS
Resolution			
Slew Rate setting	±(10% + 15us)	±(10% + 15us)	±(10% + 15us)
Accuracy			
Current	0~5A	0~4A	0~40A
Current	1mA	1mA	10mA
Resolution			
Current Accuracy	±0.4% F.S.		

MEASUREMENT

VOLTAGE READBACK

Range	0~16V	0~80V	0~16V	0~80V
Resolution	0.5mV	2.5mV	0.5mV	2.5mV
Accuracy	±(0.05%set + 0.05% F.S.)			

CURRENT READBACK

Range	0~5A	0~4A	0~40A
Resolution	0.15625mA	0.125mA	1.25mA
Accuracy	±(0.1%set + 0.1% F.S.)		

PROTECTIVE

Over Power Protection

Range	0.9~30.6W	1.25~255W
Resolution	0.15W	1.25W
Accuracy	±(2%set + 0.25%F.S)	±(2%set + 0.25%F.S)

Over Current Protection

Range	0.0625~5.1A	0.5~40.8A
Resolution	0.0125A	0.1A
Accuracy	±(2%set + 0.25%F.S)	±(2%set + 0.25%F.S)

Over Voltage Protection

Range	1~81.6V	1~81.6V
Resolution	0.2V	0.2V
Accuracy	±(2%set + 0.25%F.S)	±(2%set + 0.25%F.S)

Over Temperature Protection $\approx 85^{\circ}\text{C}$

Rated Power Protection :

Value	33W	275W
Accuracy	$\pm 2\%$ set	$\pm 2\%$ set

GENERAL

SHORT CIRCUIT

Current(CC)	$\approx 5.5/5\text{A}$	$\approx 4.4/4\text{A}$	$\approx 44/40\text{A}$
Voltage(CV)	0V	0V	0V
Resistance(CR)	$\approx 15\Omega$	$\approx 0.3\Omega$	$\approx 1.875\Omega$
			$\approx 0.0375\Omega$

INPUT RESISTANCE (LOAD OFF) $800\text{K}\Omega$ (Typical)

	PEL-2040		PEL-2041	
CHANNELS	1		1	
RANGE	Low	High	Low	High
POWER	350W	350W	350W	350W
CURRENT	0~7A	0~70A	0~1A	0~10A
VOLTAGE	1~80V		2.5~500V	
MIN.OPERATING VOLTAGE(dc)	1.0V at 7A	1.0V at 70A	2.5V at 1A	2.5V at 10A

STATIC MODE

CONSTANT CURRENT MODE

Range	0~7A	0~70A	0~1A	0~10A
Resolution	1mA	10mA	0.2mA	2mA
Accuracy	$\pm(0.1\% \text{set} + 0.1\% \text{F.S})$	$\pm(0.1\% \text{set} + 0.2\% \text{F.S})$	$\pm(0.1\% \text{set} + 0.1\% \text{F.S})$	$\pm(0.1\% \text{set} + 0.2\% \text{F.S})$

CONSTANT RESISTANCE MODE

Range	0.025 Ω ~100 Ω (350W/16V) 1.25 Ω ~5K Ω (350W/80V)	1.25 Ω ~5K Ω (350W/125V) 50 Ω ~200K Ω (350W/500V)
Resolution	12bits	12bits
Accuracy	100 Ω : $\pm(0.2\% \text{set}(\tau) + 0.1\tau)$ 5K Ω : $\pm(0.1\% \text{set}(\tau) + 0.02\tau)$ with $\geq 2.5\text{V}$ at input	5K Ω : $\pm(0.2\% \text{set}(\tau) + 0.02\tau)$ 200K Ω : $\pm(0.1\% \text{set}(\tau) + 0.01\tau)$ with $\geq 5\text{V}$ at input

CONSTANT VOLTAGE MODE

Range	1~80V	2.5~500V
Resolution	20mV	100mV
Accuracy	$\pm(0.05\% \text{set} + 0.1\% \text{F.S.})$	$\pm(0.05\% \text{set} + 0.1\% \text{F.S.})$
Range	0~70A	0~10A
Resolution	10mA	2mA
Accuracy	$\pm(0.1\% \text{set} + 0.2\% \text{F.S.})$	$\pm(0.1\% \text{set} + 0.2\% \text{F.S.})$

DYNAMIC MODE

CONSTANT CURRENT MODE

T1&T2	0.025mS ~ 10mS / Res : 1 μ S	0.025mS ~ 10mS / Res : 1 μ S
	10mS ~ 30S / Res : 1mS	10mS ~ 30S / Res : 1mS
Accuracy	1 μ S / 1mS \pm 100ppm	1 μ S / 1mS \pm 100ppm
Slew Rate	0.001 ~ 0.28A/ μ S	0.01 ~ 2.8A/ μ S
	0.001A/ μ S	0.01A/ μ S
Slew Rate Resolution	0.16 ~ 40mA/ μ S	1.6 ~ 400mA/ μ S
Slew Rate setting Accuracy	$\pm(10\% + 15\mu\text{s})$	$\pm(10\% + 15\mu\text{s})$
	$\pm(10\% + 15\mu\text{s})$	$\pm(10\% + 15\mu\text{s})$

Current	0~7A	0~70A	0~1A	0~10A
Current	1mA	10mA	0.2mA	2mA
Resolution				
Current Accuracy	±0.4% F.S.		±0.4% F.S.	

MEASUREMENT

VOLTAGE READBACK

Range	0~16V	0~80V	0~125V	0~500V
Resolution	0.5mV	2.5mV	4mV	16mV
Accuracy	±(0.05%set + 0.05% F.S.)		±(0.05%set + 0.05% F.S.)	

CURRENT READBACK

Range	0~7A	0~70A	0~1A	0~10A
Resolution	0.175mA	1.75mA	0.032mA	0.32mA
Accuracy	±(0.1%set + 0.1% F.S.)		±(0.1%set + 0.1% F.S.)	

PROTECTIVE

Over Power Protection

Range	1.75~357W	1.75~357W
Resolution	1.75W	1.75W
Accuracy	±(2%set + 0.25%F.S)	

Over Current Protection

Range	0.875~71.4A	0.125~10.2A
Resolution	0.175A	0.025A
Accuracy	±(2%set + 0.25%F.S)	

Over Voltage Protection

Range	1~81.6V	2.5~500V
Resolution	0.2V	1.25V
Accuracy	±(2%set + 0.25%F.S)	
Over Temperature Protection	≒85°C	

Rated Power Protection :

Value	385W	385W
Accuracy	±2%set	±2%set ±2%set

GENERAL

SHORT CIRCUIT

Current(CC)	≒7.7/7A	≒77/70A	≒1.1/1A	≒11/10A
Voltage(CV)	0V	0V	0V	0V
Resistance(CR)	≒1.25Ω	≒0.025Ω	≒50Ω	≒1.25Ω

INPUT 800KΩ(Typical) 800KΩ(Typical)

RESISTANCE (LOAD OFF)

Dimensions

PEL-2002/PEL-2004

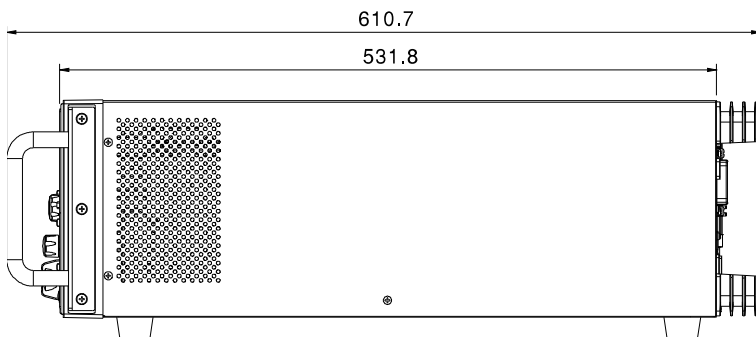
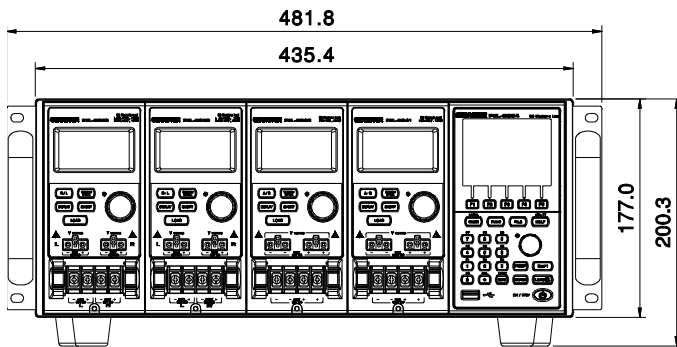
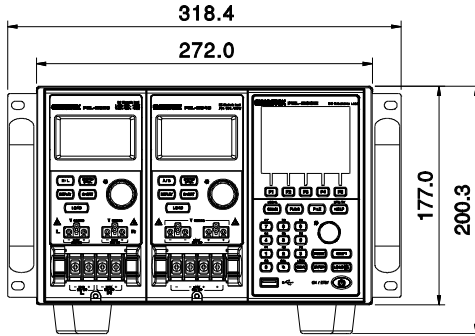

PEL-2020/PEL-2030/PEL-2040/PEL2041

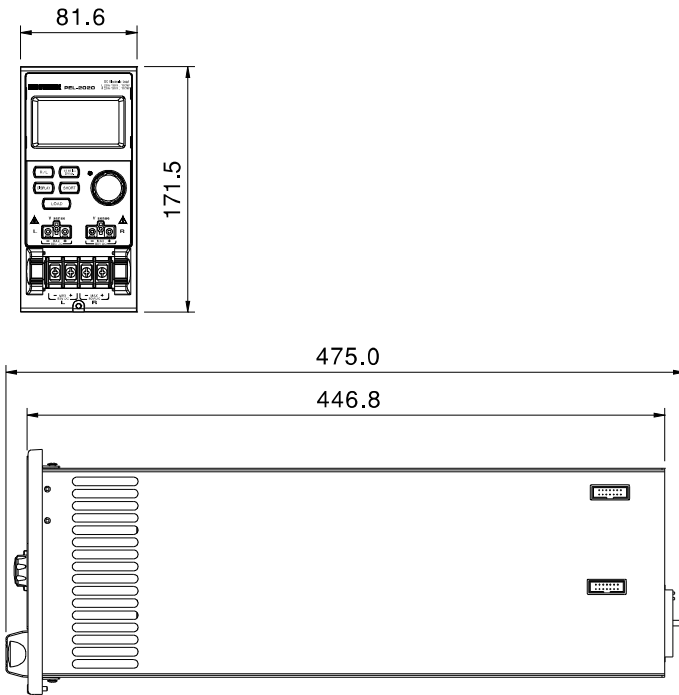

EC Declaration of Conformity

We
GOOD WILL INSTRUMENT CO., LTD.
 (1) No.7-1, Jhongsing Rd., Tucheng City, Taipei County, Taiwan
 (2) No. 69, Lu San Road, Suzhou City (Xin Qu), Jiangsu Sheng, China
 declare, that the below mentioned product
 Type of Product: Programmable Electronic Load
 Model Number: **PEL-2004, PEL-2002, PEL-2020, PEL-2030, PEL-2040, PEL-2041**
 are herewith confirmed to comply with the requirements set out in the Council Directive on the Approximation of the Law of Member States relating to Electromagnetic Compatibility (2004/108/EC) and Low Voltage Directive (2006/95/EC).
 For the evaluation regarding the Electromagnetic Compatibility and Low Voltage Directive, the following standards were applied:

⊙ EMC

Electrical equipment for measurement, control and laboratory use-- EMC requirements (2004/108/EC)	
Harmonized Standard	EN 61326-1:2006
Conducted & Radiated Emission CISPR11: 2003+A1:2004+A2:2006	Electrostatic Discharge IEC 61000-4-2: 2008
Current Harmonics EN 61000-3-2: 2006	Radiated Immunity IEC 61000-4-3: 2008
Voltage Fluctuations EN 61000-3-3: 2008	Electrical Fast Transients IEC 61000-4-4: 2004+Corr.1:2006+Corr.2:2007
-----	Surge Immunity IEC 61000-4-5: 2005
-----	Conducted Susceptibility IEC 61000-4-6: 2003+A1: 2004 +A2 :2006
-----	Power Frequency Magnetic Field IEC 61000-4-8: 2001
-----	Voltage Dip/ Interruption IEC 61000-4-11: 2004

⊙ Safety

Low Voltage Equipment Directive 2006/95/EC	
Safety Requirements	IEC/EN 61010-1: 2001

INDEX

- Alarm configuration 190
- All Chan save/recall
 - description..... 93
- Battery disposal 243
- Battery replacement 243
- Baud rate configuration..... 196
- Brightness & contrast..... 185
- Calibration..... 245
- Calibration key 19
- CC vrange mode description 81
- CC+CV mode..... 69
- Channel configuration
 - CC voltage range..... 165
 - Go/NoGo mode..... 177
 - Go/NoGo On/Off 179
 - Independent setting 171
 - Load delay time..... 173
 - Protection All Clear 165
 - SPEC test ON/OFF 179
 - Step resolution..... 175
- Channel configuration
 - Configuration menu 161
 - OCP/OCV/OPP 162
- Channel configuration
 - Von voltage configuration . 167
- Channel configuration
 - Short..... 168
- Channel configuration
 - channel control 170
- Channel control configuration 170, 235
- Channel control connection .. 56
- Channel control description.. 85
- Channel control mode
 - description..... 83
- Channel duration time
 - settings mode description . 77
- Cleaning the instrument 7
- Clear key 19
- Configuration mode
 - description..... 79
- Connection
 - Channel control 56
 - Frame link 54
 - Go/NoGo control..... 59
 - Remote sense..... 48
 - Wire gauge 44
 - Wire Inductance 44
- Connection procedure 46
- Constant Resistance mode
 - description..... 65
- Constant voltage + constant
 - current mode description.. 69
- Constant voltage mode
 - description..... 68
- Date and time configuration 183
- Default Settings 251
- Delay time mode description 84
- Dimensions..... 261
- Display key..... 29
- Display settings 185
- Disposal instructions 8
- Dynamic constant current
 - mode description..... 62
- Dynamic loads Constant
 - Resistance mode description 66
- EC Declaration of Conformity 263
- EN61010
 - measurement category 6
 - Pollution degree 8

- Enter key21
- Environment
 - operation 8
 - Storage8
- External memory save
 - description92
- External voltage mode
 - description85
- Features12
- File format mode description 94
- Firmware update.....244
- Frame control congifuration 187
- Frame Link configuration236
- Frame link connection54
- Front panel overview.....17
- Function Keys17
- Fuse
 - rating7
- Fuse replacement242
- Go/NoGo Alarm Sound191
- Go/NoGo connection.....59
- Go/NoGo constant current
 - mode description63
- Go/NoGo constant Resistance
 - mode description66
- Go/NoGo constant voltage
 - mode description70
- Go/NoGo interface
 - configuration239
- GPIB card installation.....38
- GPIB configuration198, 234
- Independent configuration ..171
- Independent mode description83
- Installation
 - GPIB card38
 - Load module35
 - Rack mount39
- Interface configuration233
 - Baud Rate196
 - GPIB198
 - Interface menu195
 - RS232.....196
 - USB configuration199
- Internal memory save
 - description92
- Knob configuration188
- Language Settings194
- List of features12
- Load (module)key29
- Load connections43
- Load Connections
 - Auxiliary voltage connection51
 - DC Connection.....51
 - Dual channel load module ...50
 - Low voltage connections51
 - Multiple output power source53
 - Parallel load modules.....52
 - Parallel loads52
 - Parallel mainframes.....53
 - Precautions43
 - Single channel load module .50
 - Single load50
- Load delay time configuration173
- Load D-Time mode
 - description84
- Load key21
- Load Menu182
- Load module installation35
- Load module Overview28
- Load profiling description74
- Load terminals.....29
- Load wire induction44
- Load wiring.....45
- Local operation
 - A&B Value113
 - Channel selection.....113
 - Display117
 - Dynamic.....114
 - Editing the load.....118
 - Load.....115
 - Operation.....112
 - R/L keys113
 - Shorting.....116
 - Static114
- Lock key19

Mainframe configuration	Trig out	155
alarm sound	Measurement types	15, 16
Brightness & contrast.....	Memory data description.....	90
Configuration menu	Number pad	19
Date & time	Operating configurations	
Frame control.....	mode description.....	81
Go/NoGo Tone	Operating Description	60
Knob type.....	Operating Modes	
Language.....	Channel duration time	
Load menu	settings	77
Slave Knob	Configuration.....	79
Speaker	Configuration - Over current	
System Info	protection.....	80
Utility menu.....	Configuration - Over power	
Mainframe operation	protection.....	80
CC Dynamic mode.....	Configuration - Over voltage	
CC Mode	protection.....	80
CC Range	Constant current - Go/NoGo63	
CC Static mode	Constant current - Slew rate 63	
CC Static Values	Constant current -Dynamic..	62
Channel duration time	Constant current -static	62
settings	Constant Resistance	65
Channel Selection.....	Constant Resistance -	
CR Range.....	Dynamic loading.....	66
CR Static Parameters	Constant Resistance - Slew	
CR Dynamic mode.....	rate	66
CR mode.....	Constant Resistance	
CR Static mode	Go/NoGo.....	66
CV Current limit	Constant Voltage.....	68
CV mode.....	Constant Voltage - Response	
CV response speed.....	speed.....	70
CV Voltage values.....	Constant Voltage + Constant	
Edit Sequence	Current Mode.....	69
Program chain	Constant Voltage -Go/NoGo70	
Program Execution	Constant Voltage -levels.....	68
Program Sequences.....	External Voltage Control.....	85
Programming.....	File format	94
Recall default chain.....	File System	89
Recall default sequence	Go/NoGo	73
Run Sequence	Interface	89
Save chain	Memory data.....	90
Save Program chain	Operating Configuration s -	
Save sequence.....	Von Voltage	82
Sequence loop.....	Operating Configurations	81

Operating Configurations - CC vrange	81	Power key	21
Operating Configurations - independent	83	Power supply Safety information	7
Operating Configurations - Load D-Time	84	Power up	41
Operating Configurations - Short	83	Power up sequence	41
Operating Configurations - Step Resolution	84	Preset data description	90
Parallel Dynamic Loading	78	Preset key	20
Preset data	90	Program Chain mode description	72
Program Chain	72	Program mode description	71
Reverse voltage protection	81	Protection All clear	165
Run Program	71	Quick save Presets to internal memory	228
save/recall All Chan	93	R/L key	28
SEQ data	91	Rack mount installation	39
Sequences	74	Range Chart	246
Setup data	91	Recall factory defaults	231
Trig Out	76	Recall Memory data to USB	216
USB save/recall	93	Recall Presets - Framelink	230
Operation		Recall Setups - Framelink	229
Contents	109	Remote sense connections	48
Local load	112	Response speed constant voltage mode description	70
Operation Environment	8	Reverse voltage protection	81
Operation keys	20	RS232 configuration	196
Over Current mode description	80	RS-232C configuration	233
Over power mode description	80	Safety Instructions	5
Over protection configuration	162	Safety symbols	5
Over voltage mode description	80	Save Memory data	202
Overview	13	Save Memory data to USB	216
Display Overview	22	Save Preset memory	204
Front panel	17	Save presets to USB	220
LED display	32	Save Sequences to USB	224
Load module	28	Save setup memory	206
Rear Panel	25	Save setup to USB	213
Parallel Dynamic loading description	78	Save to internal memory	202, 208
pass/fail test multiple step tutorial	97	Save to internal setup memory	206
		Save/Recall default USB path	208
		FrameLink Preset Recall	230
		FrameLink Setup Recall	229
		Preset memory	204

Quick save Presets to internal memory	228	Static constant current mode description.....	62
Recall factory defaults	231	Static/ Dynamic key	30
Recall Memory data to USB216		Step resolution	175
Save Memory data to USB .	216	Step Resolution mode description.....	84
Save Preset Memory	204	Storage Environment	8
Save presets to USB.....	220	System Info.....	181
Save SEQ (Sequences) to USB224		System Keys	18
Save setup to USB	213	Terminals.....	29
Save to internal Memory	208	Trig out	155
Save to setup Memory	206	Trig out mode description.....	76
Setup memory	206	Tutorials	
USB path.....	208	Channel control	106
Save/Recall		Frame link	104
File menu.....	201	General configuration options	108
Memory data	202	Local load	97
Save to internal Memory	202	Program	103
Selector Knob	20	Single load	99
Selector knob-loadmodule	30	Tutorials	
SEQ data description	91	Basic Operation.....	96
Sequence editing/creating ..	151	Twisted pair description	45
Sequence mode description ..	74	UK power cord	9
Sequences mode description.	71	USB configuration	199
service contance point.....	241	USB path.....	208
Setup data description	91	USB remote interface	
Shift key	21	connection	240
Short configuration	168	USB save/recall description .	93
Short key.....	31	Utility Menu.....	181
Shorting mode description....	83	Voltage levels constant	
Slave Knob Settings.....	192	voltage mode description..	68
Slew rage constant current		Voltage sense terminal.....	29
mode description.....	63	Von voltage configuration ..	167
Slew rate Constant Resistance		Von voltage mode description	82
mode description.....	66	Wire Connections	43
Speaker Settings.....	184	Wire gauge	43
Specifications	253	Wire induction.....	44
PEL-2020.....	254	Wiring procedure	46
PEL-2030.....	256		
PEL-2040.....	259		
PEL-2041.....	259		