

**48 dB Gain High Power High Gain Amplifier at
50 Watt Psat Operating From 500 MHz to 3 GHz with
52 dBm IP3 and SMA**

FMAM5032 is a high gain Class A/AB GaN Linear Power Amplifier operating in the 500 to 3000 MHz frequency range. The amplifier offers a Wide Dynamic Range with 50 Watts typical saturated power, 48 dB minimum small signal gain, and ± 2.0 dB gain flatness maximum. The amplifier requires typically a +36V DC power supply, is unconditionally stable, and operates over the temperature range of -20°C and +75°C. Pinouts include TTL Blanking, Remote ON/OFF, DC Current Monitoring, Reset, And Temperature Sensor Monitoring. RF Input/Output Connectors are SMA Female.

Electrical Specifications (TA = +25°C, DC Voltage = 36Volts , DC Current = 8,333mA)

Description	Min	Typ	Max	Unit
Frequency Range	0.5		3	GHz
Small Signal Gain	48			dB
Gain Flatness			± 2	dB
Input Power			+0	dBm
Psat		+47		dBm
Output 3rd Order Intercept Point		+52		dBm
Harmonics @20 Watts		-15		dBc
Spurious @20 Watts		-70	-60	dBc
Input VSWR			2:1	
TTL Control	"1": Off, "0": On (Blanking), Enable: 0V, Disable: 5V			
Operating DC Voltage	28	36	48	Volts
Operating DC Current		8,333		mA
DC Consumption			300	Watts
Operating Temperature Range	-20		+50	°C
Temperature Indication: Analog Voltage Reporting with LM 35 or Equivalent				
Current Indication: Analog Voltage Reporting				

Mechanical Specifications

Size	
Length	6 in [152.4 mm]
Width	5 in [127 mm]
Height	1.1 in [27.94 mm]
Weight	2 lbs [907.18 g]
Input Connector	SMA Female
Output Connector	SMA Female
Cooling	ADEQUATE HEATSINK REQUIRED

Environmental Specifications

Temperature	
Operating Range	-20 to +50 deg C
Humidity	95% Non-Condensing
Shock	MIL-STD-810F Method 516.5
Vibration	MIL-STD-810F Method 516.5
Altitude	10000 feet Above Sea Level



Features:

- 500 MHz to 3000 MHz Frequency Range
- Psat 50 Watts typ
- Small Signal Gain: 48 dB min
- Gain Flatness ± 2.0 dB max
- Class A/AB
- TTL Blanking
- Remote ON/OFF
- 50 Ohms Input and Output Matched
- Unconditionally Stable
- Regulated Supply
- RF Input Signal Format CW/AM/FM/PM/Pulse
- SMA Female RF Connectors
- DC Current Monitoring
- Rest Control
- Temperature Sensor Monitoring

Applications:

- Military Radio
- Communication Systems
- High Gain Driver Power Amplifier
- Medical Industry
- High Gain Output Power Amplifier

Fairview Microwave
1130 Junction Dr. #100
Allen, TX 75013
Tel: 1-800-715-4396 / (972) 649-6678
Fax: (972) 649-6689
www.fairviewmicrowave.com
sales@fairviewmicrowave.com

Compliance Certifications (visit www.FairviewMicrowave.com for current document)

Plotted and Other Data

Notes:

- Values at 25 °C, sea level
- ESD Sensitive Material, Transport material in Approved ESD bags. Handle only in approved ESD Workstation.
- Heat Sink Required for Proper Operation, Unit is cooled by conduction to heat sink.



Typical Performance Data

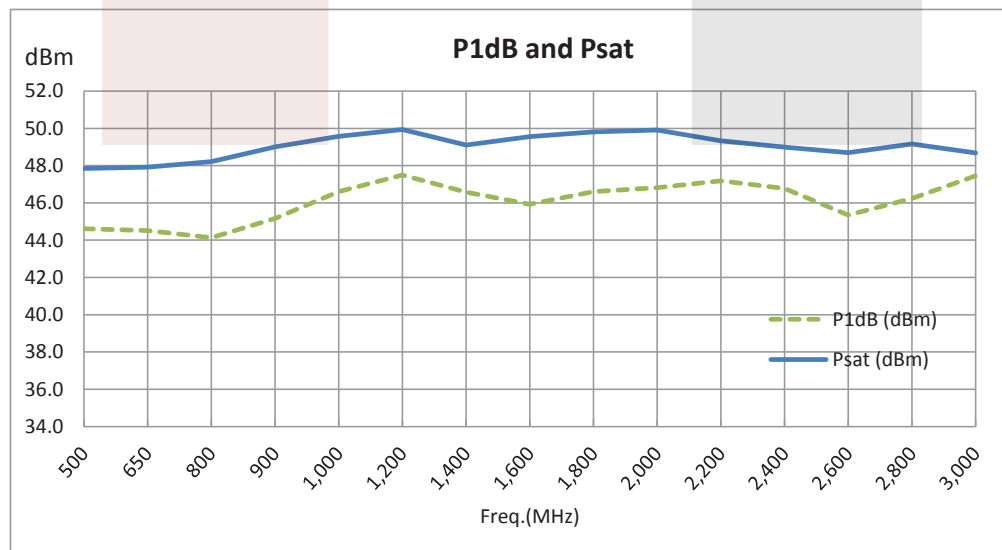
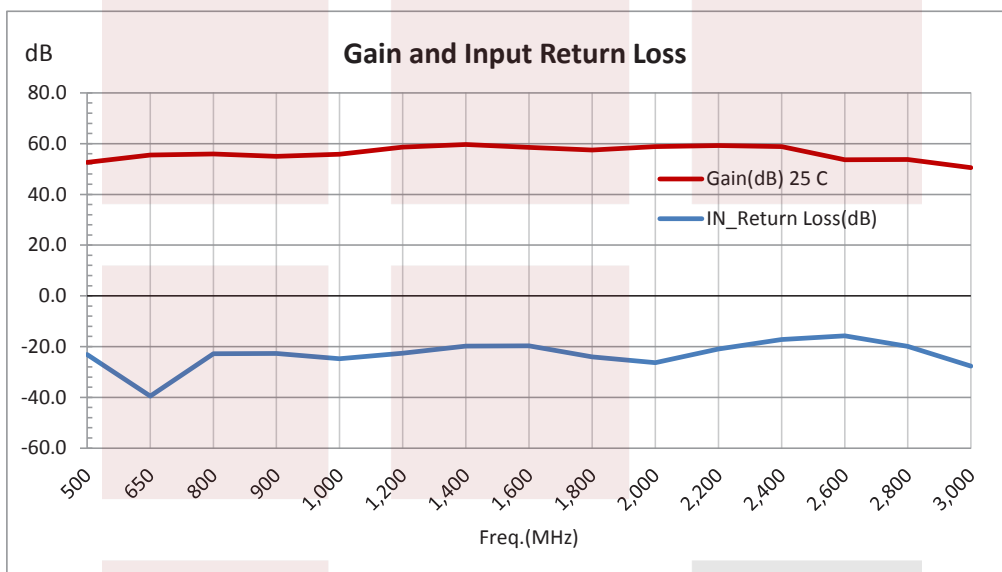

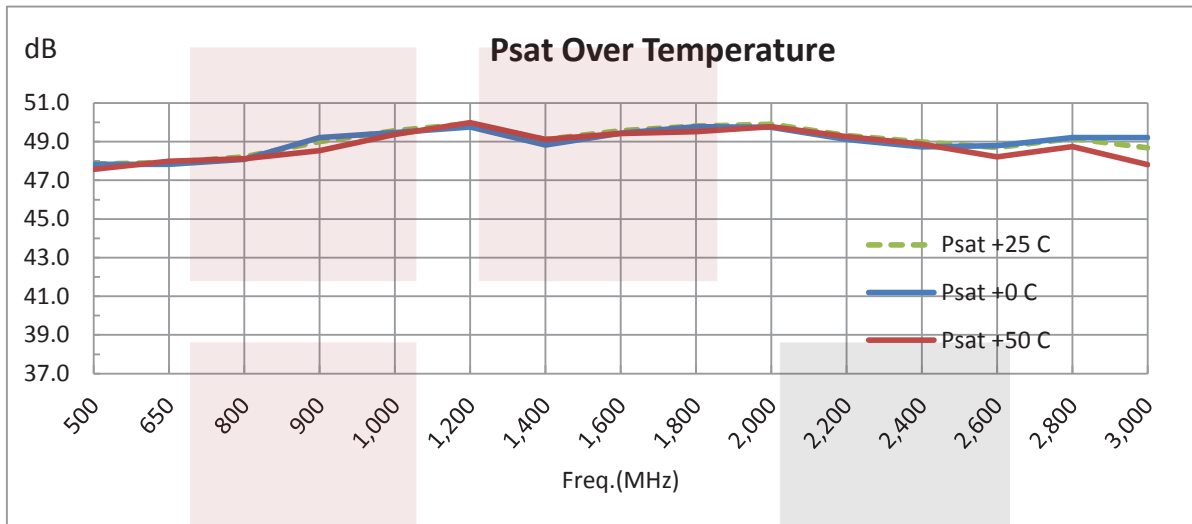
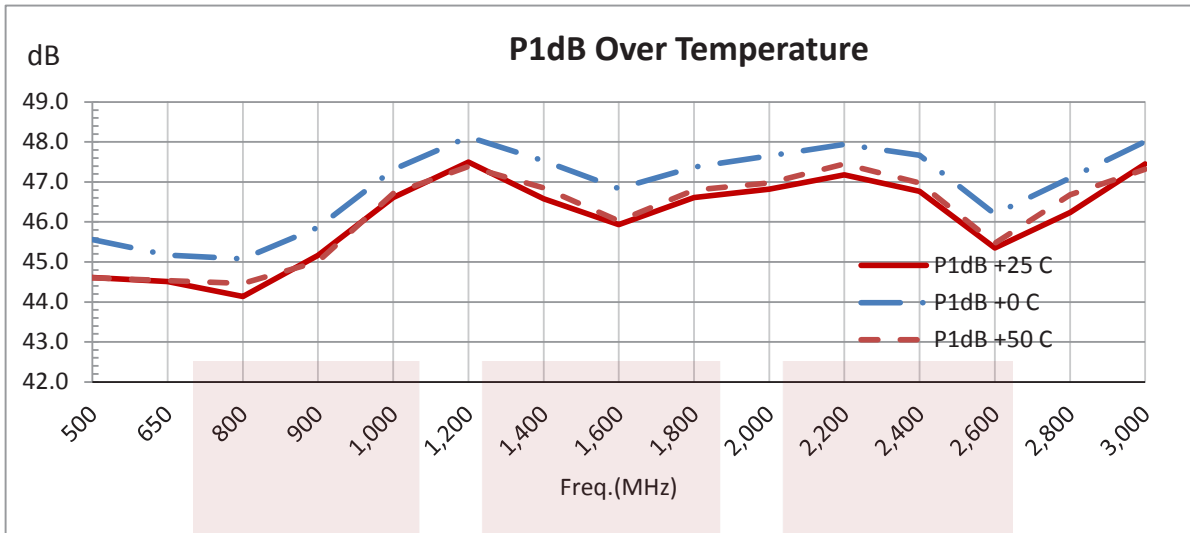

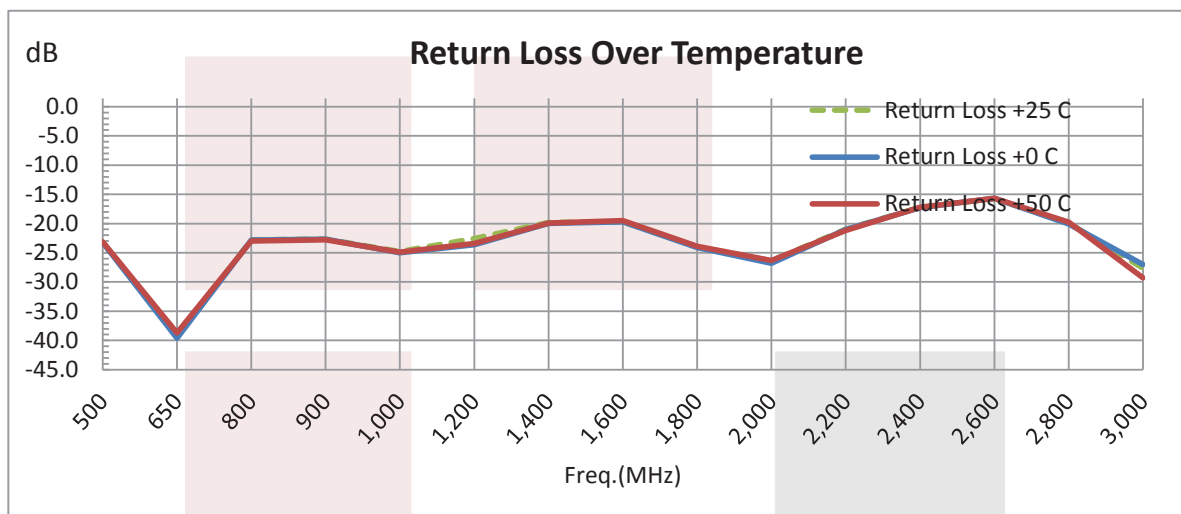
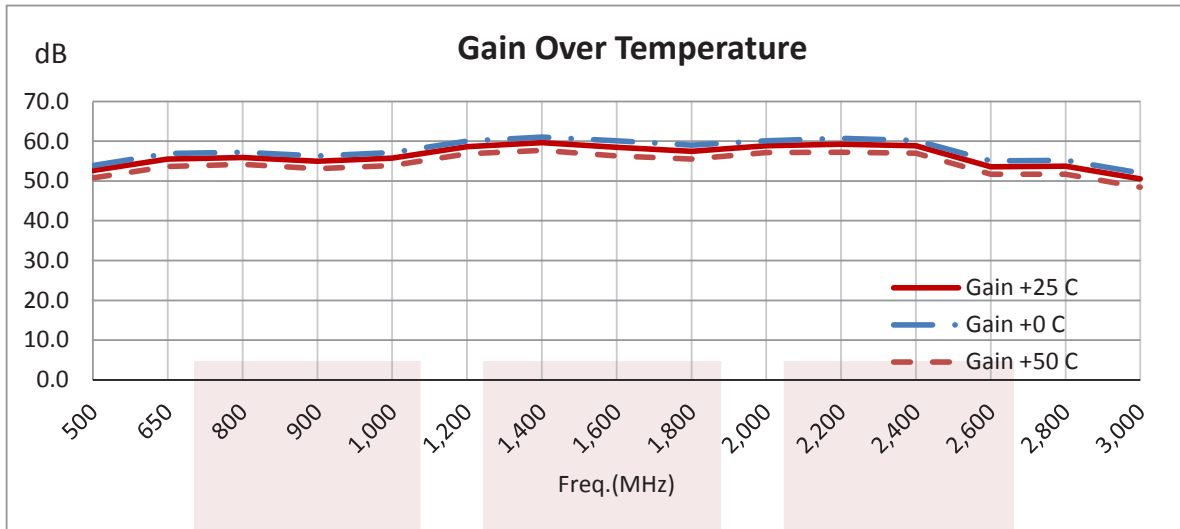

48 dB Gain High Power High Gain Amplifier at 50 Watt Psat Operating From 500 MHz to 3 GHz with 52 dBm IP3 and SMA from Fairview Microwave is in-stock and available to ship same-day. All of our RF/microwave products are available off-the-shelf from our ISO 9001:2008 certified facilities in Allen, Texas. Fairview Microwave is RF on-demand.

For additional information on this product, please click the following link: [48 dB Gain High Power High Gain Amplifier at 50 Watt Psat Operating From 500 MHz to 3 GHz with 52 dBm IP3 and SMA FMAM5032](#)

URL: <https://www.fairviewmicrowave.com/48db-high-power-high-gain-amplifier-50watt-fmam5032-p.aspx>

The information contained in this document is accurate to the best of our knowledge and representative of the part described herein. It may be necessary to make modifications to the part and/or the documentation of the part, in order to implement improvements. Fairview Microwave reserves the right to make such changes as required. Unless otherwise stated, all specifications are nominal. Fairview Microwave does not make any representation or warranty regarding the suitability of the part described herein for any particular purpose, and Fairview Microwave does not assume any liability arising out of the use of any part or documentation.

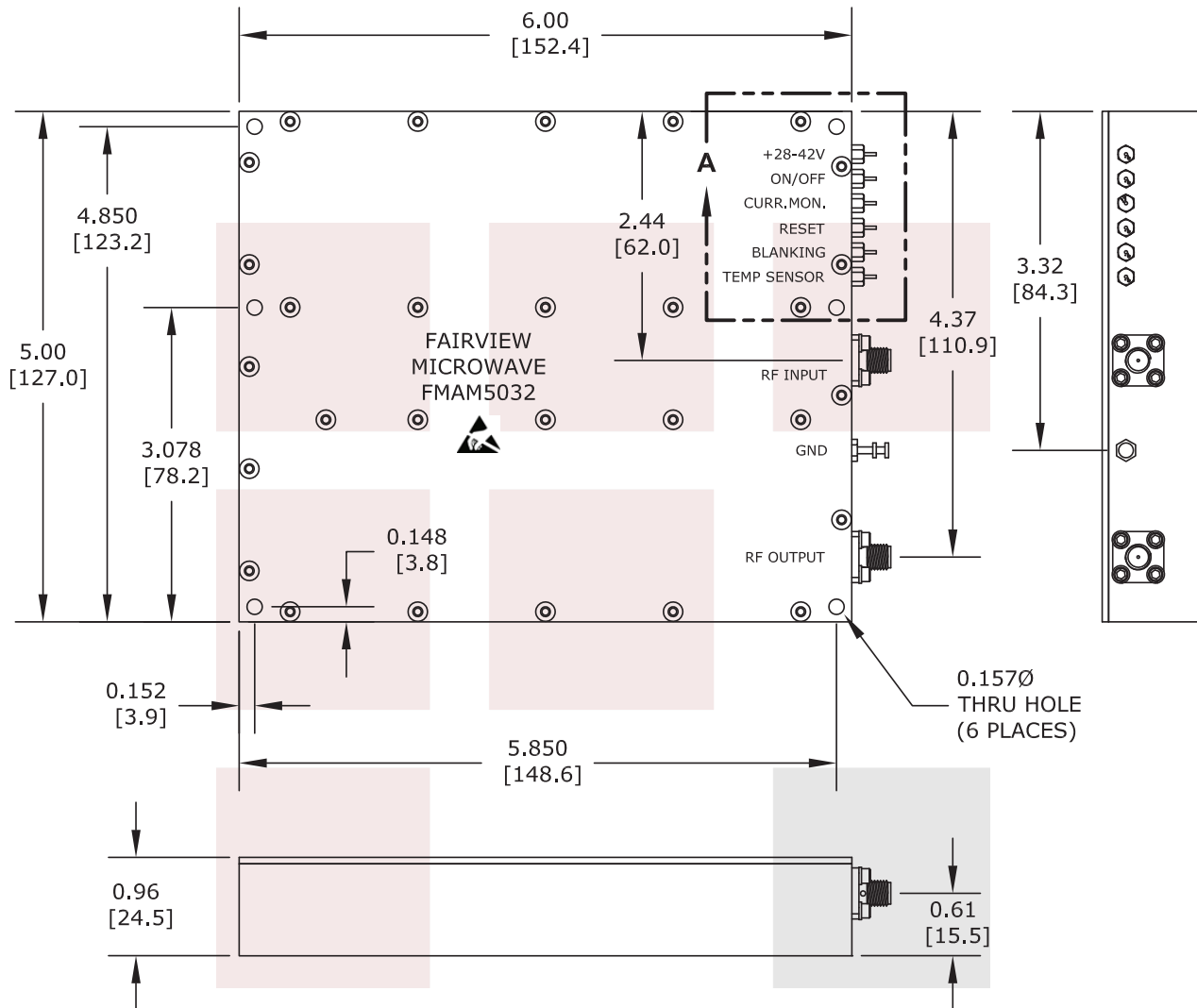

NOTE:
HEAT SINK REQUIRED FOR PROPER OPERATION,
UNIT IS COOLED BY CONDUCTING TO HEAT SINK.

FAIRVIEW MICROWAVE INC. ALLEN, TX 75013 WWW.FAIRVIEWMICROWAVE.COM		NOTES: 1. UNLESS OTHERWISE SPECIFIED ALL DIMENSIONS ARE NOMINAL. 2. ALL SPECIFICATIONS ARE SUBJECT TO CHANGE WITHOUT NOTICE AT ANY TIME. 3. DIMENSIONS ARE IN INCHES [mm].			
TITLE 48 dB Gain High Power High Gain Amplifier at 50 Watt Psat Operating From 500 MHz to 3 GHz with 52 dBm IP3 and SMA		DWG NO FMAM5032		CAGE CODE 3FKR5	
CAD FILE	042815	SHEET	SCALE	N/A	SIZE A 2233

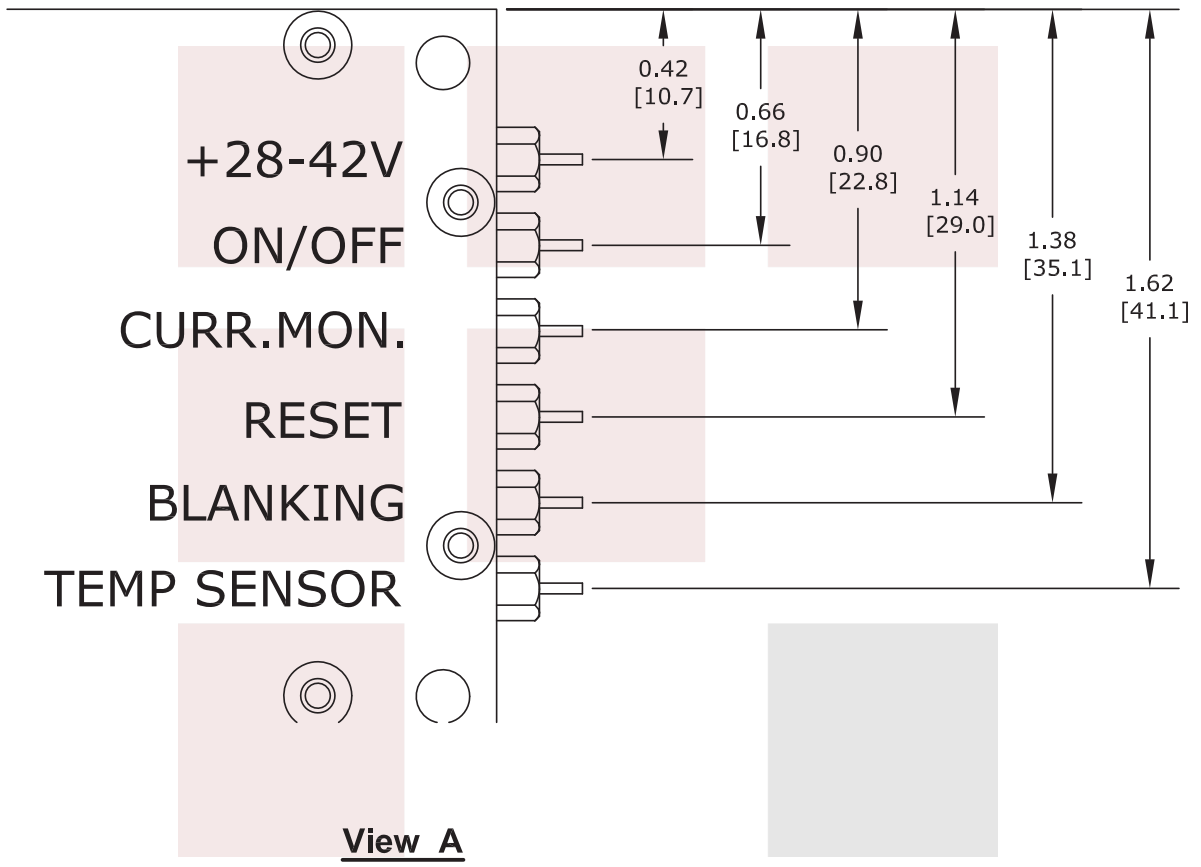

NOTE:
 HEAT SINK REQUIRED FOR PROPER OPERATION,
 UNIT IS COOLED BY CONDUCTING TO HEAT SINK.

FAIRVIEW MICROWAVE INC. ALLEN, TX 75013 WWW.FAIRVIEWMICROWAVE.COM		NOTES: 1. UNLESS OTHERWISE SPECIFIED ALL DIMENSIONS ARE NOMINAL. 2. ALL SPECIFICATIONS ARE SUBJECT TO CHANGE WITHOUT NOTICE AT ANY TIME. 3. DIMENSIONS ARE IN INCHES [mm].			
TITLE 48 dB Gain High Power High Gain Amplifier at 50 Watt Psat Operating From 500 MHz to 3 GHz with 52 dBm IP3 and SMA	DWG NO FMAM5032		CAGE CODE 3FKR5		
	CAD FILE 042815	SHEET	SCALE N/A	SIZE A	2233